



SIEMENS

Ingenuity for life

Siemens PLM Software

Simcenter news

Marine edition

November 2017

siemens.com/simcenter



Sailing toward a digital twin



Jan Leuridan
Senior Vice President
Simulation and Test Solutions

Welcome to this issue of Simcenter News. For many of us, this is a landmark since it is the first time we have a complete issue dedicated to the marine industry. Like other industries, the global marine industry is facing many engineering challenges at the moment, challenges that can be directly addressed by the Simcenter™ portfolio of advanced simulation and testing solutions.

Our Princess Yachts cover story is especially interesting because it takes a page out of the automotive industry and applies advanced noise, vibration and harshness (NVH) testing methods to luxury, handcrafted boats. This is a unique digital journey considering the fact that Princess Yachts is a longtime user of NX™ software for computer-aided design (CAD) and Teamcenter® software.

As in many industries, fuel efficiency improvements and stricter regulations are driving innovation in marine. One example is the Becker Mewis Duct®, a novel power-saving device, which results in significant fuel cost reductions and, of course, much less pollution. This unique device is now installed on over 1,000 ships worldwide and was developed using STAR-CCM+® software, the Simcenter computational fluid dynamics (CFD) multiphysics software.

With container ships reaching over 21,000 twenty-foot equivalent units (TEUs), the shipbuilding and marine industry are facing tough challenges in regards to overall performance improvements. There is an excellent feature article about how the China Classification Society (CCS) has opted to create a new marine engineering software using Simcenter 3D and NX. And race fans will certainly want to check out how the Simcenter portfolio helped push the innovation envelop in the development of the America's Cup Land Rover BAR racing yacht.

As many of you in the marine industry know, the creation of digital twins is not far off with many players, like Princess Yachts, already well placed in this field. We invite you to read an excellent story about the digital twin creation currently happening at Wärtsilä using our 1D solution, LMS Imagine. Lab Amesim™ software combined with industry CFD leader, STAR-CCM+ software. The resulting digital twin the engineers have created is not the future of the marine industry. It is the present.

We hope you enjoy reading about the many ingenious examples of how the Simcenter portfolio is being used by the global marine industry. ■



In this issue

Simcenter - The digital future of marine engineering	6-7
Princess Yachts and NVH	8-13
Princess Yachts: The digital journey interview	14-17
NCE and optimized noise reduction for the US Navy	20-23
Raising the Titanic	24-27
Man Diesel & Turbo and MBSE	28-31
Land Rover BAR and Simcenter	32-33
The secret is CFD	34-37
The route to smarter ships: Chinese Classification Society	38-39
Siemens marine and LMS Amesim	40-42
Saving millions with a Becker Mewis Duct	46-49
Wärtsilä and the digital twin	50-53

Marine magic: This is not a boat.

Gliding along on carbon-composite hydrofoil fins at surreal speeds over 50 miles-per-hour (MPH), the Land Rover BAR America's Cup entry, christened Rita, really does take a page out of the world of aviation with its carbon-fiber hull, wings instead of sails, and over a kilometer (km) of electric cabling connecting 190 sensors and four video cameras. Competitive sailing has gone high tech.

Clearly, the race is no longer just about naval architecture and straightforward boat building; competing successfully all comes down to the design and engineering of the systems, electronics, hydraulics, on-board computers and software.

Like other America's Cup teams, Land Rover BAR developed a majority of the boat virtually, using data collected by all those sensors to feed into accurate virtual simulations. The engineers no longer needed the sailing team to physically test the boat all the time. They were able to test the boat's most crucial components like the hydrofoils using a simulated digital twin.

Digital twins and data analytics aside, it still took 120 marine experts three years, four test boats, and 85,000 hours of design and build, on-water testing, and final construction to complete Rita, a true feat of marine engineering in a 15-meter long package.

Of course, Simcenter played a role. Check out the Land Rover BAR feature to learn how the Simcenter tools played a critical role in the digital journey that created Rita. And catch the interview with CFD pioneers, Cape Horn Engineering, for an insider's chat with industry experts.

➤ [Land Rover BAR page 32](#)

➤ [Cape Horn Engineering page 34](#)

Land Rover BAR





Simcenter

The digital future of marine engineering

“Prediction is very difficult, especially if it’s about the future,” said the late Niels Bohr. The eminent scientist is just one of the historical figures to whom this quote has been attributed. And indeed, could Bohr, the 37-year-old Nobel Prize winner for physics, have predicted that barely 20 years later he and his close friend Werner Heisenberg would find themselves in opposite camps of a nuclear arms race that still largely defines the world order as it is today? Could he have imagined that his scientific findings would become the foundation to what is probably the most controversial energy source in human history? Or everyday applications, such as the microwave oven or the DVD player?

State-of-the-art is temporary by definition, just like Bohr’s atom model turned out to be. And it’s hard to predict exactly which applications, enabled by technologies that are available today, will shape the future. In the marine industry, there is no other option than to look far ahead. The design and construction phases of ships already take several years, and are usually followed by a service life of multiple decades. Add to that the fact that vessels will have to satisfy global transportation needs in a world that is rapidly changing in terms of environment, demographics,

economy, and natural resources. It becomes clear that during design, the goal is to try and convert today’s technologies into applications that will be required in 2030 and later. Digital technologies are powerful tools that are used across transportation industries, and it will be exciting to see if and how these technologies lead to applications that will provide an answer to future challenges.

The pressure on energy efficiency

We all play a role when it comes to protecting the future of our planet. Today, the marine industry is responsible for about 2.5 percent of global carbon dioxide (CO₂) emissions according to the International Maritime Organization (IMO). That is more than the entire contribution of Germany, or France and the United Kingdom (UK) combined. Any predicted growth in the marine sector in the coming decades is in direct conflict with the Paris Agreement on climate change, which specifies that halving worldwide emissions by 2050 will be required to keep the global temperature increase below 2° Celcius (C) compared to preindustrial times. The IMO has responded to this challenge, implementing stricter regulations on ship emissions via the Energy Efficiency Design Index (EEDI). By 2025, new ship designs must be 30 percent more efficient

than a ship built in 2014. On top of that, the new European Union (EU) Monitoring, Reporting, Verification (MRV) regulations require ship owners and operators to monitor and report their CO₂ emissions, with even stricter limits than the IMO regulations. Also, companies are trying to beat the required targets with their own initiatives. All this leads to challenging engineering targets for naval architects.

Meanwhile, the marine sector can expect busy times ahead. Major players within the marine industry spend great effort making forecasts based on global trends in order to plan engineering efforts and to set business expectations. These forecasts include scenarios for disruptive events that might impact marine transportation requirements, such as natural disasters, or military conflicts. These forecasts all confirm the world economy will most likely continue to expand as developing regions further emerge. This should dramatically increase the transportation demand for resources and goods, and open up more opportunities for commercial shipping. At the same time, this evolution could affect geopolitics as well, and lead to more military action at sea during future conflicts. That would, of course, be a threat to stability and peace, but could also bring additional business for naval suppliers.

With the increased awareness of environmental responsibility, and predicted growth in marine transport traffic, fuel economy will become a top priority and function-critical design aspect for marine engineering during the coming decades. According to the IMO, significant fuel savings could already be made by fully exploiting existing technologies, and copying other transportation sectors. Yet further innovations will be required to meet global expectations. These could come from new powering methods for propulsion systems, improved vessel performance through weight reduction, fluid-structure interaction (FSI) optimization, enhanced speed management systems or from considering the complete transportation fleet instead of looking at individual vessels. Whichever solutions appear, it's clear that digital technologies will play a crucial role, either during design, as part of the solution, or to make data-driven decisions on the integrated vessel or fleet.

A changing vision on doing business

Fuel consumption is obviously not only an environmental consideration; it is a substantial part of a vessel's operational cost as well. Providing an energy efficient solution can serve a higher economic goal, which is an important factor in the financially competitive marine sector. Vessel orders are usually large investments and quite a big risk for fleet owners, especially those who are into the cyclical shipping business. Any economic recession can strike very hard. For this reason, shipbuilders can gain a competitive edge by rethinking their customer relationship. Rather than selling vessels as direct deliveries, they can offer partnership models and take a broader responsibility regarding the entire vessel lifecycle. For fuel consumption, that means, aside from delivering an energy efficient solution from the start, the shipbuilder could provide continuous improvement through updates and services.

And one could make similar commitments for maintenance and operations. Just imagine how much fleet owners could save if maintenance could be scheduled based on a measured condition, rather than on a clock, calendar or runtime meters. This condition-based maintenance (CBM) could be automated by continuously collecting data from sensors inside the vessel and sending it for analysis at an onshore center. The same data could be used to validate the simulation models used to create the original design, both increasing confidence in the simulated prediction and providing more accurate operating conditions for design alterations on existing vessels. A process like this would maximize the vessel's useful life and reduce cost by avoiding downtime. Or it could even go a few steps further. Imagine if you could offer your customers a fully autonomous vessel that can monitor and report its health, as well as gather information from the environment, and use it to make autonomous decisions, such as navigating safely and avoiding collisions?

Smart applications that go this far may not be mainstream practice in marine yet. But the technologies they require already exist to a large extent, and are widely applied in the automotive and aviation sectors. So the question is how to implement this knowhow in marine-specific operational

continue reading on page 54



Sailing on the waves of silence

From the moment you step on board, you enter a world of exceptional luxury. From the stunning curve of the flybridge stairs to the subtle leather handstitching on the stateroom railing, a Princess yacht is designed with pure perfection in mind. And this, of course, includes its engineering performance.

Quite common in the automotive market, acoustic performance has become a significant differentiator when it comes to considering a new purchase in all kinds of industries, including the luxury yacht market. That being said, the luxury yacht market is still one of customization and artisanal craftsmanship. Every single Princess yacht is unique and this makes noise, harshness and vibration (NVH) engineering and perfecting the overall acoustic performance, both inside and outside, a tremendous challenge.

This is where Michal Tomaszczyk, an NVH engineer at Princess Yachts, steps into the picture. Tomaszczyk started to work on NVH thanks to the TRANQuil project, a 3-year research project with Princess Yachts, The University of Southampton and TBG Solutions, that focused on innovation, like an active noise control system, to overcome noise and vibration issues caused by secondary generators on yachts.

“Princess Yachts is my first great engineering challenge,” says Tomaszczyk. “Right after university, I was given the task to investigate and integrate NVH tools and processes into our production process. We are very fortunate at Princess because we have great people with vast experience constructing luxury yachts so they are more than capable of building the best product using best practices and years of artisanal experience and specialty skills. That being said, there really wasn’t too much NVH data to start from.”

One size doesn’t fit all

Practically every Princess yacht is handcrafted to the customer’s exact specifications and this creates a plethora of unique NVH challenges. But like other industries, yacht construction is undergoing a revolution in design as well as production. Besides streamlining the simulation and design process and coordinating with suppliers, the Princess Yachts team needs to account for different engine options, interior elements and an entire realm of new materials, including cutting-edge composites.

»In my opinion, our new testing process, based on LMS testing solutions, has changed how we work dramatically.«

Michal Tomaszczyk

NVH Engineer, Princess Yachts



“Not so long ago, we dispatched a super-specified Princess 35-meter, which was ordered by a customer in Russia,” explains Tomaszczyk. “The boat has dark furniture, lots of chandeliers and special features. It is beautiful, but every boat is decorated individually. We handle a variety of special requests and customized elements. You can imagine what this does to our testing process.

“And we use five main engine manufacturers: Volvo, Cummins, MAN, MTU and Caterpillar. All these engine options add their own signature in the yacht, which is custom built. So there are a lot of variables to test. It is important to prevent the noise and vibration from influencing the hull of the yacht itself, and in turn, the yachting experience. This is our main job.

“Princess invested very heavily in development last year. Projects like TRANQuil allowed us to choose partners that would really push our capabilities forward and not just provide the equipment. We needed an NVH strategic plan as well as an NVH quality plan. Today, we have this and the constant support from the Siemens PLM Software team in the UK.”

Modal testing for plywood and composites

One of the new areas that Princess Yachts works on is looking at how sound energy radiates through plywood and composite panels that are used in the bulkhead. The idea is to study the sound fields and display panel attenuation easily. A dedicated testing facility has been built in one of the factory units in Plymouth, United Kingdom (UK). This is practical, but also means that background noise needs to be taken into consideration when measuring the sound field.

“You could call my testing environment rather unique,” says Tomaszczyk. “The process of building a yacht is still very hands on. As an engineer, you have to be on the floor and right in the process. You can imagine there is a lot of noise. People are sanding wood, hammering and sawing. With all this action, we have to think about clever ways to get things tested. One example is that we use sound-directional techniques, which makes our testing unsusceptible to background noise.”

For panel testing, Tomaszczyk sets up a typical test using microphones, an intensity probe to find the transmission

»We really feel that the Simcenter simulation capabilities and having a digital twin will benefit us in the near future.«

Michal Tomaszczyk

Image courtesy of Princess Yachts Limited



The Panel testing facility or PTF in factory unit in Plymouth, UK is made of more than 3.5 tons of concrete. It is a mini-version of a two-chamber anechoic/reverb setup.

loss and the LMS SCADAS™ Recorder hardware 16-channel data acquisition solution, which can be used remotely thanks to its flash drive and internal battery.

“Testing a panel like this is especially interesting on the supply side to confirm performance before we put it on the yacht,” says Tomaszczyk. “We use the LMS Test.Lab software and LMS SCADAS equipment here. It works flawlessly. It is a very robust solution.”

The ever-important sea trial

Every single Princess yacht must undergo strict, multiple sea trials prior to delivery. During the trials, Tomaszczyk is

hard at work on-board taking measurements as the yacht is put through its paces to guarantee excellent performance.

“There are many data acquisition systems available on the market, but we have a saying at Princess, ‘Good is not good enough,’” says Tomaszczyk. “We not only wanted a good and effective testing solution, we wanted the best. A single NVH test on a multi-million pound M Class yacht takes a minimum of seven hours. You can imagine it is very important to have a testing system that is tough, versatile and highly dependable. You have to work fast and you don’t want to repeat the measurements.”

Modal characterization of plywood panel

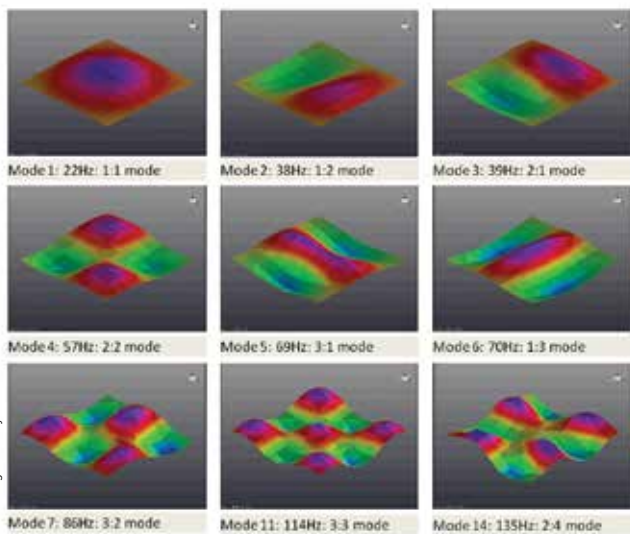
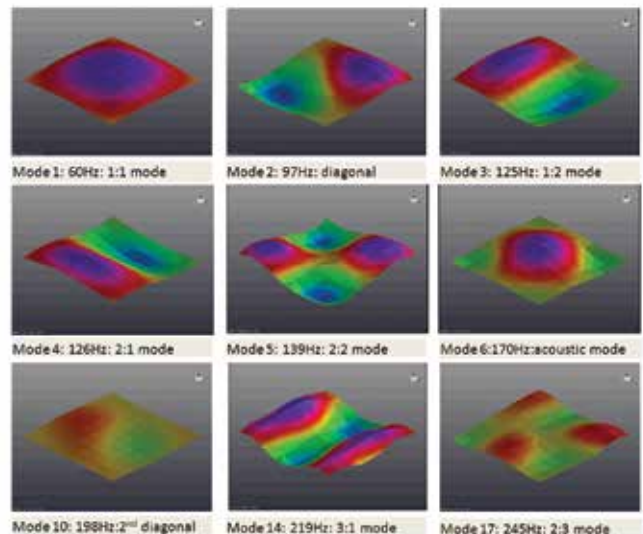

Image courtesy of Princess Yachts Limited

Modal characterization of composite panel



One new NVH area that Princess Yachts works on is comparing how sound energy radiates through plywood and composite panels that are used in the bulkhead. A dedicated testing facility was built to acquire data and study the sound fields to compare and display panel attenuation more easily.



Image courtesy of Princess Yachts Limited

Princess Yachts uses five main engine manufacturers. All these different engine options add their own sound signature to the yacht. This potentially creates dozens of test configurations.

The LMS SCADAS Recorder is an ideal tool for sea trials. Not only does it meet the stringent military standard (MIL-STD) 810F specifications, which means it can easily handle rough sea conditions, it can also record data on the fly without a personal computer (PC) connection. Ideal for mobile use, LMS Smart™ software on the tablet can be used to take quick measurements in addition to the Global Positioning System (GPS) functionality, which is a great way to track speed versus turning angles and other maneuvers at sea.

“On the sea, I instrument the entire yacht with sensors, paying special attention to the engines, gearboxes and mufflers,” says Tomaszczyk. “We measure the vibrations and look at various correlations like the helm and the rotating machinery. We also conduct acoustic measurements in critical areas, like the master bedroom and staterooms, to make sure that the yachting experience is exceptional and that disturbing noise is minimal. As far as I know, no other yacht manufacturer has such a comprehensive NVH program.”

The one-man test department

In addition to LMS SCADAS, Tomaszczyk appreciates automation features, like the LMS Test.Lab™ software advanced signature testing worksheet. This worksheet provides a set of standard analysis tools to quickly identify the source of noise and vibration issues related to rotating machinery, hydrodynamic effects or other auxiliary systems on the yacht.

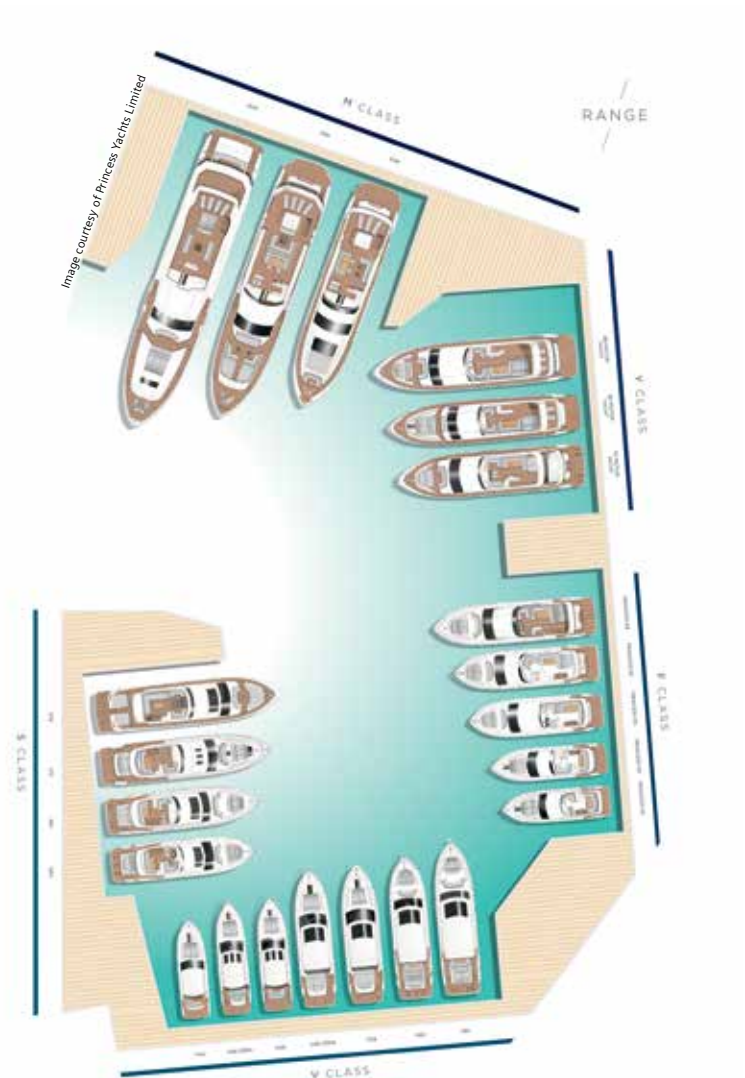

“Our whole production process is centralized in Teamcenter, which makes it easily accessible for everyone involved in design, development, construction and delivery of the yacht,” says Tomaszczyk. “Having the LMS testing solution aligned to the entire process will help minimize the ‘monkey jobs,’ so to speak. It leaves much more time for larger scale test campaigns.

“To give an example, the NVH report for the Princess 40-meter is more than 40 pages. There is quite a lot of data to manage and the reporting capabilities in LMS Test.Lab really help to automate this process. This wasn’t possible before.”

The Simcenter advantage

In the future, the team is looking at integrating more of the Simcenter portfolio. “We really feel that having the Simcenter simulation capabilities and a digital twin will

benefit us in the near future,” says Tomaszczyk. “This will bring more transparency to the overall engineering process so that the data acquired during testing can help improve the simulation of future yacht designs.

“In my opinion, our new testing process based on LMS testing solutions has dramatically changed how we work. First of all, we are able to communicate effectively with other NVH engineers on the supply side. We can interpret the specs, and apply measurement techniques to set NVH targets. This is a huge market advantage because each and every one of the approximately 250 yachts we create annually must be of the highest possible quality.

“As market leaders, our main challenge is to stay ahead of the competition. Our customers are starting to appreciate the distinctive NVH qualities of Princess yachts. As an NVH engineer, this makes my day.” ■



»Our customers are starting to appreciate the distinctive NVH qualities of Princess yachts. As an NVH engineer, this makes my day.«

Michal Tomaszczyk

The digital journey interview

Nick Williamson, director of development at Princess Yachts, tells us how simulation and testing solutions support the artisanal production experience that is at the core of this market-leading luxury yacht manufacturer.

Image courtesy of Princess Yachts Limited



Nick, you have had quite a career at Princess Yachts.

I started at Princess Yachts 33 years ago as a carpenter on the shop floor, moved through supervision and production, and then moved to development as a supervisor. I worked my way from there to director of development, which is where I am today.

Over your 33 years of development experience, you have seen an enormous amount of change.

When I first came to development, we would just use manual skills and manual labor. We'd start with a 2D drawing from our design team, which was one designer at the time, and we would scale that up. After that, we would make a mockup out of plywood. Then there was a period where we would adjust the mockup: an inch taller there and an inch wider here. After the full-sized mockup was approved by the directors, we would take it apart and take it over to our furniture factory and physically draw around the pieces to manufacture the parts.

Today we have moved on from there to a very comprehensive, almost full 3D model that generates CAD data that we use for tool pathing to manufacture our furniture. We have a 5-axis output as well, so we 5-axis all our major and small moldings. From the time I started, development has massively changed. It is a 360-degree turnaround.

What challenges you today regarding simulation and digitalization?

Keeping the core brand value and the feeling of a handcrafted boat. When you buy a Princess yacht, you are buying a luxury item. It is important that it doesn't feel mass manufactured or created from the digital world.

So the biggest challenge is integrating those artisanal skills into the finished product. We do this by integrating manufacturing into our development process. It is a gated process. The skilled craftsmen that actually build the boats get fully involved. We pretty much let the designers run free and then we undesign it back to a point where it is a beautiful product that can actually be manufactured.

Are there certain tools that you count on to do this?

The tools we depend on most are NX and obviously Teamcenter because of the version control. We can see where we come from and where we want to go. The views we generate are ones that the craftsmen are able to easily understand. Although they are great craftsmen, they might not necessarily understand a complex 3D model or the variety of views typical for 3D models. It is important to present the information to them so that they can have an impact. And our craftsmen do.



Nick Williamson, director of development at Princess Yachts

We are currently market leaders. This is down to our guys on the floor having an input and down to our designers pushing the envelope. It is a great place to be.

How has the team itself changed?

It used to be a handful of people. At one time I had 24 carpenters and three engineers working on development. Now I have less than that in terms of carpenters, more than that in terms of engineers and in terms of full CAD staff, I have 93 currently. It is a large operation. The schedule and the amount of models that we are developing have rapidly, rapidly increased.

Besides the CAD world, what other areas do your engineers cover?

We do a lot of naval architecture in-house. We do NVH studies in-house, which is one of the improvements along our digital journey. We do some FEA in-house, but we

are really just starting in this area and constantly improving. All our hulls are fully CFD-tested and it has led to quite some fundamental innovation in regards to our hull design. We also use CFD in terms of airflow and this seems to work well.

Basically, if you are traveling at 25 knots and drinking a gin and tonic, you want to have a pleasant and comfortable experience. You don't necessarily want the wind in your hair. This is what makes a great product. This is what makes a difference.

Princess Yachts is market leader. How will you and your team help maintain this leading position?

It is always easier to be a follower and much more difficult to be a leader. This is where we are now. Throughout the business, we are transforming the way we work. To keep ahead of the rest of the pack, we need to

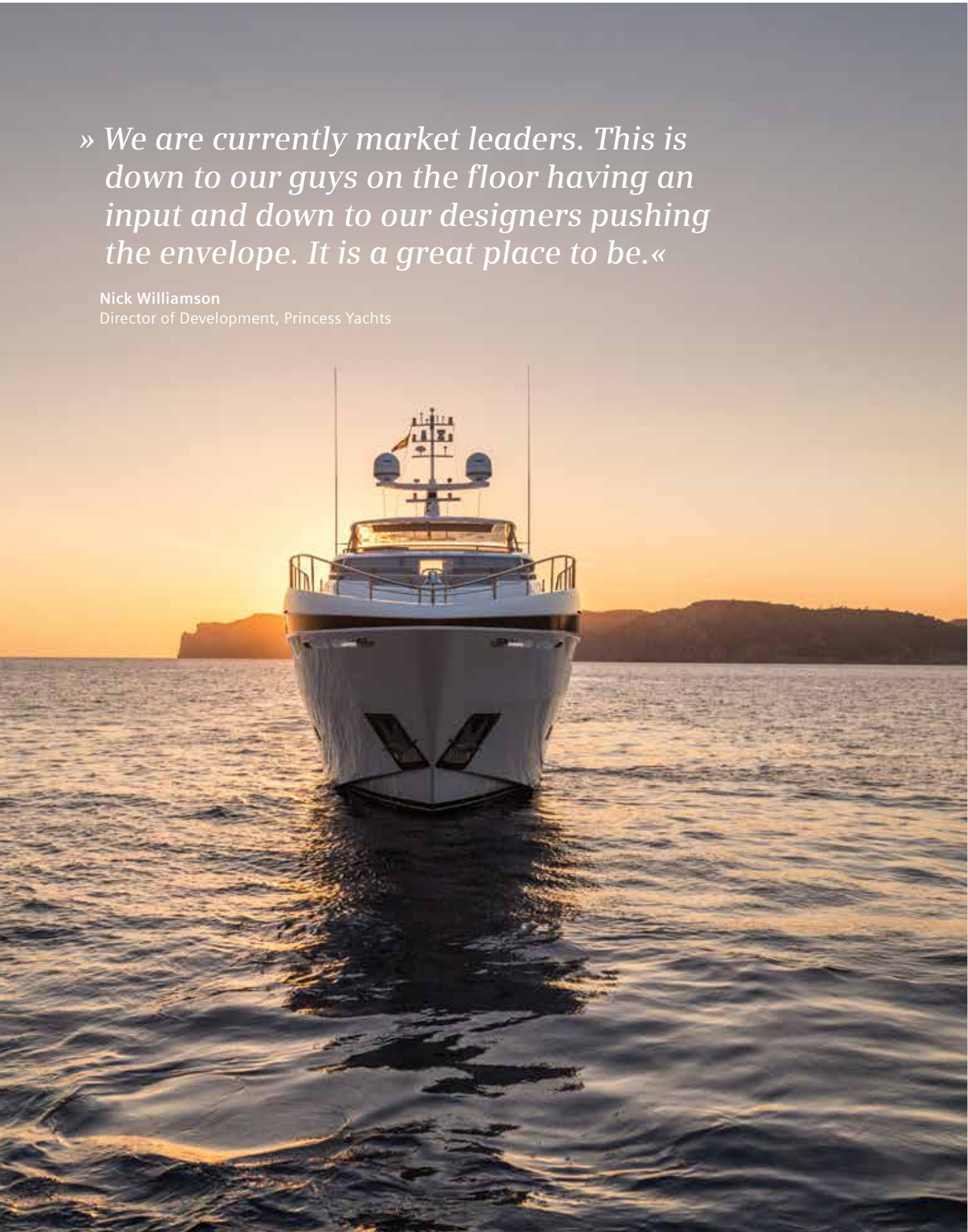

Image courtesy of Princess Yachts Limited

The naval architects at Princess Yachts count on 3D CAD models created in NX.

» We are currently market leaders. This is down to our guys on the floor having an input and down to our designers pushing the envelope. It is a great place to be.«

Nick Williamson
Director of Development, Princess Yachts



continue the integration, and continue to build on our tools. We need to keep our core brand values and our core craftsmanship visible in the product. These are things that I feel we are currently doing well.

In terms of new products, we are fundamentally changing the range as we go. There are no old products at Princess Yachts. All the products are continually updated and continually upgrading.

You have a long-term partnership with Siemens PLM Software and are longtime users of NX CAD and Teamcenter tools. What are the key advantages of your digital journey so far?

For Princess Yachts, the core advantage is that we can simulate and build the boat in 3D before we start. We are making the mistakes in the virtual world and not the real world. We are discovering solutions to problems that have been longstanding in the marine industry. We are gaining on this knowledge and this advantage is visible in the final product.

The version control is great in terms of Teamcenter. It does help us integrate the shop floor and make a better product from the start. In the marine industry, with yachts the price they are, we can't afford to get things wrong. We don't get a preproduction run. Our first boat is a customer's boat and that customer deserves the same quality as if it was boat 50.

How do you get your craftsmen up-to-speed with the changes in your digital environment?

We have constant reviews and constant team integration. We have project meetings once or twice a week where everyone will see the 3D models on the screen. The more you are exposed to this, the more you learn.

Will CAE take a similar digital journey at Princess Yachts?

Compared to our CAD knowledge, we are infants in the CAE world. But going forward, we will be modeling our systems and testing them online – almost in a FEA style – to insure our systems are fully integrated with some of the beautiful designs we are producing.

You are currently doing some pretty impressive NVH work at Princess Yachts. What role will NVH testing continue to play?

Michal has been working with us doing NVH for three years now. He has taken us from nothing to quite an impressive range of data that we are gathering throughout the range. We are using this data to understand how the structure affects the vibration and the noise that you hear onboard.

All this improves the customer experience on the boat. We use this data in upcoming designs. NVH will set the benchmark for structure and, in a sense, the customer experience on the boat.

What is the overall role of testing and test data in your final product?

Our testing affects the specifications and performance data that we give to customers. It gives us a competitive advantage when we know that we can achieve what we say we can achieve.

In light of this, will you be developing a digital twin backed by verified data for each boat you deliver?

We develop our version of a digital twin for our M Class yachts. This process will get better as time goes on. As we grow into this new technology, it will also backfill through the rest of the range. As we develop new products, it will become part of the process. It will happen in a natural way over a period of time.

How important is the role of NVH?

It's a little like what I said about CFD and enjoying your gin and tonic at 25 knots. If you can get your NVH right and get it to the correct standard, you are now enjoying your gin and tonic at a nice smooth level pace without hearing the noise of diesel engines, or structural or airborne noise around you. So NVH is very important.

As you start to use more Simcenter tools, how will this change your development process?

It wouldn't fundamentally change the way we develop a Princess yacht. What it would do, in my opinion, is allow us to test all the systems and integrate all the systems in the design properly so that there is a 100 percent test of the boat in the virtual world before we start to physically build the boat.

Taking in your 33 years of experience at Princess Yachts, where would you like to see the digital journey go in the future?

What I didn't mention before is that although we do the full 3D model and full 3D CAD and the digital tool paths, the furniture and the major molds, we also still do a full mock-up that you can physically walk around prior to production. This ensures that you get the feel of a yacht before we build it using the experience of our customers and the artisanal craftsmen within the business. I believe that we can remain market leaders if we can get the artisanal craftsmanship to continue along with our digital journey. Then we can enjoy many more years of success at Princess Yachts. ■

Simcenter 3D provides generative design and expanded technology for better industry workflows

Making sure the performance of complex mechanical systems matches requirements before the prototyping phase is a challenging task. Product engineers have to consider the influence of real-life conditions, such as frictional forces, inertia effect, applied loads and the operational temperature to develop products that are durable, efficient, quiet and environmentally friendly.



Miniaturizing sensors and making them more affordable is transforming modest electromechanical products into smart devices, but that complicates the product engineering and certification process even more. To streamline product performance engineering and increase simulation fidelity, engineering departments are turning to Simcenter 3D for a unified, scalable, open and extensible environment for 3D CAE. The Simcenter 3D v12 release adds new solutions that will help users generate and explore new designs. This will also expand and integrate an impressive array of new technologies, such as advanced nonlinear solutions, discipline- and industry-specific modeling and postprocessing enhancements that combine to help engineers be more productive.

Unleashing generative design potential

Numerous new capabilities in combination with NX CAD and HEEDS™ software facilitates generative design. Generative design is a computational paradigm in which the design takes shape based on the rapid exploration and evolution of design parameters. This improves performance based on requirement statements and restraints. New topology optimization, powered by NX™ Nastran® software, helps create innovative, lightweight design shapes that are based on structural performance results that can include multiple load cases and manufacturing constraints. In addition to topology

optimization, convergent modeling techniques available in Simcenter 3D break the barrier between faceted and boundary represented (b-rep) CAD data. This allows designers and analysts to edit faceted geometries, like results geometry from topology optimization, legacy FE mesh data file or scan data, morph it into new geometry, remesh and re-analyze performance for an overall faster end-to-end process.

Technology integration

Version 12 integrates capabilities from legacy simulation tools like LMS Virtual.Lab™ software and LMS Samtech Samcef™ software. For example, motion simulation adds an efficient analytical contact formulation to quickly compute interacting contact forces reliably in a short time compared to the existing 3D CAD geometry contact definition. Sphere-to-sphere, sphere-to-extrusion, sphere-to-revolution, extrusion-to-revolution, revolution-to-revolution, sphere-to-rail analytical contacts are made available. A model definition file (.mdef), a text-based motion model, lets users define motion mechanism without accessing the Simcenter interface. With lightweight installation, command line solver execution and a standalone post-processing tool for motion results, the text-file based technology lets Simcenter motion users develop vertical applications by adopting all solver features. For acoustics, the new acoustic transfer vectors (ATV) in this version drastically reduces automotive, marine, and

locomotive powertrain radiation computation time. Finite element method adaptive order (FEMAO), fast multipole boundary element acoustics (BEM) and H-matrix BEM are added to solve acoustic problems, like automotive pass-by noise (PBN) and aircraft fly-over noise, that require larger acoustics models. Acoustic transmission loss from muffler and body panels can also be effectively simulated. Using a hybrid approach, measurement data from a component or subsystem can be brought into a system-level NVH simulation to improve simulation speed and fidelity. To address highly non-linear problems, Simcenter 3D enriches its nonlinear capabilities, such as the new multi-step nonlinear solutions in NX Nastran, and the finite-strain and composite-curing solutions in LMS Samcef. Finally new pre- and postprocessing like rule-based, selection recipes can help engineers automate modeling processes and improve productivity.

Industry workflows

Siemens builds decades of industry experience and expertise into its products. Just one example of this is a vertical application for airframe structure analysis, Simcenter Aerostructure, a simulation solution allowing traceability of data and results while maintaining consistent global process control. Simcenter 3D v12 is full of ingenious innovation like this as well as new features that enhance industry-specific workflows for airframe, space, automotive and electronics. ■

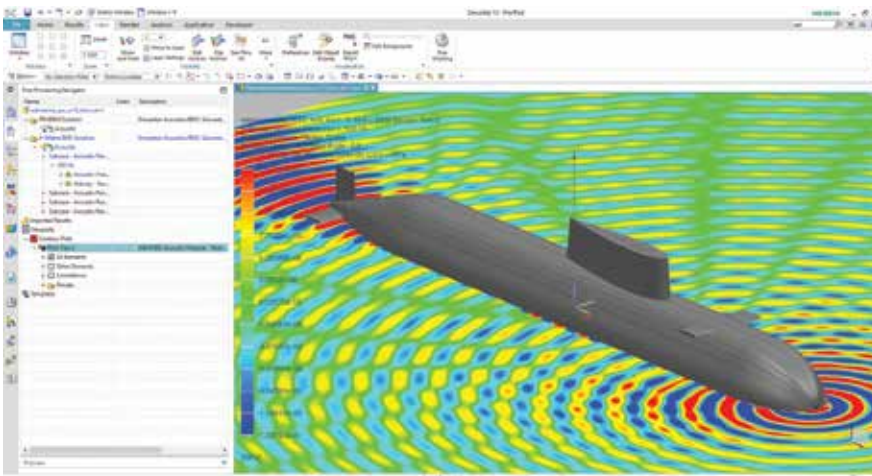

Simulation of the reflection by a submarine structure to an acoustic source (eg. sonar).

“We hear you loud and clear”

Simcenter testing tools and services help the U.S. Navy improve working conditions for aircraft carrier crews.



A serene working environment is not the first thing that comes to mind when you think of United States (U.S.) Navy aircraft carriers. More likely, you'll picture an F-18 swooping in for a touch-and-go landing amid the shudder of a near-sonic boom.

For the more than 5,000 sailors aboard a typical U.S. Navy aircraft carrier like the United States Ship (USS) Dwight D. Eisenhower (CVN 69), excessive noise is unfortunately part of the job. The U.S. Navy realized they needed to address this issue. Noise levels on the flight deck easily exceed 150 decibels (dBA) in many areas during takeoff. Constant exposure to high sound levels can affect the aircraft personnel's health and well-being and can lead to noise-induced hearing loss (NIHL). The figures reported by the U.S. Department of Veterans Affairs are quite alarming: NIHL and tinnitus are by far the most prevalent disabilities in the U.S. Armed Forces, with more than 1.5 million affected veterans. This figure is three times higher than disabilities from other afflictions such as post-traumatic stress syndrome. Even worse is the fact that most NIHL cases can take up to 15 years to surface.

Currently, NIHL represents one of the largest expenses for the U.S. Department of Veterans Affairs, which according to some calculations is over \$3 billion in claims annually. In addition, there is the impact on individual day-to-day life and operational performance.

This is not a new problem. The Office of Naval Research (ONR) is the research arm of the U.S. Navy and is one of Noise Control Engineering (NCE) LLC's principal clients. Kurt Yankaskas, NIHL program manager for ONR's Warfighter Performance Office, has been battling hearing loss in the U.S. Navy for many years, and has funded numerous NIHL projects, including this one. However, this is the first time that serious action has been taken to reduce noise in aircraft carrier spaces and attack the cause of NIHL head-on. But just addressing the flight deck, where the most effective option is hearing protection, wasn't enough. Aircraft noise also permeates into the lower gallery decks – just under the flight deck – where many crew members live and work. Even in these spaces, the sound level exceeded the U.S. Navy eight-hour exposure limits of 85 dBA. Finding a universal way to reduce noise level throughout the entire aircraft carrier would have the most impact.

To help address this challenge, the U.S. Navy contracted NCE, an acoustic engineering consulting firm specializing in noise and vibration measurement and control for marine applications. NCE Senior Engineer Jeffrey Komrower decided to follow a pragmatic and well-proven approach to validate noise reduction techniques on the Eisenhower

"The noise levels are very high on aircraft carriers," Komrower explains. "In many of the offices and staterooms below the flight deck, levels exceed 85 dBA and have been measured as high as 105 dBA during launch events. The other issue is these spaces are typically highly reverberant, making the situation worse. To reduce the noise successfully, it was important that we understood what the dominant noise sources were and how the acoustic energy flows from sources into the ship compartments.

"In this project, we combined simulation and measurement techniques to accurately model the physical system and come



up with the optimal noise control treatment schemes in terms of effectiveness, cost and weight. "These treatments were applied to several spaces on the Eisenhower to test out the effectiveness, with the intent of installing them on the rest of the fleet as they go into their maintenance periods."

First simulate...

The ship structure was modeled using Designer-NOISE® software, a program designed exclusively by NCE. This proprietary software, which was initially developed as part of the U.S. Navy's Small Business Innovative Research (SBIR) program, is used to quickly and accurately predict the noise levels on ships. It has been used successfully in more than 100 commercial and military programs. Its core solver uses a hybrid statistical energy analysis (SEA) approach to predict the spread of noise and vibration throughout the vessel. All that is required is a relatively simple description of the vessel based on the physical properties of the decks, bulkheads, insulation material and joiner facings. Solver time is a matter of minutes, which means that Komrower and his team can work quickly.

"Our software is designed to study large ships when you don't have time for complicated or overnight solver work," says Komrower. "We easily perform rapid tradeoff studies

comparing the various potential noise control treatments while keeping a high accuracy level. After we predict the relative contribution of the different surfaces to the overall noise level in the compartment, we evaluate various noise control treatments, including absorptive insulation as well as high-transmission loss and damping materials. We estimate the efficiency of each treatment in terms of acoustic performance, but also in terms of cost, weight and installation complexity.

...then test

Like every engineer, Komrower knows the value of testing, and the next step in the process involved validating the simulated conclusions by performing measurements on selected areas of the aircraft carrier. The compartments on the gallery deck, just under the catapult No. 2 launch area and extending to the area under jet blast deflector (JBD) No. 2, were ideal since the noise levels here were the highest on the gallery deck during flight operations. More than 100 channels of instrumentation, including microphones and accelerometers, were distributed throughout the flight and gallery deck to acquire data for more than 100 launches of tactical jet aircraft. To tackle this challenging job, Komrower relied on the high-performance LMS SCADAS Mobile hardware data acquisition system and LMS Test.Lab software.

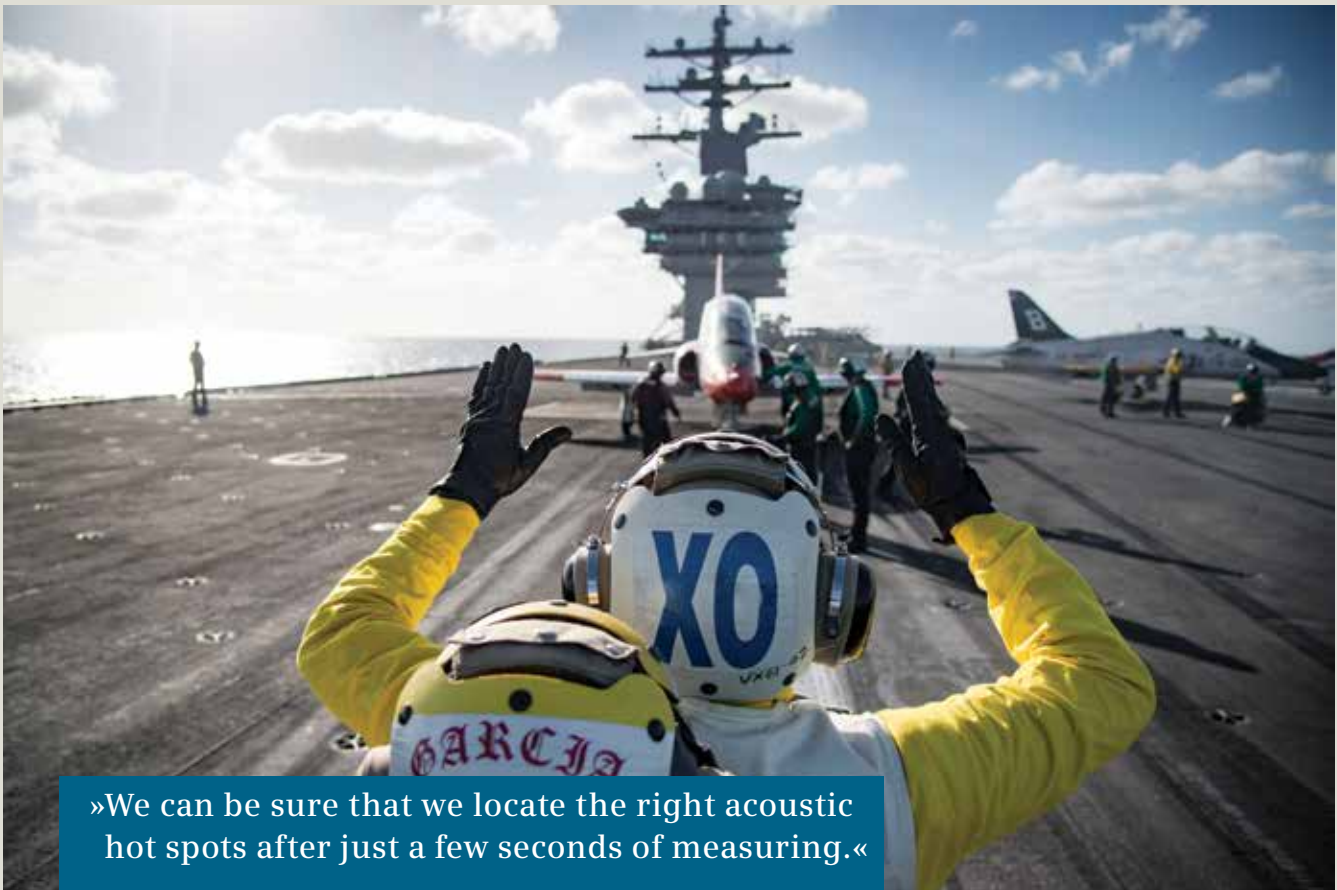

»We can be sure that we locate the right acoustic hot spots after just a few seconds of measuring.«

Jeffrey Komrower
Senior Engineer, Noise Control Engineering LLC

U.S. Navy photo by Mass Communication Specialist 3rd Class Anderson W. Branch

“Because it is ultra-compact and highly precise for conducting signal conditioning for a large number of acoustics and vibration channels, LMS SCADAS Mobile hardware was definitely ideal for the job,” says Komrower. “We validated the aircraft source levels directly from on-deck microphones and measured the resulting noise levels in the gallery deck spaces. We also had accelerometers on the flight deck underside and ship bulkheads to measure transmitted vibration levels, which could re-radiate as acoustic energy into the spaces. This data was then postprocessed and analyzed using LMS Test.Lab to validate the acoustic models and the source levels.”

Innovative solution: the LMS 3D Solid Sphere Array

With the traditional measurement techniques complete, NCE sought to validate how the energy was actually getting into the spaces below deck. Because of the many possible paths (both airborne and structure-borne) and the reverberant issue, it was difficult to identify the key culprits and develop an optimized and effective noise control plan. Komrower knew he would have to try something different and innovative. This was a job for a state-of-the-art acoustic array, the LMS 3D Solid Sphere Array. Its 36 microphones capture noise from all directions and the system uses a spherical beam forming technique to indicate the path of the dominant noise sources.

“We joke that it looks like something out of a science fiction movie, but with jobs like these, it is the only way to accurately and quickly obtain a 360-degree image of a room,” says Komrower. “We can be sure that we locate the right acoustic hot spots after just a few seconds of measuring.”

For the work on the Eisenhower, Komrower used measurements taken with the LMS 3D Solid Sphere Array to determine that the primary source of noise in the spaces measured was radiation from the vibrating structural bulkheads. The high acoustic energy from the aircraft impinges on the flight deck and transmits through the ship structure, causing the bulkheads to vibrate. The high radiation efficiency of these structural bulkheads results in the vibrational energy being transmitted to high acoustic energy in the compartments.

“Simply reducing the surface vibration is typically a very effective way to reduce the overall noise,” explains Komrower. “We teamed with a company called Tech21 and decided to use their spray-on damping material on the structural bulkheads since it is lighter, easier and faster to apply than traditional damping tiles. This material was also developed under a Navy SBIR program.”

Verification of success

The project didn’t stop here. Komrower verified the material’s performance by taking measurements again after the spray-on damping had been installed. This set of measurements confirmed the predicted result from the simulation model. The noise level was reduced five-to-seven decibels in the compartments that were treated.

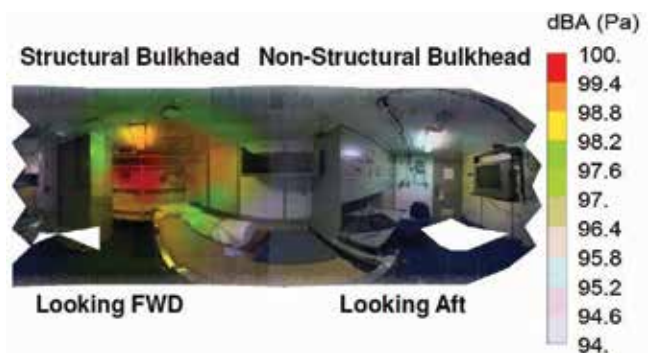

“This is an excellent result,” says Komrower. “The spray-on damping treatment was a very efficient way to obtain reductions in noise levels from flight operations in these office and berthing spaces. The LMS 3D Solid Sphere Array was an essential tool for this project. It helped us identify the exact surface areas that contributed the most to overall noise levels and made sure the acoustic hot spots were covered sufficiently with surface treatment.”

By combining simulation modeling and innovative experimental techniques using LMS testing solutions, NCE was able to successfully develop an optimized noise reduction plan for cost, weight and treatment option effectiveness. The spray-on treatment is currently being installed on the USS Abraham Lincoln (CVN 72) and will be applied to other aircraft carriers in the fleet as they enter their maintenance overhaul periods. Thanks to this seemingly small task completed by Komrower and his team at NCE, there will be a significant decrease in the noise levels, and military personnel on U.S. Navy aircraft carriers will be able to hear loud and clear for years to come. ■

Raising the Titanic

I think we're gonna need a bigger boat

When you ask anyone to name a famous ship, the answer is usually, "the Titanic." Sure, there are other contenders depending on what part of the world you come from, but none left their mark on the wider public's consciousness - or indeed continues to hold it - some 105 years since she sunk. In conversation with some colleagues, the question was posed, "I wonder if anyone's ever looked into simulating the Titanic?"

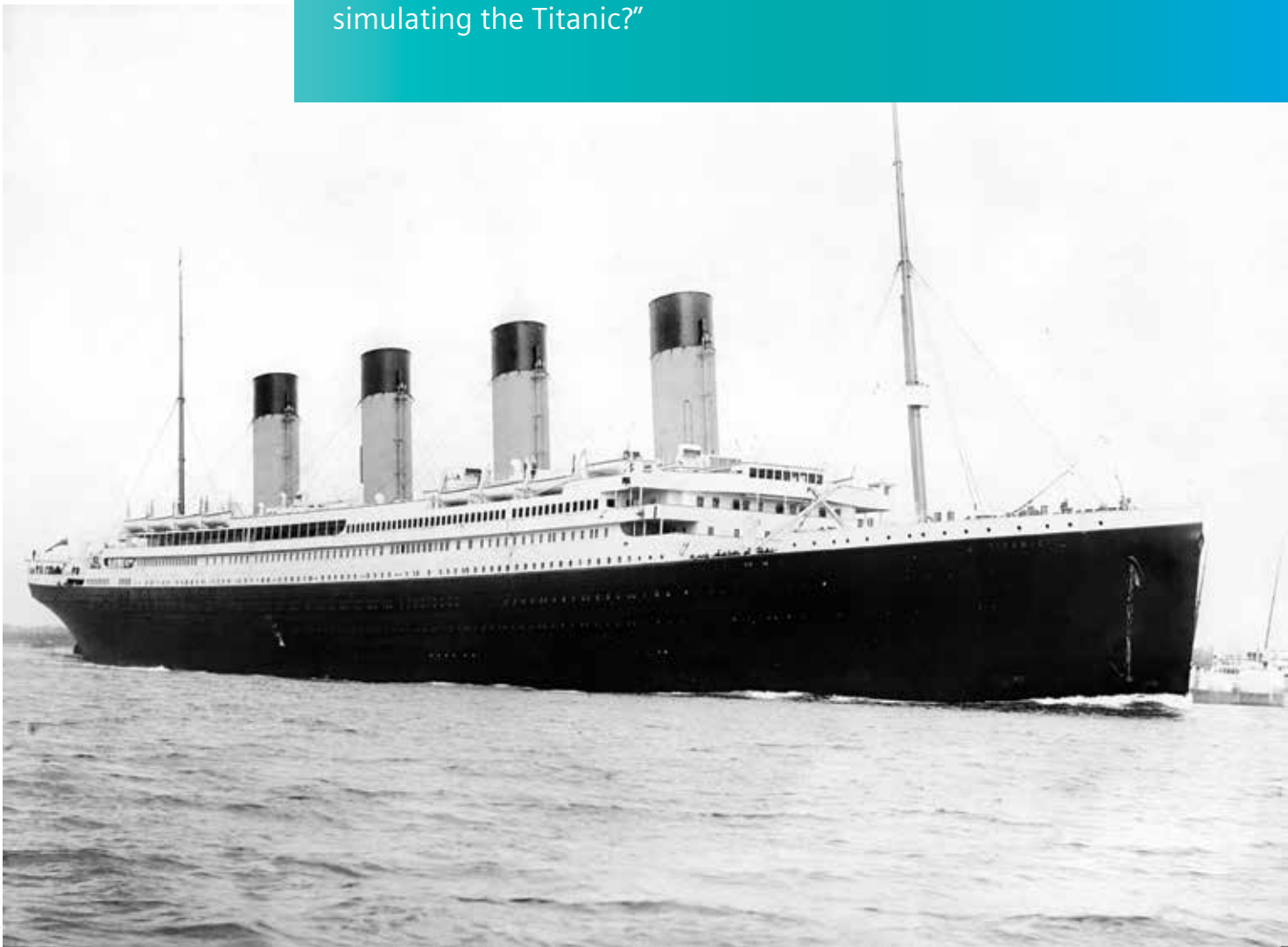

Wikipedia / F.G.O. Stuart (1843-1923)

There are computer animations, but this is not simulation. From a brief scan of the Internet, it seemed this perhaps wasn't the case. There have been quite a few attempts at hand calculations to work out the physics involved, and plenty of debate about the precise nature of what happened with the propeller cavitation or the rudder being too small. But with the current set of computational tools available to engineers these days, specifically computational fluid dynamics (CFD), I thought it would be interesting to look back on the most famous ship of all time through the lens of STAR-CCM+ software. What I learned was not exactly what I was expecting, but more on that later.

So where to start creating a digital twin of the Royal Mail Ship (RMS) Titanic? Thankfully, there are plenty of drawings of the Titanic. Recreating a 3D model in computer-aided design (CAD) is a luxury that we almost take for granted in 2017. (Some 100 years ago, engineers, designers and draftsmen would have loved to have had all this input.) So obtaining a replica of the Titanic is straightforward enough. The first step in getting the Titanic to sail for the first time in 105 years (albeit digitally) is to set up a simple sink-and-trim simulation of the hull and rudder at a 10-meter (m)

draft (the height of the waterline is from the base of the keel) at 22.5 knots, the approximate speed she was last sailing. This way STAR-CCM+ can be used to calculate the precise way the fluid forces acting on the Titanic from the water passing around it made her change how she behaved in the ocean at that speed by modeling the dynamic fluid body interaction (DFBI). This will provide us with some initial information on the amount of thrust required by the propellers to overcome the resistance of the hull in the water and the shape of the wave pattern around the Titanic.

The wave generated by the Titanic passing through still ocean is something that has not been seen for well over a century. However, thanks to the STAR-CCM+ estimated hull performance (EHP) toolset, we are now able to get an idea of the bow and stern waves and the ripple effect these caused (as shown in figure 1). This simulation also gives us an idea of the drag force (approximately 2,600,000 Newton), which would have to be balanced by the three propellers at the rear.

Although section views of the Titanic's structure are available, the sections of the propeller design are less so. This required a few days of forensic engineering based on a limited number

RMS Titanic specifications

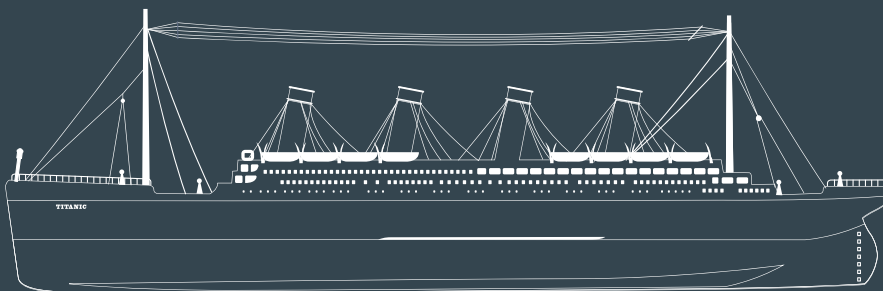

Class & type:	Olympic-class ocean liner
Tonnage:	46,328 GRT
Displacement:	52,310 tons
Length:	882 ft 9 in (269.1 m)
Beam:	92 ft 6 in (28.2 m)
Height:	175 ft (53.3 m)
Draught:	34 ft 7 in (10.5 m)
Depth:	64 ft 6 in (19.7 m)
Decks:	9 (A–G)

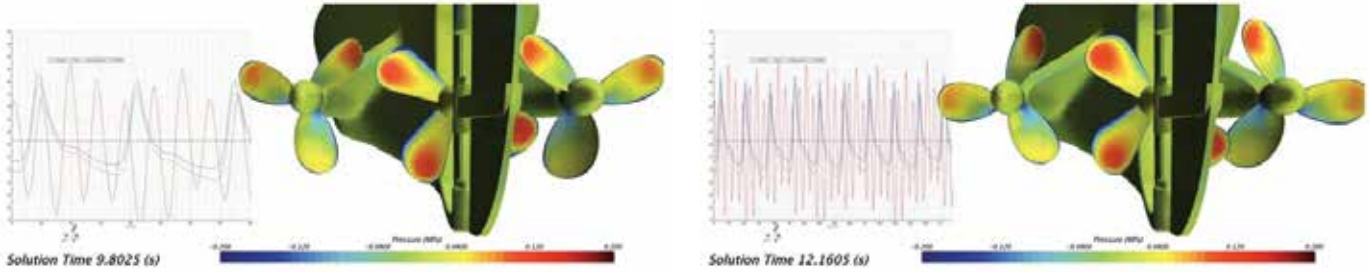

The Titanic’s propellers looking forward from the stern as the ship was going ahead, with outward (contra-rotating) rotating wing propellers and a right-handed central one.

of photographs of the original propellers (see figure 2) and getting these into 3D CAD, testing them at several different revolutions-per-minute (RPM) and then reconfiguring them to get the three propellers to each generate the right amount of thrust to balance the previously calculated drag. With what limited information there was on operating RPM, I eventually got the CFD model to balance with 60 RPM for each of the three bladed wing propellers and 160 RPM for the four-bladed central propeller, and ended up being pretty close to some information I found!

As this infographic shows, there is a passing frequency for each blade as it either passes the wings of the outer propellers, or the keel for the central propeller. This would cause spikes in the thrust, which would also contribute to significant noise, but probably only for the third-class passengers.

So by joining these two simulations together – the hull and rudder as well as the propellers and the operating RPM – we can set up a full model in STAR-CCM+ in one of two ways. One way is the complete model with the correct CAD of the propellers rotating, which is precise but computationally intensive. Another way is using the propeller models in an open-water test to generate performance curve data so that a virtual disc approach will generate the relevant source terms in the propeller region to rotate the water and provide the same thrust.

Either will act as a further refinement of the full ship’s hydrodynamic performance as the effects of the combined hull and propeller will change the behavior of each. We will use the first option. In order to gain initial insight and assist in the debate about the maneuver around the iceberg, which ultimately ruptured enough of

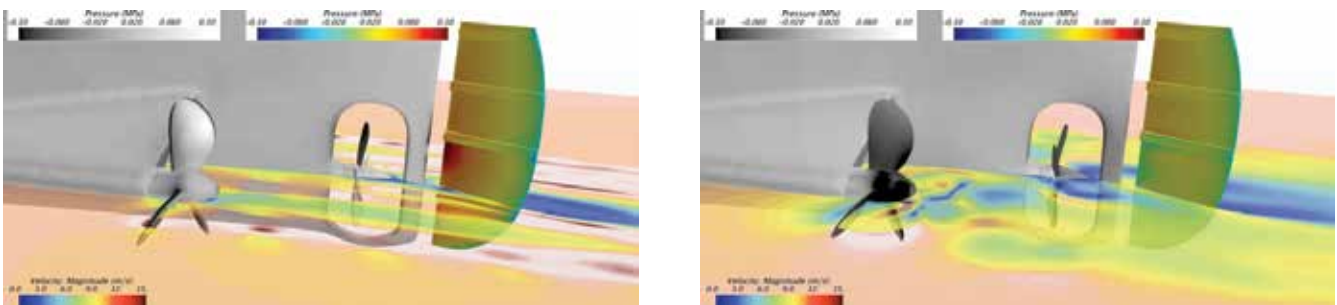

(Left) Full ahead and (right) 50 percent in reverse, both with rudder at 35 degrees.

Image source Shutterstock

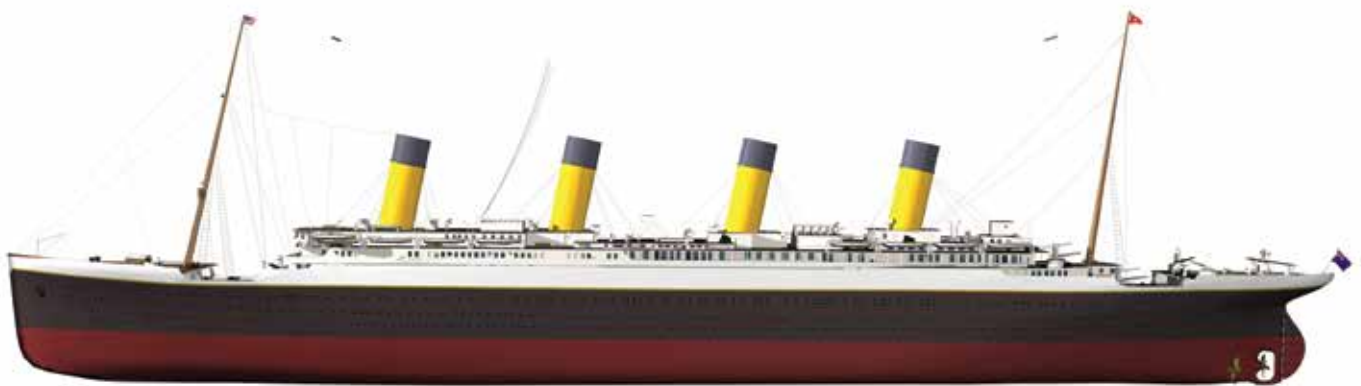

Operated by the White Star Line, the RMS Titanic sank on April 15, 1912 when it collided with an iceberg on its maiden voyage. It was the largest ship afloat at its time.

the side of the Titanic's hull to sink her, it was relatively easy to use the standalone propeller model and rotate the rudder 35 degrees, the approximate angle at which it was steered, since both 30 degrees and 40 degrees are mentioned in past accounts. The propellers are running at full RPM for 22.5 knots and then reversed (at 50 percent of the 22.5 knots ahead RPM). The resulting low pressure behind the propellers as shown in figure 3 reduces the amount of side force the rudder can generate by 30 percent: the deep dark red pressure contour on the rudder gives way to mostly yellow. The velocity plane of the sea acting through the propeller is very slow (dark blue) when the propellers are reversed and the pressure on the downstream side of the propeller is <-0.1 MPa (almost black on the separate hull and propeller scalar contour). Although cavitation is not modeled here, it's doubtful that even with a larger rudder the Titanic would have been able to steer far enough away from the iceberg that claimed her.

So some initial results show how the Titanic is able to digitally sail once more and hint at the potential hydrodynamic

issues with the rudder, which I hope to address in the future. But what of my earlier statement about the things I learned that I wasn't expecting? These were more philosophical issues, such as in order to look to the future, sometimes it's worth looking to the past to appreciate your progress.

Currently, we stand at the dawn of Industry 4.0, and in my study of an iconic ship built at the end of the first industrial revolution, it's clear that it's never been faster or easier to design something. My two-day propeller design would be several orders of magnitude faster than it took the designers of the Titanic.

It would be complacent to ignore past technological advances, which risk being consumed by the passing of time much like the Atlantic Ocean consumed the Titanic, simply because it wasn't swathed in carbon fiber. The one constant in all of this is nature, which we can use CFD to solve. Forging ahead, we have to count ourselves fortunate to be in a time of not only faster engineering, but given the right toolset, more accessible engineering. ■

This article was originally published on the MDX blog.

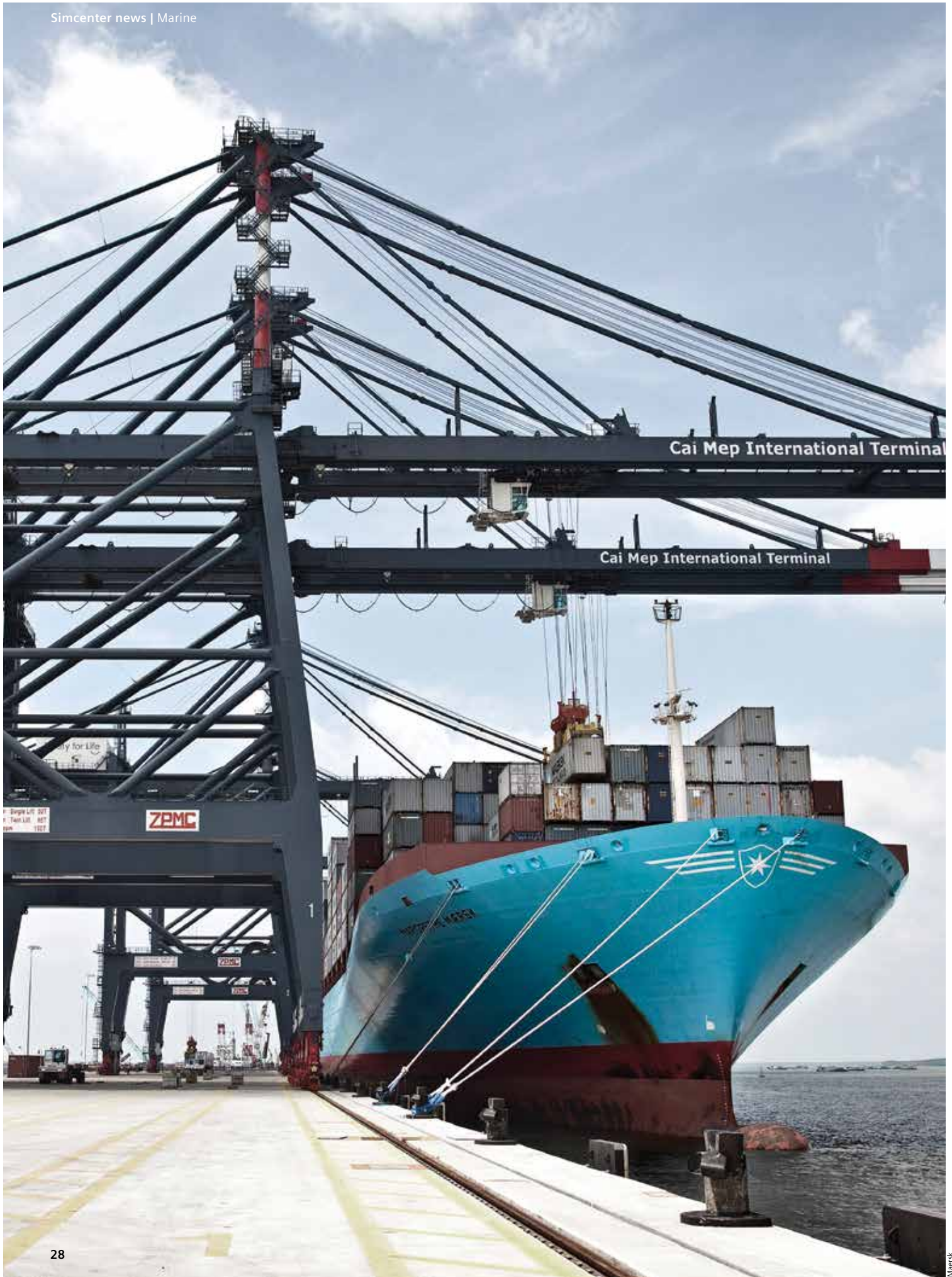

Fueling the Future

Simcenter solution LMS Amesim helps Man Diesel & Turbo simulate gas and liquid fuel injection systems

Shipping's economic and environmental challenges

Following a recent global slowdown in international trade, the volume of goods transported by merchant ships decreased. To remain competitive, maritime logistics companies are limiting ship speed to minimize fuel consumption, which represents 90 percent of the sailing costs for a ship owner and may reach 200 tons per 24 hours for the largest vessels.

To support the slower speeds and meet stringent emission regulations (such as the Tier III nitrogen oxide emissions standard starting in 2016), the shipbuilding industry has started investigating the use of alternative fuels for two-stroke engines. Liquefied natural gas (LNG), methanol, ethanol or liquefied petroleum gas (LPG) may provide a sustainable alternative to heavy fuel oil (HFO), but due to their specific properties such as vapor pressure, temperature, flash point and corrosion, they require different fuel injection systems.

MAN Diesel & Turbo, part of the Power Engineering Business Area of MAN SE, specializes in the development of two-stroke engines for marine applications. Its low-speed product line includes a wide range of marine diesel, biofuel, heavy fuel oil and dual-fuel gas engines, with piston diameters from 26 to 98 centimeters (10 to 39 inches).

Engine testing is prohibitively expensive

With fuel-oil-only, mixed-gas and minimum-oil operating modes, dual-fuel engines offer ship owners great flexibility. Modifying an engine's fuel system to operate on gas rather than HFO requires changing the injection valves, using

double-wall pipes in the gas supply line to prevent the escape of gas, and adding a ventilation system in the space between the outer and inner pipe walls to ensure that any leak is immediately detected by sensors.

Developing new fuel systems using an approach exclusively based on testing is cost prohibitive. "The fuel required for one hour of engine testing costs us approximately \$10,000, and some tests last several days," says Mikkel Thamsborg, research and development (R&D) project manager in the R&D Injection and Hydraulics Department at MAN Diesel & Turbo.

To minimize the need for physical testing, the company uses a model-based systems engineering (MBSE) approach in the design of new fuel injection systems. Previously, this involved an in-house program that was based on Fortran and tailored to the design of traditional HFO engines.

During the development of the new gas-based fuel systems, MAN Diesel & Turbo replaced the Fortran program with LMS Imagine.Lab Amesim software from product lifecycle management (PLM) specialist Siemens PLM Software. LMS Amesim was chosen for its ability to simulate the behavior of both gas and liquid fuel injection systems. MAN Diesel & Turbo also uses the LMS Imagine.Lab™ software Fuel Injection and Valvetrain and LMS Imagine.Lab Pneumatic solutions.

Accelerating the development process

Using standard LMS Amesim features such as supercomponents and submodels, MAN Turbo & Diesel

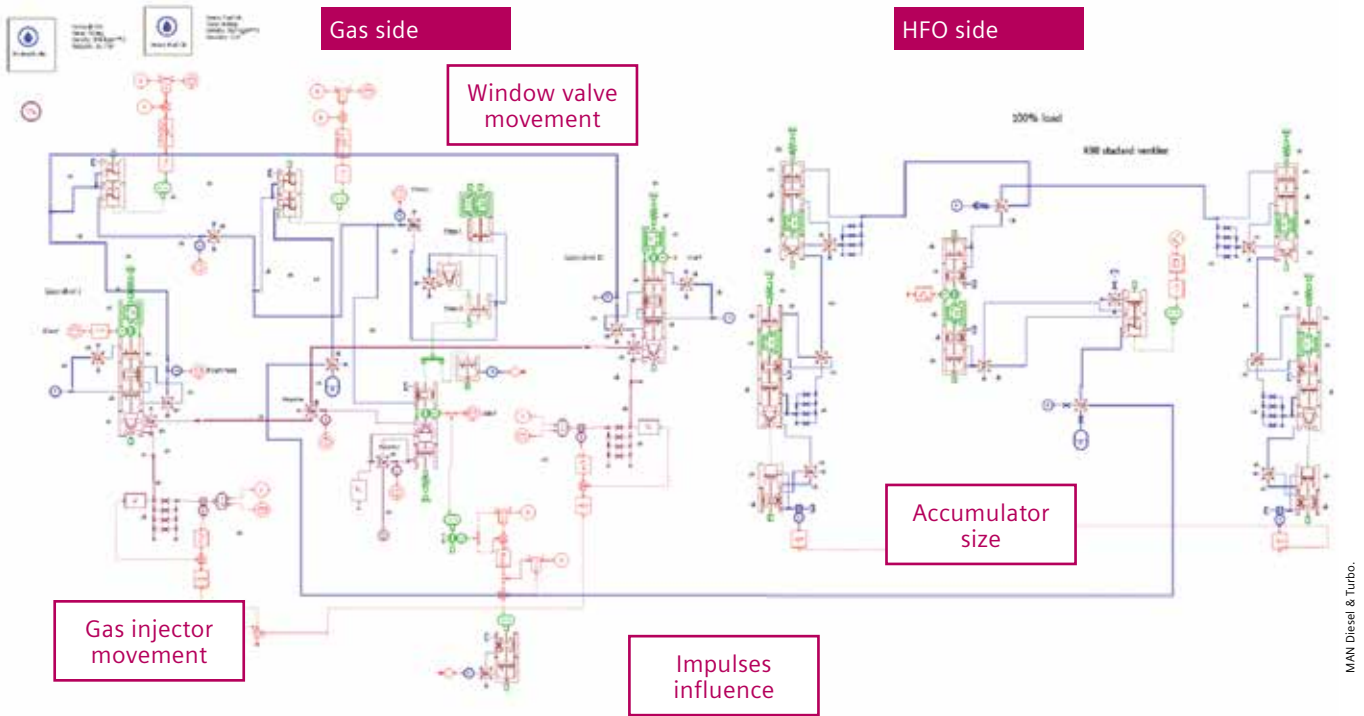

Model created using LMS Amesim, including gas and HFO injection systems.

engineers create libraries of the company’s fuel injector models, including different configurations for each model. Each injector model is then scaled to fit different applications. The software allows for the modeling of any kind of injector technology and the company has created injector models that represent many different technologies.

“When developing a gas injection engine, we have to make a lot of changes,” says Mads Weise Ravn, a research engineer in charge of the design of new types of engines at MAN Diesel & Turbo. “LMS Amesim allows us to implement modifications much faster by using its off-the-shelf components and easily changing their parameters. This allows us to significantly reduce modeling time when designing new injection systems compared to our in-house program.”

During the development of the dual-fuel engine, design engineers used LMS Amesim to determine the size of the shared accumulator (part of the hydraulic actuation system) for the gas and HFO systems, and to determine whether any hydraulic impulses would internally influence the two systems. The software was also used to optimize the opening and closing time of gas injectors, which have a major influence on combustion performance and fuel efficiency.

Huge time savings for environmentally friendly engines

“Using LMS Amesim, development time has been reduced by a factor of five,” says Thamsborg. Another benefit of LMS Amesim is that it is easier to use for new engineers. “To work with our in-house code, it is necessary to be an expert in hydraulics mathematics and programming. Using LMS Amesim the training process for new colleagues is much simpler,” Thamsborg adds.

The dual-fuel engines design by MAN Diesel & Turbo using LMS Amesim produce significantly lower emissions, enabling the company to maintain its position at the forefront of innovation. Compared to traditional HFO operation, these engines reduce carbon dioxide (CO₂), nitrogen oxide (NO_x) and particulate matter emissions by more than 20 percent and sulfur oxides by more than 90 percent.

“MAN Diesel & Turbo has a long history of close collaboration with Siemens PLM Software,” says Ravn. “We are very satisfied with the performance of LMS Amesim. The next step could be the implementation of LMS Imagine.Lab Sysdm software to optimize management of the models we have built with LMS Amesim.” ■

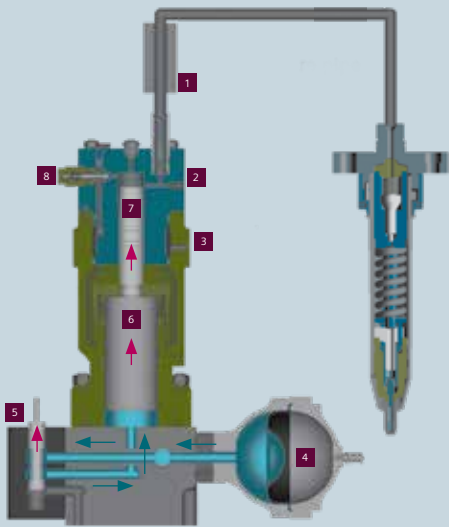

Traditional fuel injection system

- 1 High pressure pipe
- 2 Fuel pump
- 3 Fuel oil inlet
- 4 Membrane accumulator
- 5 FIVA proportional valve
- 6 Hydraulic piston
- 7 Fuel pump plunger
- 8 Suction valve

Traditional fuel injection system of a two-stroke engine; components of the hydraulic actuation system moving the fuel pump plunger.

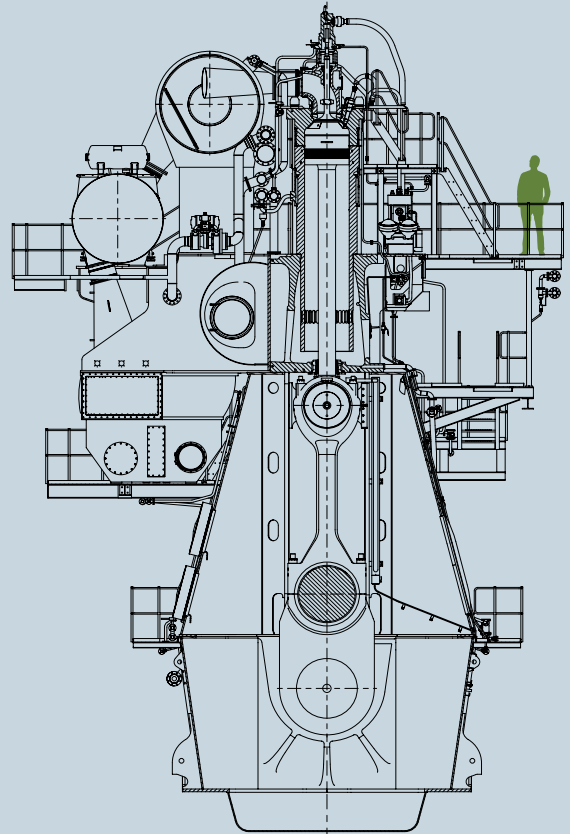

Two-stroke diesel engines are very tall, which enables high-torque performance without any gearbox. Connecting the engine directly to the propeller shaft allows design specialists to achieve 50 percent mechanical efficiency.

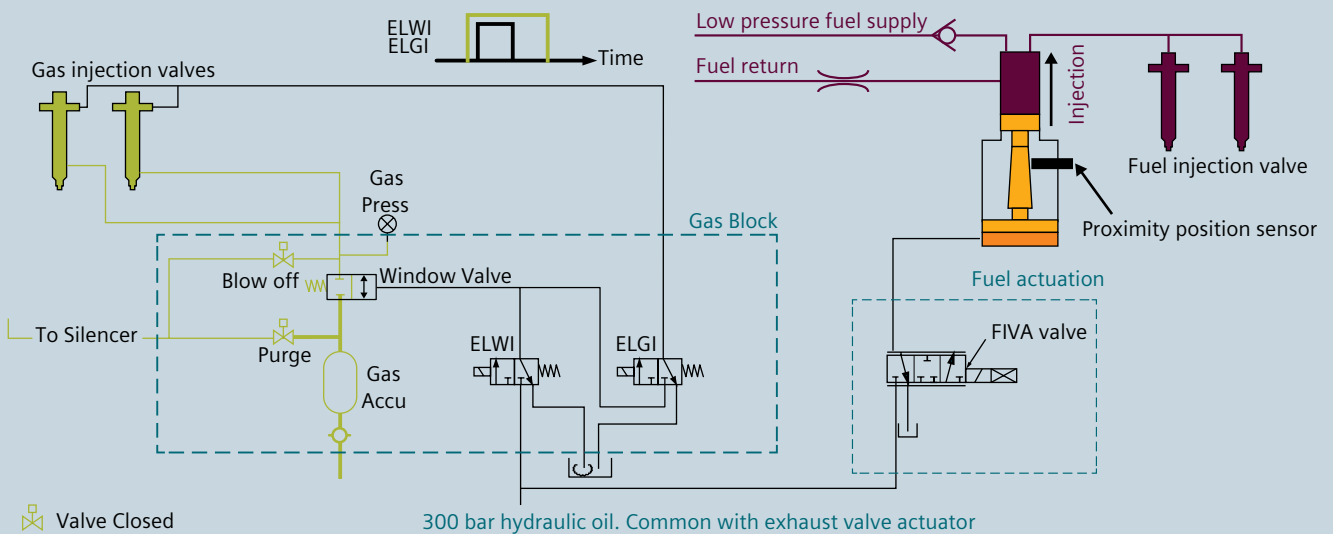

ME-GI injection system for 50 bore and smaller

Source MAN Diesel & Turbo

A marvel of aerodynamic engineering

For almost three years, Siemens' product lifecycle management (PLM) software business has been helping Land Rover BAR to design, evaluate, verify and produce Britain's America's Cup Class (ACC) catamaran on time and on budget.

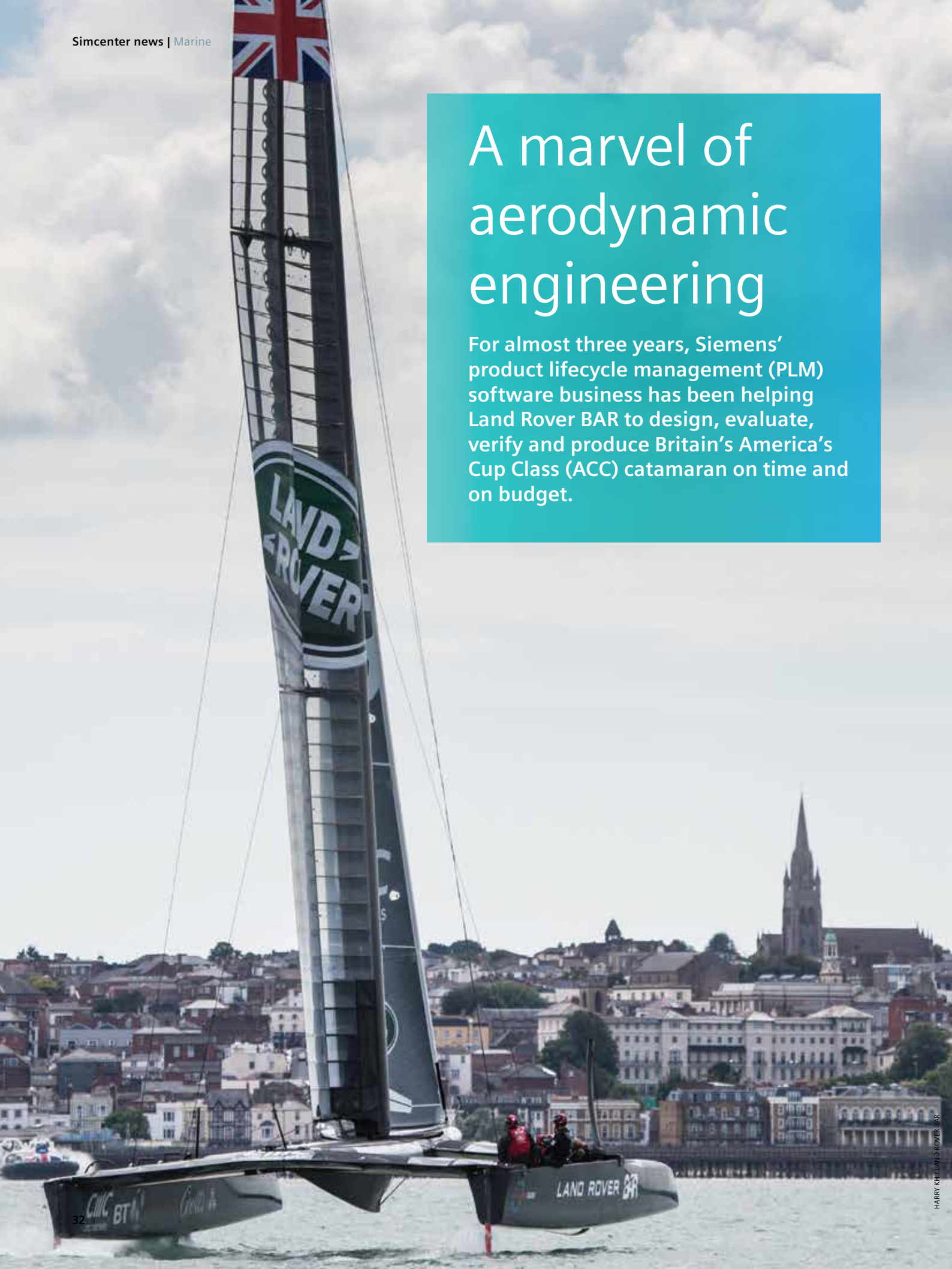



HARRY KIT / LAND ROVER BAR

Over 85,000 hours of design and build have resulted in a 15-meter boat that includes 1,200 meters of electronic and electrical cabling connecting 190 sensors and four video cameras. Working with Siemens, the team successfully managed the ambitious schedule using an integrated software environment for product lifecycle development that enabled multiple disciplines to work together seamlessly. The result is literally a flying super catamaran (christened “Rita”) with top speeds over 50 miles-per-hour (MPH). Although Rita didn’t take home the Cup, the flying catamaran and its crew gave a performance to remember.

“Siemens’ software technology has enabled us to simulate, analyze and test design solutions throughout the design and build process,” says Andy Claughton, chief technology officer (CTO) of Land Rover BAR. “Using this software has saved time and allowed us to continue to make improvements up to the competition, where we hoped to bring the Cup home to Britain for the first time in race history.”

Land Rover BAR chose solutions from Siemens PLM Software to adopt an integrated virtual environment for digital modeling and simulation. Software products included NX software for product design, Teamcenter software for data management, the Fibersim™ portfolio of software for composites engineering and the Simcenter software portfolio, including Femap™ software and STAR CCM+ software for engineering analysis and computational fluid dynamics (CFD) analysis.

To effectively engineer a highly competitive and innovative racing boat, continuous improvements must be made to the design during development. PLM solutions from Siemens allow Land Rover BAR to create a digital twin of their boat for rapid evaluation and collaboration. NX, used for digital design and engineering analysis, enables rapid modifications to boat design during the development phase and automatic revisions to the digital model based on virtual simulations. By discussing technical changes with the team on the basis of 3D models representing the digital twin, the design is improved more quickly and at less cost. Using Teamcenter as the digital thread across engineering processes allows the team to work with a single source of the latest product data. Teamcenter is used to manage the complete product definition, revisions and the process of introducing changes. It maximizes the power of product and process knowledge to drive productivity and innovation.

“We are proud of our partnership with Land Rover BAR and were excited to see Rita compete in the 35th America’s Cup,” says Tony Hemmelgarn, president and chief executive officer (CEO) of Siemens PLM Software. “To be successful, the race requires teams to integrate seamlessly during development and design and continue through testing. Our integrated industry solutions, combined with the expertise of the entire design and racing team from Land Rover BAR and partners, has resulted in an impressive world-class racing boat for the British team.” ■

The Secret is CFD

Cape Horn Engineering talks about the role simulation software has played in the competitive field of yacht racing

Cape Horn Engineering was founded in 2007 with the vision of using the best available CFD tools for the design of racing yachts. They have been involved in several America's Cup campaigns and their designs have dominated the Around-the-World Volvo Ocean Race for almost a decade, winning three times in a row with ABN Amro (2005/06), the Ericsson Racing Team (2008/09) and the Groupama Sailing Team (2011/12). Cape Horn Engineering is proud to be part of the design team at Land Rover BAR, the British challenger for the 35th America's Cup in Bermuda in 2017.

With the company in its second incarnation as a partnership between founder Dr. Rodrigo Azcueta and naval architect and marine engineer Matteo Ledri, the team has successfully expanded its range of activities to commercial ships, large super yachts and more recently the renewable energy market. We spoke with Azcueta, Ledri and Elisabeth McLean, a CFD expert, about the role simulation software has played in the competitive field of yacht racing, and how it has helped them discover better designs. Faster.

Tell us about yourself. What attracted you to CFD?

Azcqueta: I come from a family with a very strong maritime background. Both my father and grandfather were navy officers. I started sailing at a young age and discovered a passion for racing boats. For that reason, I studied naval architecture and marine engineering, first in Argentina and then in Hamburg, Germany, where I also completed a PhD specializing in CFD applied to yachts and ships. As a student, while working in towing tanks, I realized that computers and simulations were going to take over from the physical models, so I decided to focus on the newest simulation methods. Computer simulations for ships had existed for a long time with simplified theories, but the new methods based on Reynolds Average Navier Stokes (RANS) CFD opened up a whole range of new possibilities with far more precise flow analysis than had been possible until then. This was more than 15 years ago, and I was in the right place at the right time: I found myself pioneering the field of RANS simulations with free surface for floating bodies; for example, simulations of boats or ships free to move on the surface of the

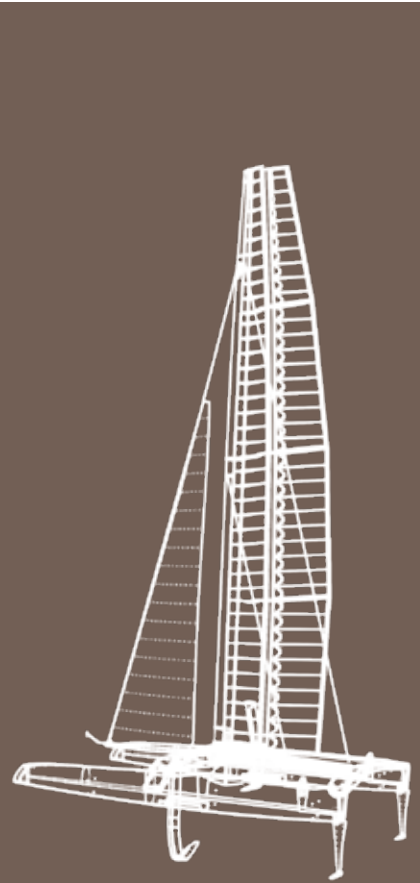

- Width: 8.48m
- Length: 15m
- Wing height: 23.5m
- Wing area: 103 sqm
- Number of crew: 6
- Total crew weight : 525 kg
- Sustained power delivered by crew: 1200 w
- Top speed
3x speed of wind: 60 mph
- Sailing weight: 2,400 kg
- Construction time: 35,000 hrs
- Length of electronic and electrical cabling: 1,200m
- Number of video cameras: 4
- Number of sensors: 190
- Total amount of data delivered per session: 16Gb

Source: Land Rover BAR



Siemens PLM

ocean under the effect of external forces like wind or waves. In 2002, I felt that the timing was perfect to apply those innovative methods for the design of high-performance yachts, such as those used in the America's Cup, and fulfill my dream of working for a team. I presented my work in Auckland, New Zealand at a conference in the context of the America's Cup and got the attention of several yacht designers who offered me the opportunity to work on their teams. This was the beginning of my current profession.

Ledri: Being a sailor since I was a kid, I think it was natural for me to study naval architecture and be attracted to fluid dynamics. I love studying and understanding how a boat interacts with air and water. CFD allows this, and does it much better than a towing tank or a wind tunnel. You can predict the forces acting on the system and also visualize wave patterns, streamlines and pressure distributions on all the components. And if you have a crazy idea, you can test it quickly without building a physical model. Cape Horn Engineering is a company doing exactly all of that at the highest level. I had studied Rodrigo's publications at university and now I am proud to be a partner with him at the company.

McLean: Flow dynamics is such an interesting field to get involved with. The marine environment is affected by engineering decisions at all levels – a well-positioned exhaust duct will not create any discomfort for the guests on a motor yacht and designing the fastest yacht will win you races. CFD is a great tool to understand and predict marine performance because it gives you both quantifying data such as drag on the hull, and visual data to further understand the flow behavior. Cape Horn Engineering is a company with a wealth of experience in designing winning race yachts, and since I have joined the team I always have something interesting to work on at my desk.

What kind of problems are you trying to solve with STAR-CCM+?

McLean: There are three main areas we work on: Sailing yachts to increase the yacht performance and help our clients win races, shipping to cut fuel cost or to improve comfort on luxury motor yachts, and renewable energy to harvest most of the wind power.

Do you have a few specific examples you could tell us about?

Ledri: In the design of an America's Cup racing catamaran, there are a lot of components involved: hydrofoil simulations with motions and free surface, aerodynamics on wing, sail and all the platform fairings, fluid-structure interaction, cavitation modeling, laminar/turbulent transition, and many more. STAR-CCM+ allows us to do all of the above with the same tool, streamlining the workflow with powerful automation capabilities.

McLean: For the daggerboards the foils, the fluid mechanics of lift, are paramount. Sailboats are generally far more complex than an airplane, which is immersed in only one fluid, air, while the foils on the boats are piercing through the free surface between air and water. The design aspect of lifting surfaces within the presence of a free surface is still a new field of fluid mechanics. Furthermore, America's Cup boats have a rigid wing with a flap element instead of a traditional fabric sail. Adjusting the angle between the two elements of the wing changes the deflection of the airflow for more force to be generated. We are aiming to design the most efficient wing while giving the wing trimmer as much control as possible.

How did you end up choosing STAR-CCM+ as your CFD solution?

Azcueta: We have had a long association. It started 20 years ago when I was at the University of Hamburg and started using COMET, one of the predecessors of STAR-CCM+. I was sharing the same offices as the developers of that code and had to write my own routines in Fortran to make the solver do what I wanted it to do. Initially, we could not model the interface between water and air, the so-called free surface. But then, a volume of fluid method was implemented in COMET and I was the beta tester, and for sure the first researcher to use it for yachts. In the following years COMET became the tool of preference for solving ship flows with free surface and started to get more and more users worldwide. After a long time using COMET, I switched to using STAR-CCM+ and haven't stopped using it since then. In my view, STAR-CCM+ is the best code on the market, especially for applications involving ships and free surface flows.



Elisabeth McLean, CFD expert.



Matteo Ledri, naval architect and marine engineer.



Dr. Rodrigo Azcueta, founder.

Ledri: The STAR-CCM+ DFBI solver together with overset grid technology is perfect to simulate equilibrium conditions on a flying boat in which large motions are involved. Everything can also be automated, making it easy to perform parametric studies.

The Java application programming interface (API) is extensive and well documented and the support is quick and helpful. When we joined Land Rover BAR at the beginning of 2014, we knew that STAR-CCM+ would be our first choice. But it's always good to keep an eye on other tools in order to find the best one for the job, so we completed an extensive evaluation of different products. At the end of the day, we had a clear winner with the efficiency and flexibility of STAR-CCM+, the new optimization package Optimate and outstanding technical support.

What impact has CFD had on the marine industry? Why do you think the industry is so reluctant to move away from model testing?

Azcueta: In my view, the marine industry can benefit more than any other industry from CFD simulations. This is due to the size of the ships, and the fact that they move at the interface between water and air. Planes are big as well, but they fly in one medium only. Cars are small and can fit inside a wind tunnel. But ships are huge and float on water, and because of the physics involved, it means that the force similarities between the model at scale and the real ship cannot be achieved in a towing tank. That's why a test in a towing tank is very tricky and is based on a lot of assumptions, empirical formulations and experience. Today with CFD, this problem is eliminated since we can model the ship at full scale. The shortcomings of towing tanks are more evident in the case of sailing yachts. Yachts create a large lateral force compared to the

resistance. In addition, yachts sail in a wide variety of conditions, drifting sideways, heeling over, pitching and at many different speeds. For these reasons, testing sailing yachts in towing tanks is much more difficult than testing motor ships. I and a few others recognized this situation many years ago and campaigned for using simulations only in the design of yachts. Nowadays, I don't think there is any racing team that would use towing tanks instead of CFD for the bulk of their design. In the case of commercial ships, the industry is very conservative. And since they deal with products that are hugely expensive to build and operate, they prefer to rely on the experience of towing tanks for their final designs to make sure that they meet their clients' requirements. The main concern with CFD is that it has become very easy to produce some sort of results and nice flow visualizations. While good towing tanks with enough experience to predict ship performance within a few percent error do not exist in a large number, maybe 20 worldwide, new so-called CFD experts arise every day and claim to predict performance within 1 percent precision. For this reason, it is crucial to choose a CFD service provider carefully.

McLean: Another advantage of CFD compared to the towing tank is that CFD can be used to investigate the forces on each component of the ship or yacht; the hull, appendages, sails and propellers. It can also take into account complex physical phenomena like cavitation, the transition of laminar to turbulent flow, spray and wave of foils piercing the free surface, the deformations or fluid-structure interaction, flow separation, stall and reattachment, and the dynamic behavior of the boat in the environment.



What kind of problems are still challenging for CFD?

Azcueta: One of the main challenges we have been facing all these years is what we call numerical ventilation, especially for planing hulls. For instance, in a motor or sailing boat, the free surface gets smeared and unphysical ventilation (air bubbles) is observed below the hull. This is a typical problem of the volume of fluid method. When numerical ventilation occurs, not only is the friction resistance not well captured, but also the stagnation pressure at the bow cannot build up and the bow wave is smaller than it should be. The resulting forces can be in error by as much as 50 percent. After dealing for quite a long time with this difficulty, we now have found a solution that works and are confident that our simulations are quite accurate.

Considering that all racing teams use CFD, what is the deciding factor in terms of who wins?

Ledri: We are working in a highly competitive environment, pushing the envelope in all areas of the design, so we need to provide a quick and reliable CFD solution for the production of performance data and, at the same time, work on R&D to develop tools and techniques that will be key to improve the design in the future. The key part is finding the right balance between producing results and improving

them through R&D, and between accuracy and speed. It's essential to be accurate enough to drive the design in the right direction, but it's also very important to deliver quick results so more design variations can be tested.

How do you combine your personal experience of sailing with CFD simulations?

McLean: We are experienced sailors and that gives us first-hand knowledge about the product we are designing, and we understand the physics that the yachts are exposed to. CFD enables us to use our experience and understanding to explore a large design space and/or to focus on small details, the sum of which makes for a winning boat.

How is it to work for Land Rover BAR?

Azcueta: Land Rover BAR is a fantastic team made up of great individuals and team players. We at Cape Horn Engineering are really proud of having embarked on this journey with this team.

The whole team is under the same roof here in Portsmouth (United Kingdom) in this spectacular headquarters. Technological advances have always been at the heart of the America's Cup, and here at Land Rover BAR, we have the proper CFD resources in place to explore innovative designs. ■

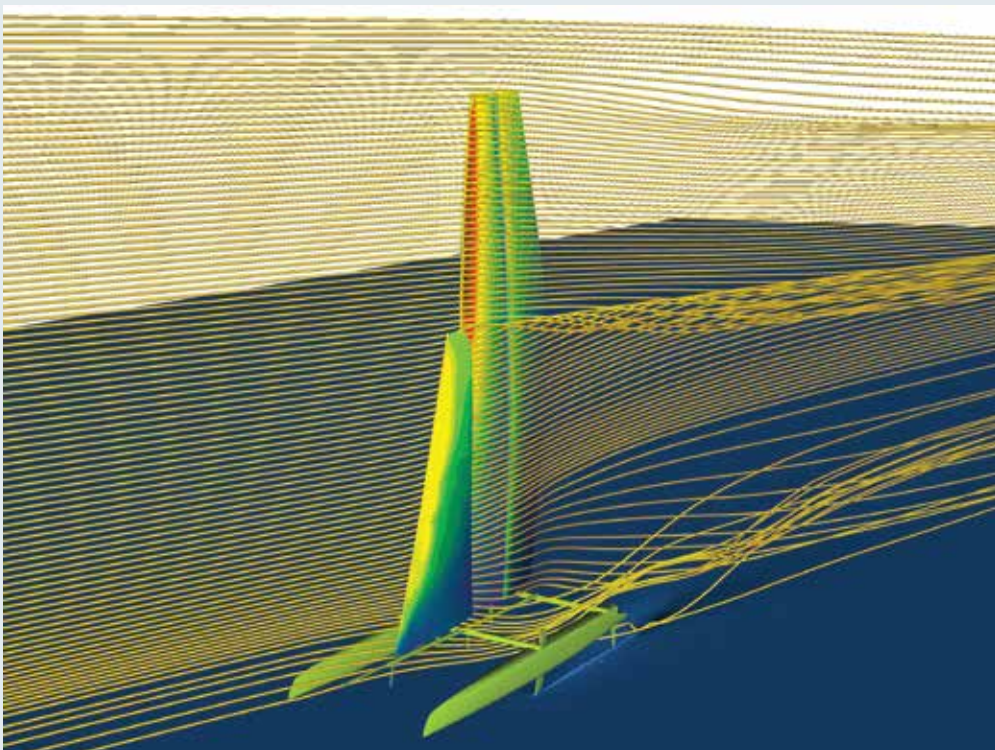

The route to smarter ships

China Classification Society creates new marine engineering software using Simcenter 3D and NX



Image Courtesy: Port of Felixstowe

Founded in 1956, the China Classification Society (CCS) provides classification services to ships, offshore installations and firms that produce related products by furnishing well-accepted technical rules and standards. The CCS also provides statutory surveys, impartial and integral classification, verification, certification and accreditation and other services in accordance with international conventions, regulations and the related rules and regulations of the authorizing flag states or regions. Up until now, the CCS has been authorized by 40 major shipping nations or regions in the world to perform statutory surveys for the ships flying their flags.

In addition to this, the CCS provides services for a range of industries and fields, including shipping, shipbuilding, shipping finance and insurance, marine equipment, ocean resources exploitation, ocean scientific research, industrial supervision, system certification, government policy and rule development, energy saving and emission reduction, risk management and evaluation.

New business opportunities

As part of the CCS mission to build a first-class international classification society with its own technology as a cornerstone, the CCS recently partnered with Siemens PLM Software to develop COMPASS, its next-generation marine engineering computing software system. The new system works in conjunction with Siemens' NX software for 3D

modeling and Simcenter 3D software analysis to deliver highly integrated functionality with powerful ship performance computing, specification computing and structural computing. This avoids the need for repeated entries of large volumes of data during the ship design and drawing review processes. Using the system significantly shortens the design and drawing review cycles and ultimately improves productivity.

The Siemens industry-specific software solution for shipbuilding helps promote standardization, modularization, integration and intelligent management. It leverages unified data standards, modular design and convenient ship-specific CAD parametric modeling capabilities to automatically generate computer-aided engineering (CAE) models for simulation. The models fully meet finite element structural computing requirements, addressing one of the technical challenges the industry has been struggling with for many years.

COMPASS will become an integral part of intelligent ship manufacturing, enabling China's marine industry to realize complete lifecycle digitalization and help customers achieve full lifecycle management from design, drawing review and manufacturing to operation management.

Zhu Kai, CCS vice president, says, "The CCS will launch this new generation system to integrate 3D ship design and

drawing review, aiming to provide China’s marine industry with more advanced, intelligent and efficient services. A 3D-based marine engineering computing software system has long been expected by the shipbuilding industry. We chose NX for its advanced modeling and fully embedded 3D CAE capabilities, powered by Simcenter 3D, in order to leverage its strong capabilities and Siemens’ technical support in design and engineering. CCS will continue to invest in R&D and provide new services and products to boost intelligent manufacturing in China’s marine industry.”

“It’s truly an honor for us to strategically partner with the CCS and promote the digitalization of China’s marine industry together,” says Leo Liang, senior vice president and managing director of Greater China, Siemens PLM Software. “CCS’ leading expertise in the industry combined with Siemens PLM Software platforms and R&D capabilities will help China’s marine industry realize standardized, modularized, integrated and intelligent management throughout the ship lifecycle.”

In addition, many other institutions also participated in this project, such as the China Ship Scientific Research Center, CAD Center of Huazhong University of Science and Technology, China Ship Design & Research Center, CSSC 708 Research Institute and Wuhan University of Technology. ■

» *We chose NX for its advanced modeling and fully embedded 3D CAE capabilities, powered by Simcenter 3D, in order to leverage its strong capabilities and understanding in terms of technical support in design and engineering.*«

Zhu Kai
CCS, Vice President

Container ships

Size of new build container ships through the years

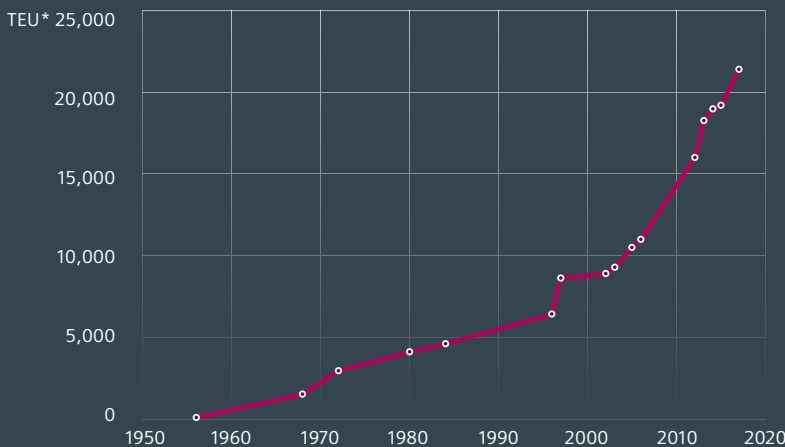

* 20-foot equivalent unit

Container ship fleet in million TEU*

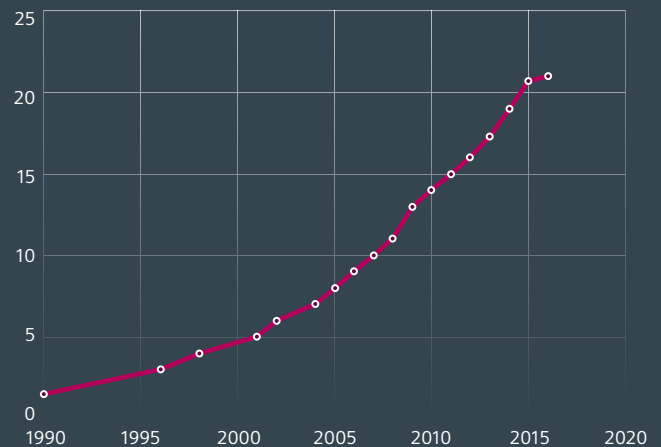

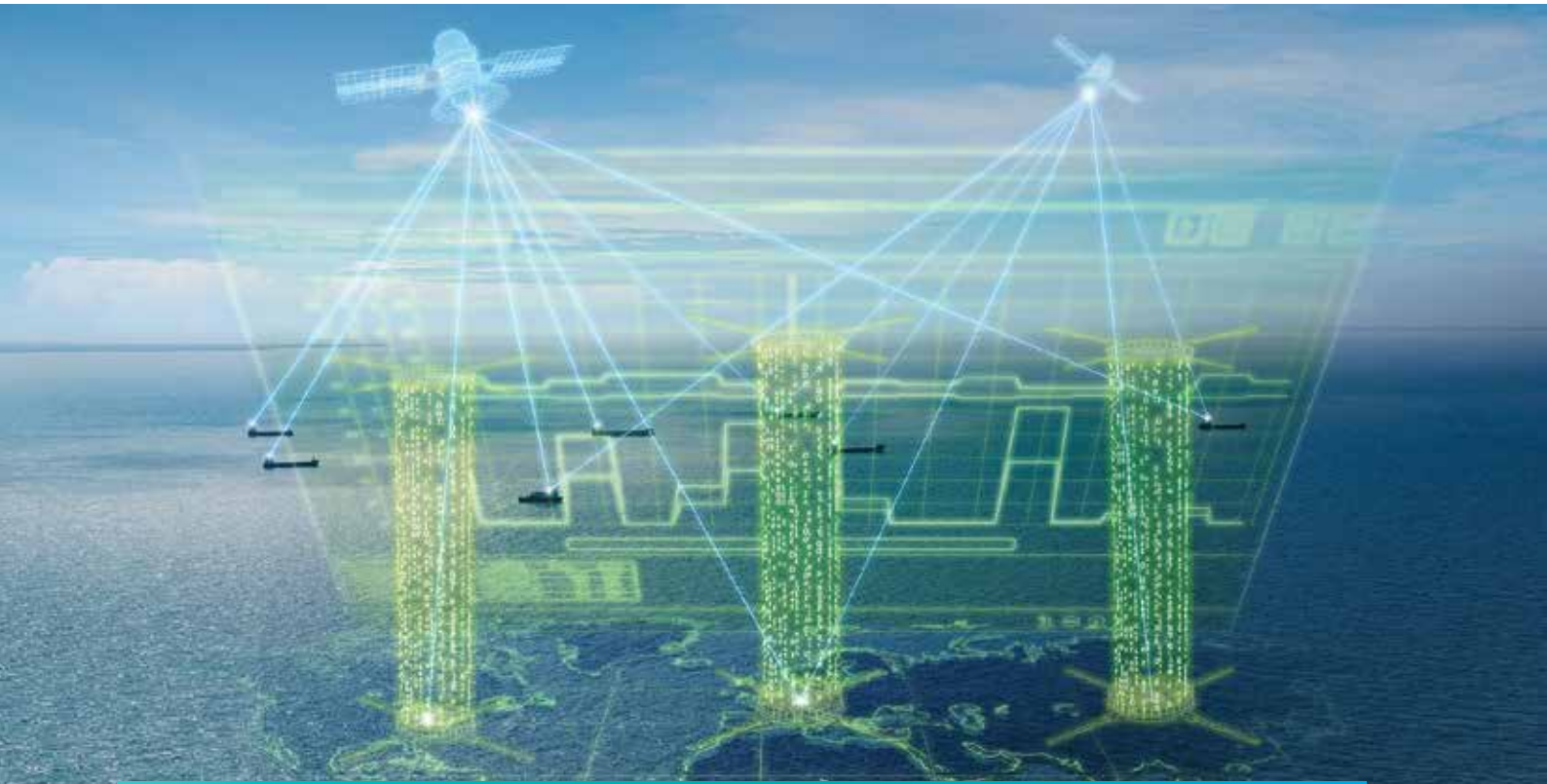

The route to improved efficiency

LMS Imagine.Lab Amesim plays an important diagnostic role in the Siemens SISHIP EcoMAIN operation management system.

In the future, waste heat recovery (WHR) systems will be used increasingly as a measure to improve efficiency on marine vessels. This means the question of reliable and focused fault detection will also become more important. Siemens has adapted to these requirements early on and has developed an innovative simulation-based diagnostic system. The monitoring tool is linked with the SISHIP EcoMAIN operation management system as a software module. Since 2011, it has been used on a container ship with a drive power of 60 megawatts (MW) and is continuously optimized during operation.

Using a simulation-based diagnostic tool for better WHR on vessels

Siemens has developed a diagnostic tool especially for the waste heat recovery systems used on vessels. The tool is not based on the simple comparison of measurement values, but uses simulation to

determine the desired state of the components. Compared with conventional diagnostic approaches, faults can be detected faster and localized more accurately. Furthermore, the software module can be adapted flexibly to different system configurations.

The main challenges

The propulsion systems of modern vessels are increasingly complex and include new systems to reduce consumption, for example, using WHR and emission reductions to fulfill ever-stricter environmental regulations.

With the increasing number of systems, the number of potential sources of failure also grows. Testing the ship's functionality using on-board diagnostics is becoming more important. These supervision and inspection systems are designed to uncover component malfunction during operation, thus increasing system efficiency and reliability.

Integrating diagnostic functions is a real challenge for developers. In shipbuilding, tiny production volumes for system configurations, including one-off manufacturing, are quite normal. Due to the high number of variants, database values containing desired parameters, particularly for the overall system, are generally not available, or are only available to a limited extent. Siemens PLM Software has developed a software tool for on-board diagnostics, specifically for monitoring WHR systems according to the Rankine principle. It is based on the individual evaluation of each component using its characteristic exergy loss. The system calculates the setpoints for each operating point dynamically and individually using complex simulations based on a thermo-economic model. This approach is fundamentally different from concepts used up until now, which merely compared measurement values with stored standard setpoints from a database.

A new concept based on a simulation

The overall tool includes a thermodynamic and a thermo-economic software model, which are linked to each other. First of all, the mass flows, intake and discharge temperatures and negative pressures of the fluid flowing through the relevant components for WHR diagnostics in the overall system are calculated, using thermodynamic simulation. Important input parameters for this are: the machine load (which is used to calculate emissions quality using a characteristic map), as well as the ambient, intake and seawater temperatures. These values are readily available in the drive data system, so there is no need for additional monitoring hardware.

The results of the thermodynamic calculation form the input dataset for the thermo-economic model. This simulation is based on the analysis of the energy state in the fluid. According to the first law of thermodynamics, energy cannot be destroyed, only converted. In contrast, according to the second law of thermodynamics, exergy generally does not remain after a change of state, due to irreversibility. So when a WHR steam cycle is applied to components, in most cases exergy is destroyed. Determining how much exergy is lost in a component can be used to acquire information about its efficiency.

If the actual mass and energy balance of the WHR system is different from the predicted values for the normal state, generally there

is a fault in individual components or an operation anomaly. To determine an erroneous discrepancy, the diagnostic tool compares the simulated actual states for each individual component in the overall system with the desired states. These are calculated in the system application phase using design data. They are stored in the diagnostics block as a characteristic curve. They specify the expected change in the exergy destruction of a component depending on the load. The program uses the current operating conditions to calculate the real exergy loss in the component. The deviation of the current state from the characteristic curve is determined in the form of an indicator. This method can be used to assess whether there is a fault in the relevant component, or if it is functioning normally and the surrounding components are responsible for the operation anomalies.

System specifics

The following elements are incorporated in the current monitoring concept: turbocharger compressor, turbocharger turbine, exhaust gas turbine, steam turbine high-pressure side and steam turbine low-pressure side. Although the database values of conventional diagnostic approaches are only valid for prespecified standardized boundary conditions, the simulation uses real parameters from the ambient and operating conditions. For example, this allows influencers like extreme climatic conditions – such as very low temperatures in the Antarctic, or high water and air temperatures and air humidity in the Caribbean – to be taken into account. The diagnostics use this data to be precise so that deviations from the setpoint can be detected much earlier.

To separate faults due to component defects from system and operation-related fluctuations, an individual threshold value has been introduced for each component: All deviations up to 10 percent from the actual value from the setpoints are categorized as uncritical functional uncertainty. Discrepancies going beyond this are interpreted as a fault state. During operation, a new simulation is run every 30 seconds so the latest value for the actual/target comparison (which takes place once a minute) is always available.

The diagnostic tool was created with LMS Amesim from Siemens PLM Software. It is installed on the ship as a runtime version, enabling components in the entire WHR

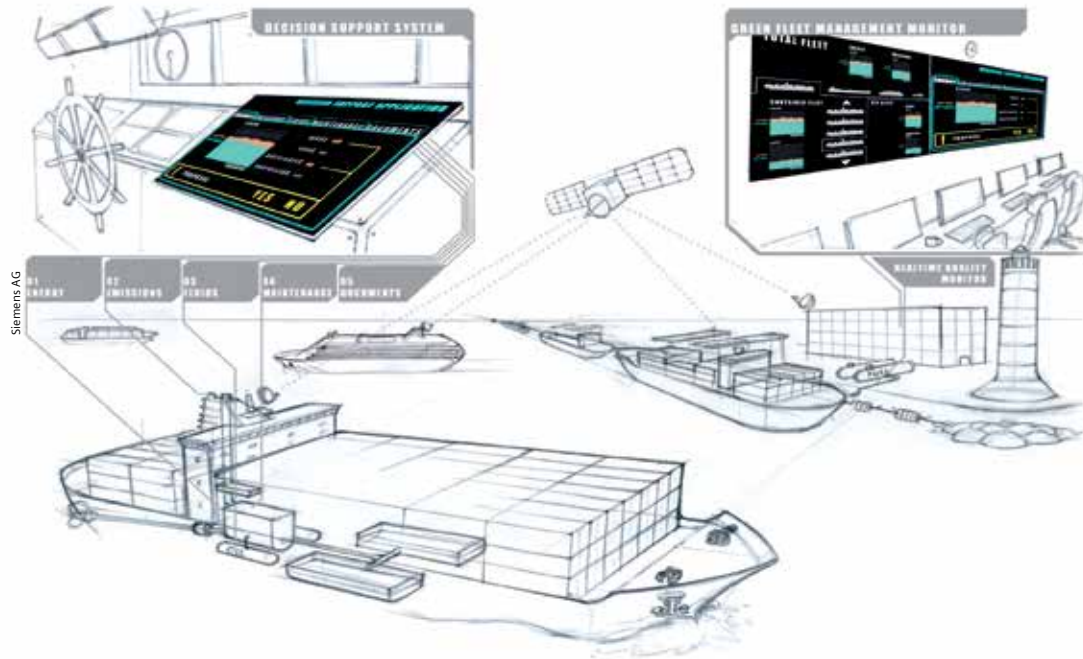

system to be exchanged quickly and easily. This flexible simulation software ensures that the model can be adapted rapidly to new system configurations. This is important because WHR systems generally consist of partial elements from different manufacturers, which are put together individually by the WHR unit developer.

Furthermore, while the ship is being built, the simulation model can be used to design individual WHR unit components by using parameter studies to optimize the efficiency of the overall system. For example, the surface area of the heat exchanger in the exhaust system can be adapted so the exhaust gas temperatures are kept as low as possible, and condensation in the chimney (due to temperatures that are too low) is eliminated.

Clear text information on fault states

If the diagnostic system detects a defective component, it does not change the controls of the WHR system, but instead gives appropriate component-related alarm messages in text form. This way an on-board technician can recognize the cause of the problem without having in-depth knowledge of thermodynamics or the system. Instructions and actions are included in the message, which might range from changing a valve position to repairing or replacing entire components. The instructions for the appropriate way to proceed if a component needs to be repaired, cleaned or replaced can be found in the relevant manufacturer’s guidelines.

An important part of the Siemens SISHIP EcoMain operation management system

The diagnostic tool is incorporated as a software module in the Siemens SISHIP EcoMAIN operation management system. The platform is used to collect and process all the

ship’s functional data, making it quick and easy to view for the crew and the ship owner. This includes, for example, temperatures, rotational speeds, draft and speed, but also external influences, such as weather data and water depth. Thanks to a holistic approach, using SISHIP EcoMAIN enables the greatest possible transparency because it takes all the relevant ship information into account.

The system gives targeted recommendations; for example, for trimming or navigation, which are based on evaluated interactions of the data. This enables operations on board to be organized as efficiently as possible. Energy consumption, emissions, bunkering liquids, maintenance plans, documents and knowledge management and much more can be evaluated and subsequently optimized. The greatest potential of the management system is improved efficiency, environmental compatibility and maintenance cycles.

Using SISHIP EcoMAIN enables you to administer large quantities of data and harmonize file formats. The system is based on the app principle. This means the applications are installed on the server in virtual machines. These are integrated in such a way that all the important information is bundled and centralized and is available to the user in a single interface. SISHIP EcoMAIN is an open platform, which can be implemented using all kinds of applications via interfaces using industrial standards such as Profinet, Profibus, Ethernet, Modbus, NMEA or OPC UA. Software modules can be integrated either by Siemens’ customer team or, alternatively, by other providers.

If a ship operator uses a different operation management system instead of EcoMAIN, the WHR diagnostic tool from Siemens can also be connected to it just as flexibly using script. ■

LMS Imagine.Lab Amesim and the marine industry

The marine shipping industry still has some work to do in regards to fuel consumption and pollution reduction. The International Maritime Organization has set goals to reduce CO₂ and NO_x by 20 percent by 2020 and 50 percent by 2050. LMS Amesim can help shipbuilders build high-performance, eco-friendly powertrain systems by bringing electrification and hybridization into the picture using dedicated solutions available in the software package.

LMS Amesim lets users efficiently evaluate interaction when integrating subsystems, such as the engine, electric generator, power electronics and cooling systems. This can occur during the entire design process from multi-system architecture creation to systems and component design, system integration and control strategy validation. Even during early stages of the development cycle, users can analyze the model results to reach the ideal architecture for minimum fuel consumption and NO_x emissions.

By building a virtually integrated ship model in LMS Amesim, users can check what impact their system architecture choices have on the entire vessel. Using LMS Amesim early in the conceptual process helps naval architects and other marine experts make the right decision when it comes to the vessel's energy balance. And this is a win-win for the marine shipping industry. ■

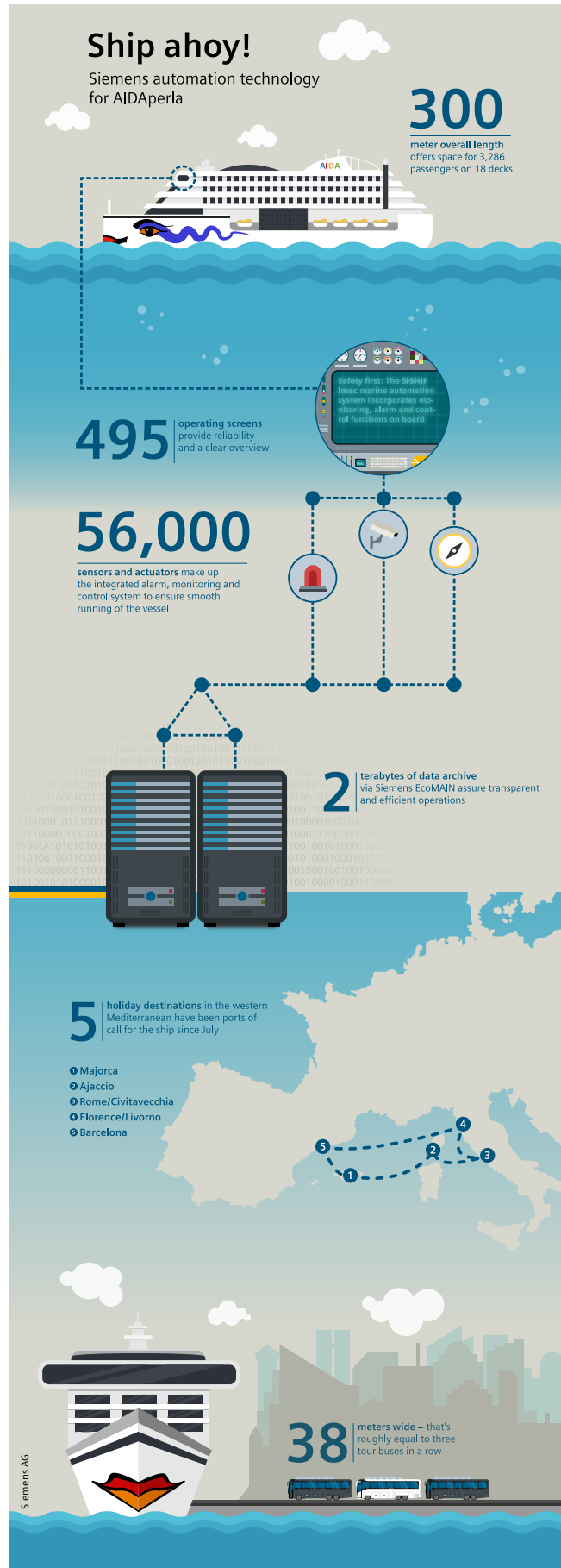

As humans we are land-based and so often we do not realize the huge impact the marine industry has in our lives. At any one time, there are 100,000 ships at sea, from container vessels to cruise liners to fishing vessels and passenger ferries. Trade by sea has grown steadily over recent decades and shows no signs of slowing, but with our increased awareness of the environmental costs of transport, the marine industry is facing the challenge of meeting strict regulations over the coming years. The Simcenter portfolio is uniquely positioned to help with this.



Presenting the LMS Sound Camera

Acoustics are a critical functional performance attribute of nearly every product. High noise levels generated by products or machines can be life- or health-threatening matters or simply degrade the positive perception of a brand or a product. Engineering teams work zealously around the globe to reduce the noise of their products. To outperform competitors, acousticians constantly seek to develop solutions to remove or reduce noise sources. A key step in finding the root causes of sound is to first understand where the sound is coming from. That is less trivial than it seems, especially for complex and large-scale products typically found in marine transportation.

Several traditional alternatives exist to locate sound, such as listener microphones or intensity probes. These give an indication of local sound pressure, or the flow of sound, but they do not indicate the source itself. Furthermore, these time-consuming methods do not work for localizing sources with a transient or impulsive

character. In addition, the results these methods provide are difficult to interpret. Nevertheless, they should be able to justify engineering decisions to further improve products.

Imagine how a discussion on the impact of a tiny peak in a spectrum can be cut short by showing a picture that identifies the responsible component. Array-based sound source localization techniques give results that are accurate, can be measured in one shot and are easy to interpret.

LMS Sound Camera™ Digital Array hardware, which was launched with the LMS Test.Lab 17 software release, is a modular, high-quality digital microphone array for sound source localization. It is an easy-to-set-up-and-use tool that helps both occasional users and engineers perform fast, accurate troubleshooting. The system has been designed to be a versatile solution, with arms that can be added or removed, making it a great tool to work with in multiple test conditions.

LMS Sound Camera Digital Array minimizes the time spent in tracking down sources that contribute to unwanted noise. All electronics are integrated in the array. The device is directly connected to the software application with a single cable. It automatically measures the distance to the source object. Due to its lightweight, aluminum design, the array is robust and shockproof, yet it can be comfortably handheld throughout a measurement campaign. It can be easily and securely transported due to its light but rugged packaging.

The design is suitable for a wide frequency range, both in the far-field and near-field. By adding or removing the short or long arms, which can be done in one click, users can work on objects of different sizes and at different distances. Whether indoors or in the field, on small handheld tools or gigantic manufacturing machinery, close to or far away from the sound source, LMS Sound Camera Digital Array adjusts to testing requirements in every situation.



Siemens PLM

LMS Sound Camera software shows results instantly after being started up. All relevant information is displayed in a single-sheet application in a clear and graphical manner. Users require minimal training. The real-time software is highly interactive, allowing you to change the frequency range and display settings and the averaging method. Any change updates the source location maps, allowing you to accelerate the investigation. Results can be stored in pictures or video, facilitating communication with the engineering teams. The averaging can be modified to better locate transient or stationary phenomena.

For increased engineering insight, the new LMS Sound Camera Digital Array can also be used together with the LMS Test.Lab software, including the new release. In addition to the new LMS Sound Camera Digital Array, LMS Test.Lab 17 includes an improved desktop with additional configurability, updated durability testing solutions, new add-ins for signature acquisition, a new advanced

modal parameter estimator for structural testing and much more. With four built-in auxiliary data channels or a parallel connection to the LMS SCADAS frontend, the localized sources can be correlated with any noise and vibration attribute from a synchronized, multi-channel measurement. For even more advanced processing, engineers can apply state-of-the-art sound source localization (SSL) techniques, such as improving spatial resolution with irregular Near-field Acoustic Holography (iNAH) and deconvolution or quantification of sources, all on the LMS Test.Lab platform.

Whether troubleshooting a disturbing noise on-board, trying to map out the best acoustics in a cabin or supporting the acoustic engineering process of an engine, the LMS sound source localization product portfolio enables customers to enhance the overall product acoustic design. ■

For increased engineering insight, the new LMS Sound Camera Digital Array can be used with LMS Test.Lab software, including the new release.



Becker Marine

A Becker Mewis Duct could save you \$500,000 a year.

Who would have thought fitting your ship or fleet with a simple piece of equipment could save you so much. More than 1,000 ships worldwide have been fitted with a Becker Mewis Duct, a novel power-saving device, which results in significant fuel cost reductions and, of course, much less pollution.

Energy saving devices offer fuel cost savings of hundreds of thousands of dollars per year to ship owners and operators. We talked to IBMV's Steve Leonard, who explains how STAR-CCM+ allows Becker Marine to guarantee those savings across a wide range of vessels.

The single biggest concern facing ship builders and operators is energy efficiency, both in terms of reducing the operating costs, and meeting legislative standards on CO₂ and NO_x emissions.

To a certain extent, these fuel savings can be achieved using modern, efficient hull designs that direct the flow smoothly around the vessel and into the propeller. However, most of the world's commercial trade shipping is dominated by older vessels that were designed without the benefit of modern tools such as CFD and design exploration.

In order to obtain a desirable level of fuel economy and reduced emissions, ship owners and operators often choose to fit energy saving devices (ESDs) to their vessels. ESDs are normally stationary flow-directing devices that are positioned near the propeller; either ahead of the propeller, fixed to the ship's hull, or behind; and fixed either to the rudder or the propeller itself. Experience has also shown that even the most recent hull designs show significant potential for improving the powering performance by fitting ESDs.

The most successful ESD currently in operation is the Becker Mewis Duct[®], a novel power-saving device. It was initially developed for full-form slower ships that allow either significant fuel savings at a given speed, or alternatively, enables a vessel to travel faster at a given power level.

"Something for nothing"

At first glance, the Becker Mewis Duct is a relatively simple piece of equipment, consisting of a duct containing a number of integrated angled fins. The main benefit of the duct is that it produces a net forward thrust, as well as straightening and

accelerating the hull's wake into the propeller. The fin system introduces a pre-swirl into the ship's wake, which reduces loss in the propeller slipstream, resulting in an increase in propeller thrust at a given propulsive power. Both effects contribute to each other. In order to function correctly, both the duct section properties and the orientation and design of each of the fins has to be specifically optimized for each new hull form in order to improve the wake flow from the hull. In simple terms, this can be described as "something for nothing." The Becker Mewis Duct harnesses energy contained in the frictional boundary layer of the hull and uses it to increase the overall hydrodynamic efficiency of the vessel. The power savings that can be achieved from the Becker Mewis Duct largely depends on the hull block coefficient and the propeller's thrust loading.

Typically, you can expect power savings in the range of 3 percent for multi-purpose ships and up to 8 percent for tankers and bulk carriers. Fuel savings on average run 5–to–6 percent and run up to 8 percent when used in combination with a Becker Rudder. The savings in fuel/power that can be achieved is independent of the draft of the ship and her speed. NO_x and CO₂ emissions are also reduced. Becker Marine is so confident in the duct that it is prepared to offer a full refund on any device that does not deliver a certain level of guaranteed fuel savings during model testing. With this sort of guaranteed performance, investing in a Becker Mewis Duct is low risk for most ship owners and operators since return-on-investment (ROI) is typically achieved within a year of installation, and is certainly much cheaper than investing in a new eco-ship. This has proved to be an excellent business model for Becker Marine Systems since the product was launched in 2008. It has now installed over 1,000 devices.

Steve Leonard is the head of R&D at IBMV, a wholly owned subsidiary of Becker Marine Systems, which develops, engineers and launches innovative technological solutions into the maritime market. Leonard and his team performed the CFD calculations for the

» *Without accurate CFD simulations, we wouldn't be able to tune each duct to the specific flow conditions generated around each hull.*«

Steve Leonard
IBM, Head of R&D

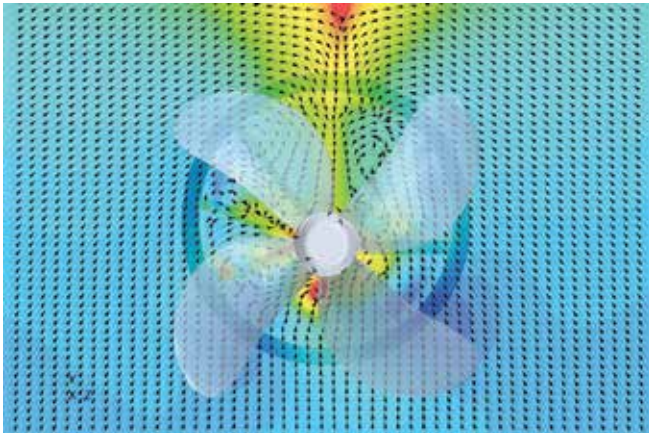

first Becker Mewis Duct in 2008, and have subsequently developed a process (which employs 13 engineers and naval architects) that enables them to deliver hundreds of ducts per year.

“The success of the Becker Mewis Duct depends almost entirely on the CFD process that we use to define it,” says Leonard. “Without accurate CFD simulations, we wouldn't be able to tune each duct to the specific flow conditions generated around each hull. Although there are similarities, the duct that we design for each vessel is absolutely unique and a result of the careful tuning of over 40 design parameters. No two are ever alike.”

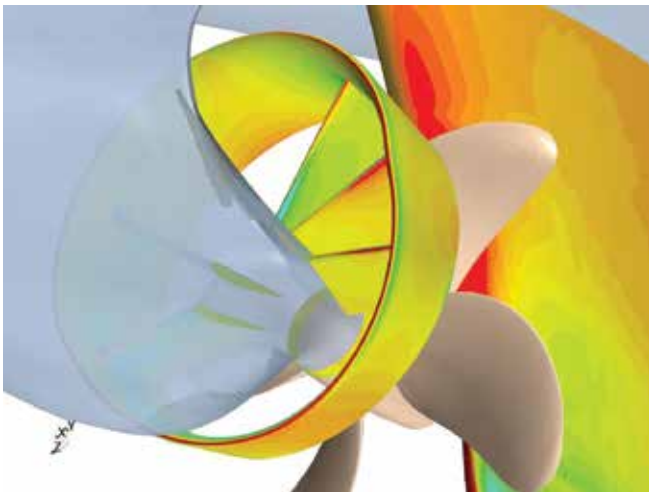

Not only does Leonard's team have to deliver guaranteed energy savings, they also have to deliver them within a strict time frame. “From the moment we receive a new order, we typically have six weeks to find the required energy savings,” says Leonard. “This timescale is strictly fixed by the fact that the towing tank slot is reserved well in advance and cannot be moved. If we can't improve the energy efficiency of a given vessel within that time, then we've basically failed. There are no second chances.”

The marine industry tends to be conservative, and self-propulsion tests remain the benchmark for proving the powering performance of vessels for most shipbuilding contracts. Few customers are even aware of the intensive CFD effort that goes into designing and tuning their Becker Mewis Duct, concentrating only on the fuel savings demonstrated during model testing. Any variation between CFD and towing tank predictions is investigated thoroughly using further CFD calculations.

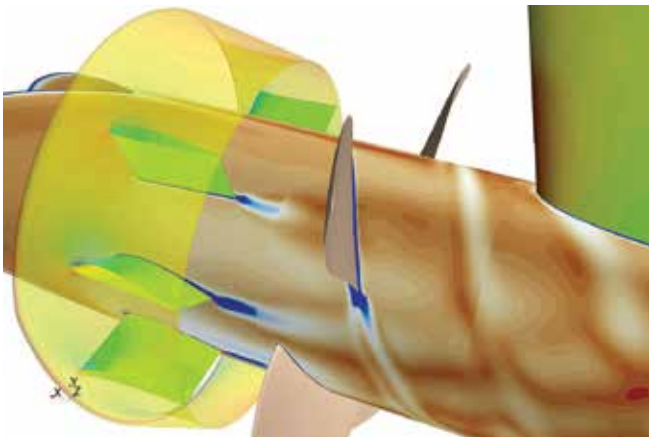

The vast majority of CFD calculations is performed at model scale. To verify that scaling effects do not have a significant influence and also ensure good cavitation performance, the IBMV team runs a series of final full-scale calculations. Although this problem seems well suited for an automated optimization process, in which a computer algorithm chooses the next design configuration (rather than a human), based on the parametric exploration of previous iterations, the Becker Mewis Duct does not lend itself easily to automated design exploration.

Wake velocity behind the duct (top), pressure distribution on the duct and rudder (middle), and vorticity magnitude on a cylinder section inside the duct (bottom).

The reason for this, Leonard explains, is that it is almost impossible to reduce the flow around the duct to a handful of numerical parameters that could be used to fully define the next design iteration. Instead, Leonard relies on a team of experienced naval architects and hydrodynamicists who visually inspect all data that is automatically generated at the end of each STAR-CCM+ simulation, and identify adverse flow features through the duct, fins and propellers. They suggest corrective action for the next iteration. In most cases, the team is able to obtain optimal energy savings in about 10 design iterations, although some credit here must also go to the experience of Leonard's team. With their experience of fine-tuning many hundreds of these ducts, they are able to use their engineering judgment to define an initial design that offers a solid foundation for further improvement.

The better designed the hull of the vessel is, the less energy is wasted in the wake, and the harder it is for Leonard's team to obtain big savings. With some excitement Leonard fondly recalls the team's solitary one-and-done duct design, in which it was subsequently shown that the initial design iteration delivered the required energy saving without the need for any further optimization. In reality, this is also a victory for the IBMV process, as the initial design was configured by an engineer who used knowledge from the hundreds of previous duct design studies when choosing the design parameters for this particular duct.

The success of IBMV in delivering over 1,000 Becker Mewis Ducts offers a clear demonstration of the value of engineering simulation (and CFD in particular) as a tool in the marine design process, informing decisions and providing a constant stream of data to improve the real-world performance of vessels.

Without intensive design exploration driven by experienced engineers, it would be impossible for Becker Marine Systems to deliver finely tuned energy-saving devices that offer guaranteed performance in a strictly controlled time scale. Not only has this delivered millions of dollars of fuel savings to their customers, but it has also played a significant role in reducing harmful CO₂ and NO_x for the shipping industry as a whole. ■

Becker Mewis Duct facts

The Becker Mewis Duct was first introduced to the market in September 2008. The first full-scale installation was completed on the 54,000 tons deadweight (TDW) multi-purpose carrier STAR ISTIND of the Grieg Shipping Group, Bergen, Norway in September 2009. The estimated power saving for that ship is about 6 percent.

The AS Valeria, a 57,000-TDW bulk carrier, achieved fuel savings of 5 percent (predicted by CFD and confirmed in sea trials) resulting in the reduction of 1,002 tons of CO₂ per year.

A vessel of 55,000-TDW will use about 160 tons of fuel per day at normal cruising speed. Over the course of a year, a 5 percent improvement in fuel consumption would save over 2,000 tons of fuel over the course of a year, resulting in cost savings of around \$500,000.



A view from the front line: simulation at Wärtsilä Propulsion

Norbert Bulten's relationship with STAR-CCM+ software goes back nearly 20 years. As head of hydrodynamics at Wärtsilä Propulsion, he has worked with the software and its previous versions since the mid 1990s. A lot of things have changed, both in the shipping industry and the world of computer simulation in that time, but what hasn't changed is his vision of simulation as a vital tool in the design process. We recently sat down with him to talk about the simulation history at Wärtsilä, the challenges facing the shipping industry, and how Wärtsilä's progression towards a digital twin will take their simulation use into the future.

Early days: CFD proves its worth

Bulten has been involved in hydrodynamic design since his university days, working first at LIPS, which was acquired by Wärtsilä in 2002. Computational fluid design (CFD) was always part of his role. "We started at the waterjet department with STAR-CD® software (the precursor to STAR-CCM+), doing CFD and finite element analysis on inlet ducting for water jets with an aim to optimize the flow into the propulsion unit," says Bulten. From there, he moved to modeling a simple open propeller, then gradually built up to include the thruster housings, and eventually moved on to include the hull geometry in front of the propeller. He remembers working closely with Siemens staff to create a parametric model for creating and automatically meshing the waterjet inlet geometry and later on, the propeller blades. "We were efficient from the start," says Bulten. "We always spent time writing scripts to automatically create and run our cases. Spending time in scripting pays off in time savings later on, and that is still true today."

In its early days, CFD was regarded with suspicion by many in the shipbuilding industry. With years of experience in design and testing in a towing tank, and confidence in the results, why, people argued, should we look at a computer-based model? Companies such as Wärtsilä have one overriding aim: to produce hardware that works. Customers are interested in the final result, not in a report on findings. Bulten recalls the pragmatism of a former manager who said, "It doesn't matter how colorful your pictures are, if the boat does not run at 40 knots they will throw you overboard." Generally, towing tank testing provided results that let engineers create products their customers wanted. CFD could produce interesting results, but was not perceived as a solution to any particular problem.

This started to change when Bulten and his team worked on troubleshooting problems. Bulten explains, "We had a case where a ship started sailing and the inlet ducting didn't work properly. It turned out that the unit was not built according to the proper drawings and therefore the waterjet was not working as expected. We were able to run some quick simulations on the existing

design and suggest some changes that could be made via welding. Within a week the shipyard was able to make these really subtle modifications, the ship worked much better and the shipyard could sell it. Due to CFD, we knew where to make the modifications. When the ship was sailing, we had instant feedback that they worked." This case showed the benefits of CFD in solving a problem and also validated the CFD results. This success was a clear confirmation of Wärtsilä's strategy to incorporate CFD into the design process from the start. "The next ship could accelerate from 0 to 55 knots within a minute, which showed that using CFD properly could help to create great designs," says Bulten. "From this point on, there was no discussion in the team. CFD would always be part of the design process going forward."

STAR-CCM+ is still used to troubleshoot designs if needed. Bulten believes it is an obvious choice in these cases. "Often, looking at the CFD results it is easy to understand what is happening, and why something has failed. Once you understand what is happening the solution to the problem is often obvious. We can share these results with the customer. Showing we have this understanding of the flow dynamics can add credibility."

Adapting to challenges: improving efficiency

The marine industry has also changed over the years, certainly in response to stricter regulations on fuel efficiency. "Ship owners first became interested in energy saving when the oil price was high," explains Bulten. "When the oil price dropped, efficiency stayed a key issue, mostly due to regulations which came into force over those years." Current IMO strategy requires new ships to be much more energy efficient: by 2025, new ships must be 30 percent more efficient than those built in 2014. At the same time, all existing ships must have an energy management plan to improve all aspects of operation, including upgrades to the hull or propeller if required. For manufacturers, such as Wärtsilä, there are two different approaches to meeting these regulations. New ship designs are optimized from the start, making sure that each component is as efficient as possible in the



Norbert Bulten
General Manager
Hydrodynamics, Wärtsilä

early design stages. For existing ships, Wärtsilä works on creating new propellers and a range of optimizing devices that can be retrofitted, thus improving ship performance. “In some ways, we can see a greater efficiency improvement by retrofitting an older ship,” notes Bulten. “Modern designs are already so optimized that improving the efficiency can be much harder. But efficiency savings can still be found, especially if CFD is employed early in the design process. If you can be influential at the drawing board, you will have a huge impact on fuel efficiency.”

In one recent new design, early CFD simulations indicated that one head box showed significantly more resistance than the other. The CFD team worked with the designers to investigate this issue and proposed some alterations. When the new design was simulated, it showed a 3 percent reduction in resistance from the original. “At the design stage, it is much easier to make a change. An efficiency improvement of 3 percent seen over the entire lifetime of the ship is significant,” says Bulten.

Full scale simulation: the future

Within Wärtsilä, CFD is regarded as an important tool. This is not always the case in the wider marine industry, though, and customers are often insistent on using towing tank testing. “Occasionally we are challenged to a model test competition with other manufacturers,” says Bulten. “Of course, we could focus on producing an appropriate design capable of winning this kind of model test, but we know that we have the capability to produce far more efficient designs. Our message to customers has to be that if you wish to test us in this way, we are ready to participate, but the final propeller will almost certainly be more efficient if we use full-scale CFD results in the design process instead.” Norbert Bulten is convinced that full-scale simulation is the only possible option for future design success. “We are now working on new propulsion devices in which the design choices are based on the calculated full-scale performance instead of the conventional model scale which will not predict the same levels of benefit,” says

Bulten. “However, if they work as predicted by our full-scale simulations we will see a change in perception across the industry in the next few years, with a move toward full-scale simulation as default. This needs to happen if we are to continue to improve marine designs, and we need to help spread the message and educate our customers.”

Model testing still has a role to play in ship design, as seakeeping and wave tests can be run quickly in a towing tank. Reynolds effects are less of an issue in these tests. But when it comes to understanding the complex interaction between the different hull components, full-scale CFD simulation is needed. “Rudder, nozzle, propeller – all of these things work together,” notes Bulten. “With our computer models, we can understand all of these and make improvements to the complete system. We need to look beyond model tests of single components to understand all possible interaction effects in one simulation.” Interestingly, the most efficient design is not always the most obvious one. Bulten explains, “A few years ago, the ship designer would have made the hull to have as low a resistance as possible, and the propeller would have been designed to have the highest possible open water efficiency. But these days, we can look at both together and consider the overall efficiency. We may decide to accept a slightly lower efficiency on the propeller if, when combined with the hull, the overall efficiency is better. We want the overall power required to propel the complete ship to be as low as possible, after all the fuel bill is for the entire ship.”

Towards a digital twin

After 20 years of working with CFD and simulation, Bulten is confident that there are still innovative ways to work. “We have almost everything needed for a digital twin available now,” adds Bulten. “We can take full-scale monitoring data and our software tools, and look to model even more of the system. The more we can model, the more we can understand and the more efficiencies we can uncover.” Bulten recently presented a case in which he had simulated a self-propelled ship in STAR-CCM+, and coupled it to LMS Imagine.Lab Amesim to



Installation of Wärtsilä Fixed Pitch Propeller Systems and Wärtsilä Energopac rudder.

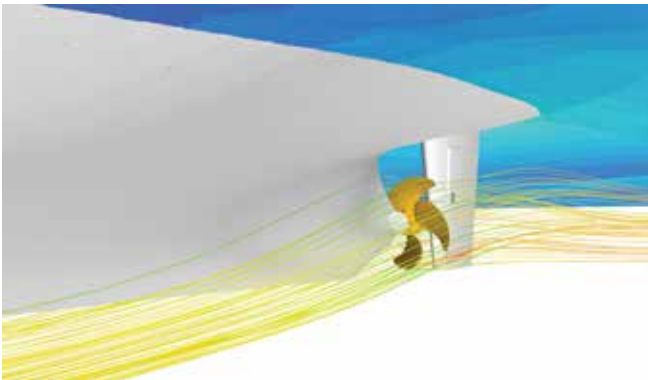

Full-scale CFD simulation enables modeling of hull, propeller and rudder, giving an understanding of the interactions between them.

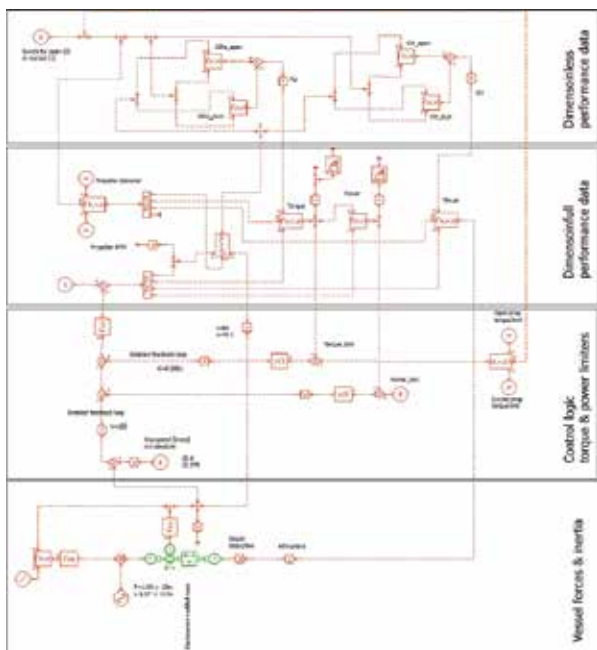

Example of LMS Amesim model calculating engine thruster responses. This is coupled to STAR-CCM+.

simulate the thruster mechanics. He says, “We wanted to compare the performance of a ducted propeller and an open propeller. In calm water, an open propeller is generally good, but is this the same in rough seas when resistance is higher? Using LMS Amesim, I could investigate what happened if torque limit starts to play a role. Basically, we could prove that at 12 knots the hit for an open propeller is much harder than for a ducted one – your RPM drops, and you deliver less thrust, and therefore less speed, and this could get into a negative spiral. In the future we can add far more dynamics into the LMS Amesim model. Another example is that of hydraulically operated pitch-actuated propellers. At the moment it is hard to verify the pitch actuation forces. We could model the entire hydraulic system, calculate the position of the propellers and get the loads (shaft torque, spindle torque, thrust) from the CFD model and compare the hydraulic pressure levels with measurements. The initial approach shows what is possible. STAR-CCM+ and LMS Amesim are both part of Simcenter, which helps optimize design and deliver innovation faster.”

The increased power of simulation, including these new coupled systems, have in part become possible because of the massive increase in computing power over the years. Bulten has seen this first hand: “When I first started, I remember setting two inlet design cases to run over a weekend and being ready to analyze them on a Monday. Within a few years, we could run the same design case in 15 minutes. Every year you can do more with the software in less time. We can’t stand still. We can do more so we should continuously stretch ourselves and increase the scope of our work.” With this view, Bulten has recently linked STAR-CCM+ to Optimate, the design optimization software and also to NX CAD. “We are very pleased with it so far,” he comments. “We are only just starting to run cases with it, but are already seeing huge potential. Last week, we started with a very bad propeller design and using STAR-CCM+ and Optimate, we identified a substantial efficiency improvement, but I know we can do even better than this. There are more geometry parameters we can run sweeps over, and the whole process can be scripted to make it even faster. These design optimization tools should bring us to the best geometry faster. Then we can investigate that final geometry to understand why it is a good design. In all we do, we must make sure we understand what is happening. Understanding is an important part of the engineering process.”

Wise words indeed from an experienced engineer. Wärtsilä’s use of simulation shows the level of understanding that can be gained beyond a scale model tank test, especially by looking at the interactions between different components. With engineers like Bulten using simulation in ever more advanced ways, the future of the digital twin as a design and analysis tool looks promising. ■

continued from page 7

conditions? How to make sure sensors can withstand an aggressive maritime environment and rough climatic conditions? How can complex and extensive maritime legislations and conventions be programmed in control algorithms? And how to guarantee safe connectivity to and communication with land-based systems at any time, from anywhere? As marine architects and engineers, these are some of the most important challenges today.

The digital twin paradigm

It's clear that all these innovations, including structure and shape optimization, mechatronic system design and continued updating over the entire vessel lifecycle, will largely depend on the availability of digital technologies. Design engineers will need an environment to virtually, but realistically, test multiple new ideas within a short timeframe, detail selected concepts while simultaneously staying closely connected to individual vessels after commissioning to follow-up on monitoring, maintenance and updates. This process will let marine manufacturers bring complex and optimized vessels to market more effectively, and track vessel operation and performance from cradle-to-grave. This entire process will also lead to huge and continuous data streams that need to be collected, managed and analyzed.

One way to execute and organize such lifecycle-spanning activities is to develop a set of highly accurate models in parallel with the real vessel development and its useful life. These cover multiple scales and processes of the ship, simulating and predicting many different physical aspects. The models can be examined individually to focus on one design or operation aspect, or linked together to predict complete ship operation. This collection of models can be called the digital twin. The ideal digital twin tracks information on all parameters that define how each individual ship behaves over its entire lifespan, starting from initial design and further refinement, to manufacturing-related deviations, modifications and uncertainties, and to updates and history. Implementing a full digital twin approach could help significantly shorten the development time, improve performance, lower operational cost and reduce risk.

Even though some organizations may already be using a digital twin for some purposes, especially for design and development, the degree to which digital modeling combines individual activities in a comprehensive approach is usually small, particularly when considering the entire lifecycle.

Use of the digital twin in the marine sector lags behind the automotive and aviation industries. This slower adaption originates partly from industry-specific differences, such as research and development budgets, production volumes and manufacturing methods. But to make the digital twin approach fully applicable, the marine industry will have to come up with new methods and revolutionary technologies as well. In the future, real load and boundary conditions

will be required to allow more accurate modeling, along with multi-disciplinary simulation that combines physics and tightly couples disciplines. This will enable shipbuilders to simulate entire ship systems. This approach will require more robust data management systems as well as software and hardware for increased computational power.

Presenting Simcenter

Enabling this full digital twin is exactly what Siemens PLM Software is doing. Our goal is to offer the marine industry the most comprehensive, state-of-the-art solution to build and maintain a digital twin. As a world-leading provider of product lifecycle management (PLM) solutions, we help thousands of companies across various industries and around the globe realize innovation by optimizing their processes, from planning and development through manufacturing, production and support. So converting the digital twin vision into an infrastructure with concrete solutions is a natural fit for us.

With the Simcenter solutions portfolio, customers can access a holistic set of methods and technologies to support the entire development cycle and help deliver innovations for complex products faster and with greater confidence. Simcenter enables you to integrate 1D simulation, 3D computer-aided engineering (CAE), controls, physical testing, visualization, multidisciplinary design exploration, and data analytics in a managed context. It combines decades of experience by putting well-known products, such as LMS Test.Lab software, LMS Imagine.Lab software, NX Nastran software, Femap software, STAR-CCM+, HEEDS software and more under one umbrella. And it features Simcenter 3D as the combined successor of NX CAE, LMS Virtual.Lab software and LMS Samtech software. This portfolio of solutions will allow ship designers and builders to follow a more efficient design and commissioning path and reduce the acquisition cost for fleet owners.

This vision does not stop there. By connecting Simcenter to Teamcenter as an underlying data management system, we will be removing all boundaries that exist between design and life-after-delivery. In the long run, this could replace the current standard practice of vessel handover from builders to operators and replace it with a shared ownership model for individual vessels, with constant updates provided until end of life. The possibilities are endless. Self-healing mechanisms, proactive damage control and history-based updating of intelligent systems are just a few examples. It's obviously hard to say which new application will come first or definitely state a timeline. We can only agree with Niels Bohr and say that prediction is indeed very difficult, especially if it's about the future. But we at Siemens will do all we can to deliver the required infrastructure to help develop the digital twin to its full extent and create innovative digital technologies to deal with the marine challenges of the future. ■

➤ [siemens.com/simcenter](https://www.siemens.com/simcenter)



SIEMENS

Ingenuity for life



Today's dreams need
tomorrow's engineering.

**Simcenter: Predictive engineering analytics
for the new era of smart innovation.**

Getting a dream rolling has never been more challenging. Products are smarter. Manufacturing processes are more complex. And design cycles are shorter than ever. Simcenter software can help. With its unique combination of multi-disciplinary simulation, advanced testing and data analytics, Simcenter gives you the power to explore alternatives faster, predict performance more accurately... and deliver innovation with greater confidence.

[siemens.com/simcenter](https://www.siemens.com/simcenter)

Colophon

Director of publication: Peter De Clerck

Editor-in-chief: Jennifer Schlegel

Creative Director: Werner Custers

Editorial team and contributors: Chris Beves, Joëlle Beuzit, Adèle Dolique, Deborah Eppel, Julie Ercolani-Peck, Stephen Ferguson, Raphael Hallez, Elspeth Mosedale, Rajesh Ramaya Selvaraj, Leonie Upton, Bart Van Lierde, Els Van Nieuwenhove and Charlotte Zhang.

Production: Els Coenen and Cindy Piskor

Although we make every effort to ensure the accuracy of Simcenter News, we cannot be held liable for incorrect information.

© 2017 Siemens Product Lifecycle Management Software Inc. Siemens and the Siemens logo are registered trademarks of Siemens AG. LMS Imagine.Lab, LMS Imagine.Lab Amesim, LMS Samtech Samcef, LMS SCADAS, LMS Smart, LMS Sound Camera, LMS Test.Lab, LMS Virtual.Lab and Simcenter are trademarks or registered trademarks of Siemens Industry Software NV or any of its affiliates. Femap, Fibersim, HEEDS, NX and Teamcenter are trademarks or registered trademarks of Siemens Product Lifecycle Management Software Inc. or its subsidiaries in the United States and in other countries. STAR-CCM+ and STAR-CD are trademarks or registered trademarks of Siemens Industry Software Computational Dynamics Ltd.

NASTRAN is a registered trademark of the National Aeronautics and Space Administration.

Becker Mew Duct is a registered trademark of Becker Marine Systems.

All other trademarks, registered trademarks or service marks belong to their respective holders.

