



SIEMENS

Ingenuity for life



Siemens Digital Industries Software

Simcenter for electromagnetics

Meeting the challenges of Industry 4.0 in
the automotive and aerospace industries

Executive summary

What happens to the sensors on your car when it rains? How does your cell phone automatically know what the traffic is like? How can you redesign the most energy efficient and safe electric vehicle (EV)? How is an Airbus A350 protected from radar interference or a lightning strike?

Over the last 25 years, electromagnetic engineering has revolutionized the way we work, travel and communicate. It is omnipresent in our lives, playing an essential role in the sustainable and connected world we live in. Its role will only increase as the Internet of Things (IoT) and Industry 4.0 start to change the way we interact with products as well as improve energy efficiency and manufacturing processes.

Contents

| | |
|---|-----------|
| Abstract | 3 |
| Electromagnetic basics | 4 |
| High or low frequency? | 4 |
| Surmounting complexity and scale | 5 |
| Industry 4.0 and the renaissance of the electrical machine | 6 |
| Electromechanics and electromagnetics in Industry 4.0..... | 7 |
| Electric motor design approaches: a holistic approach . | 7 |
| Taking a complete field physics approach | 8 |
| Designing motors for automotive and aerospace | 9 |
| Electromagnetic simulation details of a traction drive.. | 9 |
| Actuators and other force-producing devices | 12 |
| The connected society and electromagnetics | 13 |
| A digital twin approach to support HIRF and IEL aircraft design and certification..... | 14 |
| High-intensity radiated field regulations at a glance .. | 15 |
| A digital twin approach to support HIRF and IEL aircraft design and certification | 15 |
| Electromagnetics and advanced driving assistance systems..... | 18 |
| Electronic circuits are everywhere – How to handle EMI/EMC issues | 20 |
| Electronic circuits are everywhere | 20 |
| Conclusion | 21 |

Abstract

As simulation technology and computing power become more advanced, it will be possible for Industry 4.0 engineers and analysts to implement a spectrum of electromagnetic scenarios for all types of digital twins, from connected cars and appliances to the automated factory where they are produced.

Covering applications across various engineering fields, electromagnetic simulation is not a one-size-fits-all task. It is a complex exercise that involves design teams, analysts and testing experts who require different types of cut-for-purpose simulation and design tools. Throughout this paper, we will highlight some of the current electromagnetic solutions and toolsets that are part of the Simcenter™ portfolio, focusing on several cases in the aerospace and automotive industry.

To start, we will cover the basics, including low- and high-frequency approaches to solve electromagnetic problems in Industry 4.0 applications. Then we will highlight some of today's innovative electromagnetics. First, we will review traction drive and actuator development. Then we will take a look at how the European aerospace industry is approaching electromagnetic simulation for countering indirect effects of lightning (IEL) and high-intensity radiated fields (HIRF), both key topics in electromagnetic compatibility (EMC) related certification. Then we will look at the progress being made to enhance advanced driver assistance systems (ADAS) and sensor performance in the automotive industry. We will finish our white paper with a look at EMC and electromagnetic interference (EMI) problems in hybrid-electric vehicles and EV powertrains and investigate potential solutions to address this growing concern.

Electromagnetic basics

The origins of the electromagnetic field are found in the pioneering work of British scientist Michael Faraday and French physicist André-Marie Ampère in the early 1800s. The Scottish scientist James Maxwell amongst others improved the basic concept, suggesting electromagnetics was a field rather than a fluid in the 1860s. This led to a complete understanding of electromagnetic field behavior well over 150 years ago, including the fact that energy could be radiated.

Two centuries later, you probably wouldn't give all this a second thought, but electromagnetic fields are fundamental to the success of a connected and sustainable society. They can convert and transmit energy as well as transfer basic information. They cover space and can propagate without the need for a transmission medium. Electromagnetic fields are invisible, yet we know they exist by the forces exhibited on materials placed in them. By changing the field structure, information can be transmitted wirelessly between a source and a receiver. By placing materials in the field, distribution can be used to generate mechanical forces and the field becomes an energy storage system. In other words, electromagnetics is responsible for some significant developments (or devices, as industry insiders like to say), like sensors, electric motors, induction hobs and even superconducting magnetic energy storage (SMES) systems.

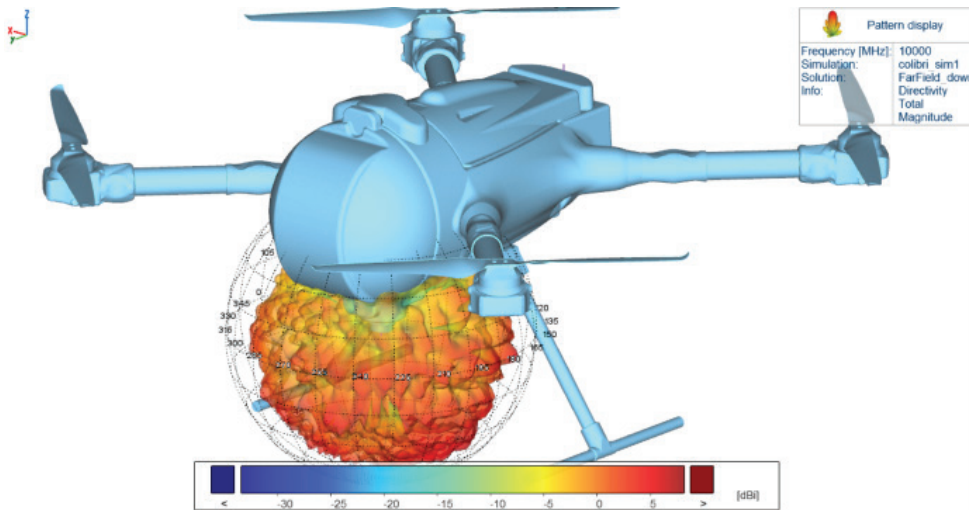

Antenna siting and design is a typical high frequency application as shown here on the Colibri drone.

High or low frequency?

Since electromagnetics is not a one-size-fits-all job, experts typically categorize issues according to whether the electromagnetic field changes are radiated or not. This gives rise to two categories often referred to as high- or low-frequency electromagnetic problems. Each one has its own typical characteristics and methodology. For the sake of simplicity, we will continue to refer to our electromagnetic examples as such even though it is not always an ideal way to explain it.

In general, classifying low- and high-frequency electromagnetics depends on the electric size of the system. This is essentially the ratio of the size of the physical system versus the wavelength of the electromagnetic wave. For example, an electric motor with a dimension of one meter running at a 50 hertz (Hz) net frequency produces a 6,000-kilometer (km) wavelength. The ratio of size-to-wavelength is about 0.00017, propagating inside the electric motor. This would be considered a low-frequency project.

There are several common applications of low-frequency electromagnetic fields. These include energy conversion between mechanical and electromagnetic systems, such as motors, generators, actuators and microelectromechanical systems (MEMs). This also includes conversions between electromagnetic and thermal fields, such as

induction and resistive heating as well as energy transmission between two closely located structures, such as wireless charging systems. There are sensing systems that rely on field changes, including material property changes, like non-destructive testing, velocity sensing and near-field transmission.

On the opposite side, let's look at a high-frequency example, like radars used in automotive ADAS. Typically, these radars operate at 77 gigahertz (GHz), corresponding to roughly a four-millimeter (mm) wavelength in a vacuum. In this case, the ratio between

the size of the system (the vehicle) and the wavelength is about 500. The wave would propagate and scatter around the vehicle and the environment. This would be categorized as a high-frequency project.

Surmounting complexity and scale

All electromagnetic devices have something in common: complexity. They typically require complex shapes to define the desired field structure. The materials used often behave in a nonlinear fashion (for example, the relationship between magnetic fields and magnetic fluxes are variable). The field wavelength is much larger than the overall device dimensions. For example, a one megahertz (MHz) wavelength in free space is about 300 meters, so any device with a few centimeters as its maximum dimension will have negligible radiation. Another major challenge that experts tend to take for

granted is scale. Unlike many other areas of physics, the range of scale in a device is huge. As an example, for a transformer you must consider components that are submillimeter in size in a device in which overall dimensions are measured in tens of meters. This is a scale factor of at least 10,000 to 1. In certain aerospace applications, you have features that are submillimeter in a structure, which is tens of meters in size. How do you handle issues of scalability in both low-frequency and high-frequency scenarios? This is another challenge that is specific to overall electromagnetics and one that we will touch on as well. As you can see, there are quite a few factors to take into consideration for every electromagnetic puzzle throughout the frequency range. To start, we will focus on several approaches related to energy conversion in an electrical machine, a classic electromagnetics application.

Industry 4.0 and the renaissance of the electrical machine

Electrical machines are not new. The basic concept of an energy-conversion device taking electrical energy and converting it to mechanical output or vice versa has been around for roughly 200 years. Recent developments in material properties, power electronics, embedded control systems and manufacturing technology have had a significant impact on what an electrical machine not only looks like and what it can do, but also how it is manufactured.

New materials, 3D printing and smart appliances aside, designing an electrical machine is obviously not a one-stop process. Maybe you are working on an EV motor or a generator. Perhaps it's a fixed installation or a mobile system. Maybe you are updating the design of a home appliance. Or maybe you are reworking the layout of an Industry 4.0 manufacturing plant. The design objectives of an electromagnetic device can vary considerably. Sometimes you just might need a quick feasibility study or a budget estimate. Other times, you need a more in-depth analysis that dives into the details. Sometimes you need a high-fidelity digital twin for certification purposes. In most cases, you aren't the only person working on this aspect of the product. Electromagnetic tasks tend to branch across the development teams from designer to controls engineer to analyst, which is why Simcenter solutions for electromagnetics offer a scalable variety of digital twin tools.

In addition to the daily engineering to-do list, experts today often face different design issues. Traditionally, electrical machines were run at constant speeds with long duty cycles. Transportation systems only needed to ensure the starting torque was sufficient and the characteristic torque-speed curve matched the intended driving performance. At the time, this was often most easily achieved with direct current (DC) motors. In many cases, the designer could just assume a fixed voltage and frequency for the electrical supply.

Today, in the age of sustainability, this has all changed. Many engineers are constantly challenged to improve efficiency and overall machine performance. The arrival of power electronics, sensor technology and digital control has completely reinvented the game. Today, it is typical to modify the supply voltage and excitation frequency based on output requirements. For example, an EV motor may be designed to optimize efficiency over drive cycles. This requires meeting torque and speed requirements at every point during the operational envelope while maintaining the highest possible efficiency. (The higher the efficiency, the longer the battery life and, consequently, the greater the range.)

But it is never just about efficiency. Today another high priority requirement is reducing costs. Cost consists of two major components: basic materials and manufacturing. Reducing material costs suggests less expensive materials should be used and the volume of materials should be reduced. Simplifying or rethinking the design or business model and 3D printing can have an impact here, but this is more of an exception than reality today.

With larger production runs for items such as home appliances, automated manufacturing constraints limit the design geometry and can hinder attempts to optimize and improve performance factors. Finally, factors for material property variations as well as manufacturing errors must be considered. In many cases, this means the product design

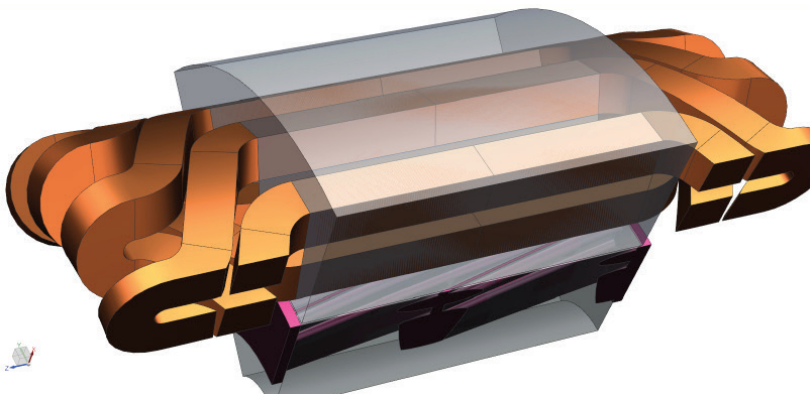

Partial model of an induction motor with a skewed winding.

or digital twin must be flexible enough to compensate for these variables.

Electromechanics and electromagnetics in Industry 4.0

What does all this have to do with electromagnetics? Maybe it is best to step back a bit. Although the electromechanical conversion process is the basic goal of any electrical machine, operating the machine can cause a variety of side effects. For example, all conversion processes involve some form of loss. In an electrical machine, the result is heat loss, resulting in an increase in temperature both locally and globally. For example, in a 70-kilowatt (kW), 95-percent efficient traction motor, the heat loss can reach almost 4 kW at full operational output. This must be removed or the temperature increase could cause permanent damage, such as insulation failure or permanent magnet demagnetization. The good news is most traction motors operate at only 10 to 20 percent power-rate capacity most of the time. This means when designing a motor today, the drive or duty cycle becomes a critical performance factor while the thermal design of the motor needs to include the effects of heating loss.

Energy can also be lost via other mechanisms, including noise. For example, the force waveform created in the air gap of an electrical machine is not constant. The forces on the rotor and stator depend on time and the relative position of the two components. These forces not only generate the torque or force output of the machine, but can also produce time-variant structural distortions, causing vibrations. Under certain circumstances, the stator can resonate, causing significant vibrations, which can stress the mechanical structure and potentially lead to structural failure as well as unwanted acoustic noise.

Even though the primary design of an electrical machine can be a purely electromagnetic exercise, the impact of the electromagnetic fields can easily affect other areas of physics in the overall product or device. This introduces a serious level of complexity into the design and development process, an issue which is best solved using a multiphysics solution to examine performance elements, such as thermal, cooling, fluid dynamics and structural, durability and acoustics. A multiphysics approach is the best possible option to generate an accurate digital twin, which is sufficiently optimized despite conflicting performance objectives.

Depending on the issue at hand, electromagnetics experts will have to decide what is the best possible methodology

and toolset. Digital twins play a vital role here but choosing the right digital twin approach is an essential part of solving the issue in the most effective manner. Today, digital twins with electromagnetic analysis capabilities can handle more holistic behavioral studies that investigate multiphysics as well as the pure physics studies requiring more precision for complex or puzzling issues. Let's take this a step further and look at some of the advantages and disadvantages of these two approaches.

Electric motor design approaches: a holistic approach

As part of the design process, simulating the correct performance under expected operating conditions is crucial to creating an accurate digital twin. For electromagnetics, central to this process is creating an analytical system model that can be used to determine reasonably accurate output according to a structure and set of excitations. In other words, the electromagnetic simulation is part of the greater behavioral model. In more formal terms, this is often referred to as a magnetic-circuit approach. Although accurate component values can be determined from the geometry and material properties, the assumptions embedded in the model mean such a circuit needs to be calibrated to correct the computed values. The required calibration process can be implemented with a set of tests on an existing device or a hardware-in-the-loop (HiL) approach. In the simplest form, these are classic load and no-load physical tests. Although this approach provides a designer or analyst with a fast and reasonably accurate tool, it limits the design space and may not be the most innovative or accurate approach.

The second approach is based on physics rather than estimated behavior. The positive side is with this method there aren't any assumptions about flux paths. On the other hand, this approach generally doesn't take holistic device behavior into account. It is geared to solve the electromagnetic field problem by considering material behaviors and detailed geometric structures without any assumptions about a device's magnetic field behavior. It computes the field everywhere in the device based on the fundamental electromagnetics equations. This approach provides a certain level of confidence about the accuracy without calibration. In this case, the level of accuracy depends on the model's precision and the assumptions built into the physics solution. To achieve the best-possible accuracy, a complete field physics approach requires specific geometry and an accurate representation of material behavior.

Taking a complete field physics approach

When considering the two approaches, a key decision factor is time. Although a holistic behavioral method might not be the most accurate, it will give you a good idea rather quickly if a design concept will work. For more enigmatic issues, the complete field physics approach requires a serious time commitment to model a highly accurate digital twin. So why is it necessary to generate a full physical model if you can get fast and sufficiently accurate predictions from a decent circuit approach? The major advantage of a complete field solution is the field inside any object can be determined at any point. For example, this means vital design data obtained from the digital twin – such as local losses and thermal effects in an electric motor – can be considered highly accurate and helpful for solving other critical issues later in the design process. For example, when

designing a motor, the data gained from a complete field study can provide insight into the force distribution in the air gap and the effects of ripple forces and motor vibrations on the design.

Now that we have reviewed the current market implications, history, definitions and common methodologies for electromagnetics, it is time to review some case examples from the Simcenter portfolio. Reverting to the idea that electromagnetics is not a one-size-fits-all domain, we want to stress the cases discussed offer the best possible solution from a selection of toolsets and methodologies. Since we just touched on the topic in the last section, let's continue to dive further into the details of electromagnetics and motor design, looking to correctly model mission-critical design tradeoffs for material choice and operational efficiency.

Designing motors for automotive and aerospace

From Industry 4.0 automotive and aerospace manufacturing to heavy equipment, innovative electric motor design and development have become industry make-or-breaks. Not only are high performance, sustainability and efficiency at the top of the list, significant drivers like the cost of materials, manufacturing and operation are also vital factors in the design and development process. For electromagnetics, accurately representing material behavior and related local loss determinations will help predict machine behavior from a design point of view.

A good example is the traction drive. Engineers have been looking at the use of synchronous reluctance motors to significantly reduce manufacturing costs by removing the expensive permanent magnets (often neodymium magnets). This can lead to a significant loss of torque for certain frame sizes. To overcome this, relatively cheap permanent magnets (alnico or ferrites) can be used within the flux barriers to increase the torque of the machine without significantly increasing costs.

But just substituting magnets isn't enough to reach required performance levels. Real-life operation needs to be calculated as well. It is difficult to optimize the performance over the entire operational envelope by using traditional design tools or building prototypes. Simulation is the only answer for handling multiphysics performance and exploring the design space for an optimal solution. Using advanced engineering solutions like Simcenter 3D and other electromagnetics tools, such as Simcenter MAGNET™ software, users can integrate their digital twins seamlessly into existing product lifecycle management (PLM) environments based on Teamcenter® software and NX™ software to further improve the process. Seamlessly linking the digital twin to advanced engineering analysis and the engineering bill-of-materials (eBOMs) gives the designer more freedom as well as a huge time advantage without the risk of losing data intelligence or overcomplicating the supply chain.

Electromagnetic simulation details of a traction drive

With this in mind, let's take a look at how to develop a traction drive. The specifications for the drive are for a North American Class IV delivery truck weighing 6,351 to 7,257 kilograms (kg). The European equivalent would be considered in the medium truck category.

Table 1: Traction drive specifications for a North American Class IV delivery truck.

| Performance requirement | Target |
|------------------------------------|-------------------------|
| Maximum/base speed | 6,000 RPM / 1,500 RPM |
| Continuous/peak output power | 100 kW / 200 kW |
| Maximum peak-to-peak torque ripple | 10 percent |
| Operating DC bus voltage | 400V – 650V (450V nom.) |
| Minimum efficiency at rated speed | 95 percent |
| Cooling type | Liquid (ethyl glycol) |
| Coolant temperature | 105°C |
| Coolant flow rate | 10 liters/min |

Let's look at a first potential design that is based on a permanent magnet in a synchronous reluctance motor that meets the above specifications. In this case, the model is created in Simcenter 3D software and is shown in figure 1.

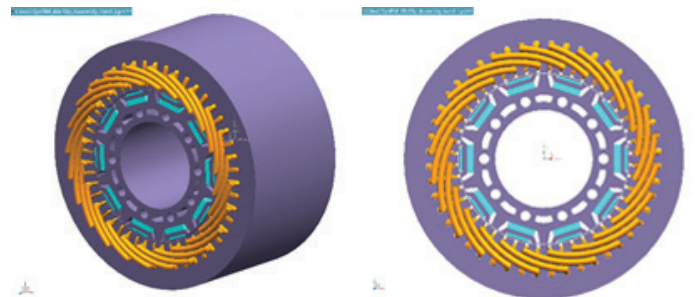

Figure 1: The first design possibility with a 48-slot and 10-pole option.

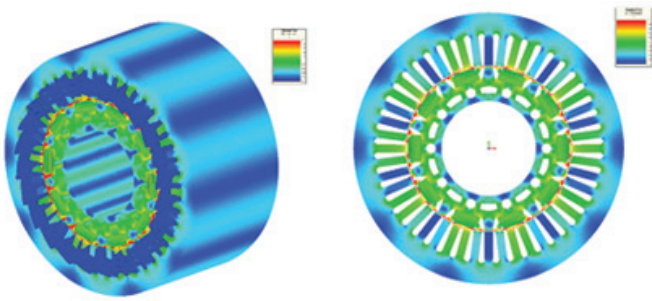

Figure 2: Flux density plot on the traction motor.

This design option features 48 slots and 10 poles. The resulting electromagnetic field solution is shown in figure 2 as a flux density plot. This is an excellent tool to help determine where material is being overused or where it is not needed and can be removed to save costs and reduce weight. Users can specify a minimum efficiency value for the operating range of the motor.

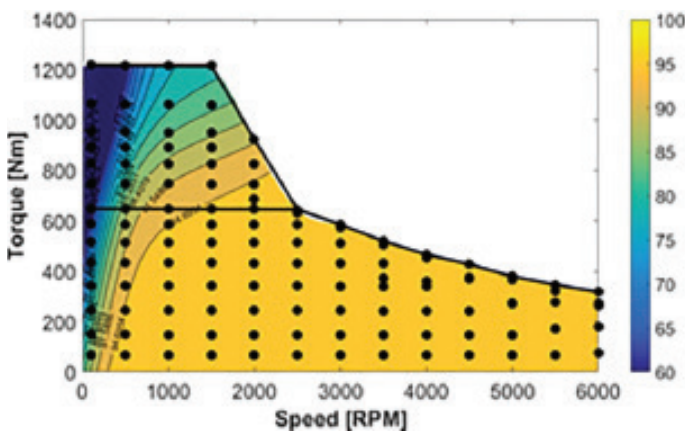

Figure 3: Efficiency map of the motor showing an operational efficiency range greater than 95 percent.

Looking at the resulting efficiency map shown in figure 3 above, users can see an accurate estimation of the losses calculated by the simulation. These include winding copper (resistive) losses as well as eddy current and hysteresis losses in the magnets and the iron components. After this step, the temperature rise in time increments can be determined by applying a time-dependent loss profile to the proposed cooling system. The temperature profile of the motor is developed from this, as shown below. It should be noted this run is loosely coupled since the time constants for the two systems are significantly different.

Figure 4(a) shows the temperatures of the main motor components versus time. Note that after about 2,250 minutes or about 37.5 hours of operation, the supply is

turned off and the motor begins to cool down. Figure 4(b) shows a possible demagnetization due to heat. From the simulation, it appears there is significant danger the outer permanent magnets could demagnetize if the motor runs at a slightly higher temperature than predicted. This is a vital piece of design information.

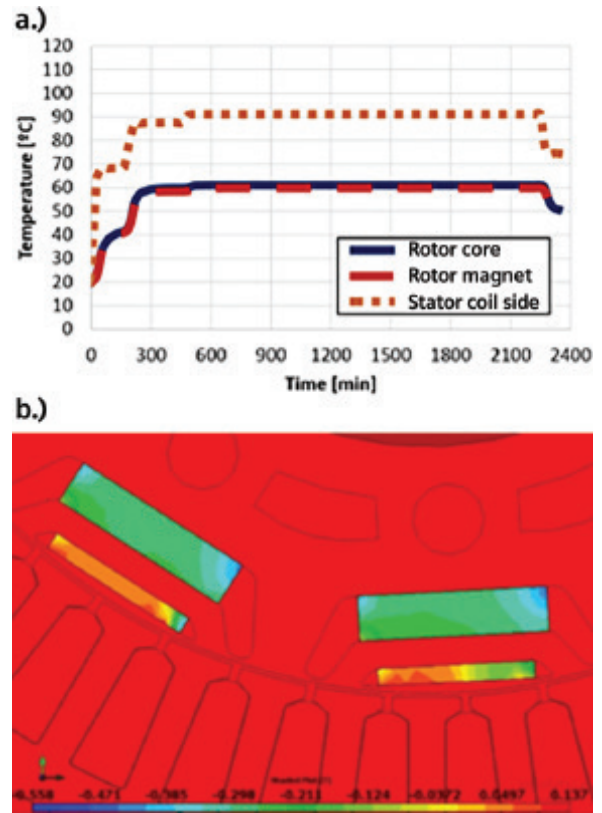

Figure 4: (a) The temperature profile of the motor components with time increments. (b) Demagnetization proximity for the permanent magnets. This shows the outer magnets in danger of demagnetization.

A final acoustic analysis is also possible to determine the noise level. This can be useful to determine the acoustic characteristics of the final product and if additional sound signatures might or might not need to be considered in the design phase. This part of the simulation requires a structural analysis of the stator to determine the resonant frequencies together with an air gap force waveform analysis. If the air gap force waveform includes harmonics that match the stator resonant frequencies, the motor could generate significant noise. Force harmonics depend on the operating mode and can vary significantly. To simulate this correctly requires a multiphysics approach, which links the electromagnetic performance to a structural analysis. The result is fed into an acoustic analysis system. The final values are

shown below in table 2 for three operating conditions of the motor. This step features a loosely coupled multi-physics analysis to simulate the machine. Adding this additional simulation step can provide a valuable piece of information early in the design process.

Table 2: Sound power levels in dB for three typical operation points for each motor design

| Operating point | FSCW | SynRM 1 | SynRM 2 |
|-------------------------------------|------|---------|---------|
| Continuous current at base speed | 78.1 | 76.2 | 74.4 |
| Peak current at base speed | 80.3 | 77.3 | 75.5 |
| Continuous current at maximum speed | 68.9 | 67.2 | 67.3 |

Actuators and other force-producing devices

Another area in which electromagnetic simulation is highly useful is the world of actuators. Actuators are like motors except the operation cycle is rarely continuous. The main job of this device is to generate on-demand output force to actuate a mechanical device. Two examples are shown in figure 5. Note the actuator can be operated in continuous mode. In this case, it would be considered a form of permanent magnet assisted switched reluctance machine (see figure 6).

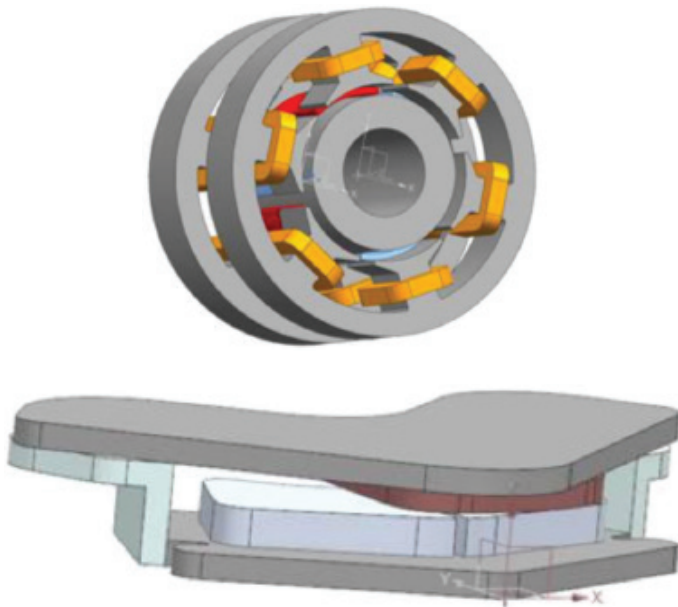

Figure 5: Two basic actuator systems.

Typically, actuators are used to open and close valves or other elements. They can control fluid flows in aircraft hydraulics or in a heating, ventilation and air conditioning (HVAC) system or instigate mechanical motion, like locking or unlocking car doors. Actuators are active in safety systems as well: Initiating airbag deployment is just one example of that. The main characteristic is an actuator does not function in a continuous mode. Unlike the traction drive we discussed previously, this means it is possible to increase the thermal rating of the system beyond what might be acceptable in a continuously operating electrical machine. However, the basic simulation requirements are similar, requiring coupled, multiphysics system simulation in which the electromagnetic field can interact with mechanical forces as well as thermal issues.



Figure 6: An example of a permanent magnet assisted switched reluctance machine using three actuator systems.

The connected society and electromagnetics

Today, connectivity has become second nature. Consumers expect high-quality connectivity all the time. This includes fast download speeds on portable devices with lower latency and low power consumption. The same holds true for all facets of industry communications, from communication between satellites and base stations, moving cars and infrastructure and robots and production line control stations, to name a few. With Industry 4.0 automation and a highly connected global society, the market for greater bandwidth, lower latency, better coverage and more power efficiency and sustainability across the communication grid will continue to boom for decades to come.

With this boom in global communication networks comes more EMI and EMC issues between communication devices, cables and electric wire harnesses. Both radiated and conducted power emissions will need

more attention, and there is no doubt properly engineering these high-level requirements will be a challenge. There are still quite a few methodologies and multidiscipline processes that need to be explored and tested. What we do know is handling low- and high-frequency electromagnetics correctly will require proper methodologies, tools and processes.

Both automotive and aerospace industries already have regulations for dealing with EMI/EMC issues and electromagnetic shielding is a quite common domain with a wide range of applications. But with the arrival of highly complex products and large-scale EV powertrains in transportation and heavy equipment, there are some areas that still need investigation. In the next section we will look at what the aerospace industry is doing with EMI/EMC and how digital twins can help during the design phase and provide support during certification.

A digital twin approach to support HIRF and IEL aircraft design and certification

We know today's airplanes are flying super computers with complex electronic systems and integrated communication and power systems that in most cases include new materials such as composites with reduced shielding effectiveness. Electromagnetics in the atmosphere, like lightning strikes, can cause interference and even damage the electrical systems, which in turn can compromise flight safety.

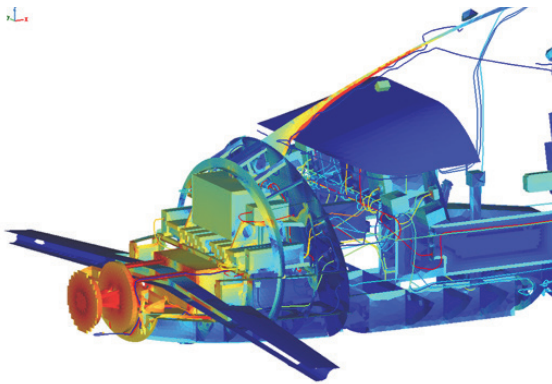

Figure 7: Currents induced by a lightning strike in internal parts and cables (courtesy of Piaggio Aerospace).

Therefore, indirect effects of lightning or IEL issues must be addressed early in the design process so an aircraft can be certified as specified by international regulators like the European Aviation Safety Agency (EASA) and Federal Aviation Administration (FAA). To reduce expensive and time-consuming late-stage testing, many players in the global aerospace industry are switching to a numerical modeling approach or digital twins to address these issues early in the design phase.

By integrating digital twins that can support electromagnetic simulation, engineers are able to account for indirect effects of lightning in the aircraft design. This in turn permits aerospace manufacturers to streamline the certification phases by demonstrating equipment performing safety-critical functions can withstand the transient current and voltage levels induced by any lightning flash configuration striking the aircraft. This happens at the cable level, which is why a hybrid Simcenter 3D Electromagnetic Multiconductor Transmission Line Network simulation and a corresponding interface to Capital™ software is required. In figure 8 below, regulators provide a clear scheme for certifying IEL compliance.

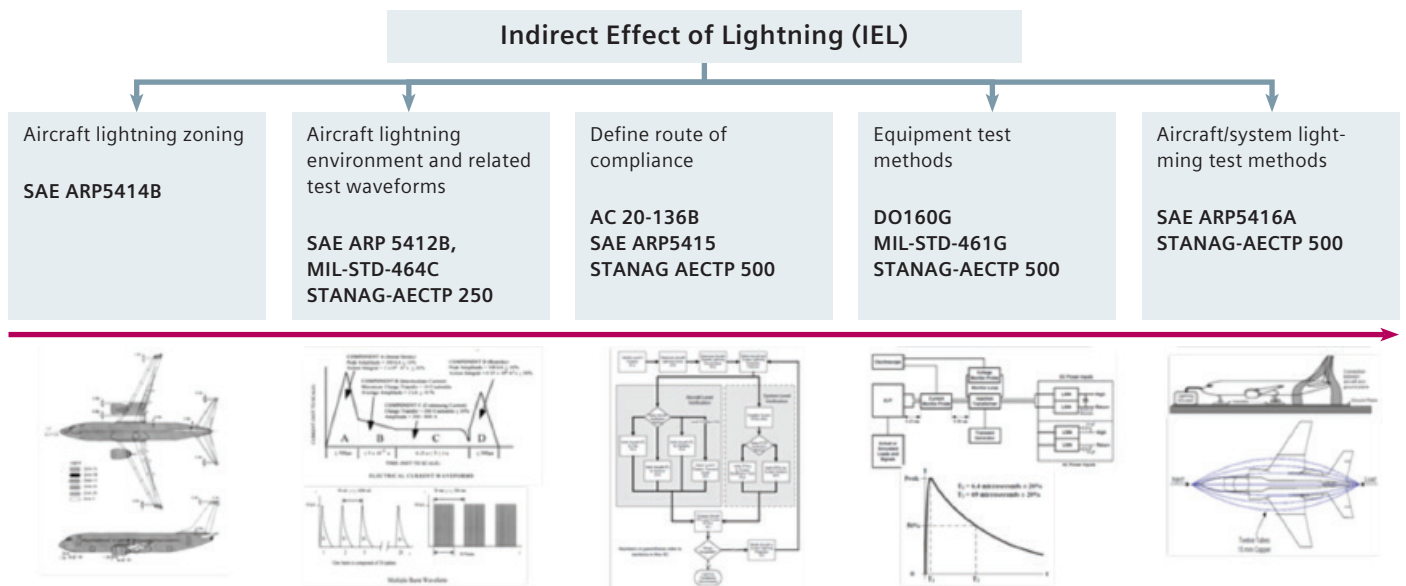

Figure 8: IEL regulations and the route to certifying compliance.

High-intensity radiated field regulations at a glance

Although lightning is one electromagnetic threat, electromagnetic interference generated from external radio frequency (RF) energy sources, like radio, television and radar emitters, is another. High intensity radiated fields (HIRF) issues, like external electromagnetic RF fields, can enter the aircraft structure through specific points, such as apertures, gaskets and composite materials with low shielding effectiveness, and may couple to cable harnesses or directly interfere with control equipment as shown in figure 9.

Therefore, the electromagnetic shielding properties of the structure are important factors to consider in the early design stages to demonstrate compliance with the HIRF certification process as shown in figure 10.

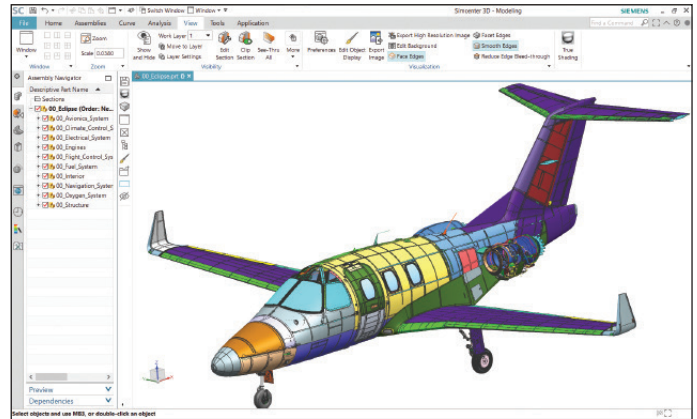

Figure 9: HIRF scenario.

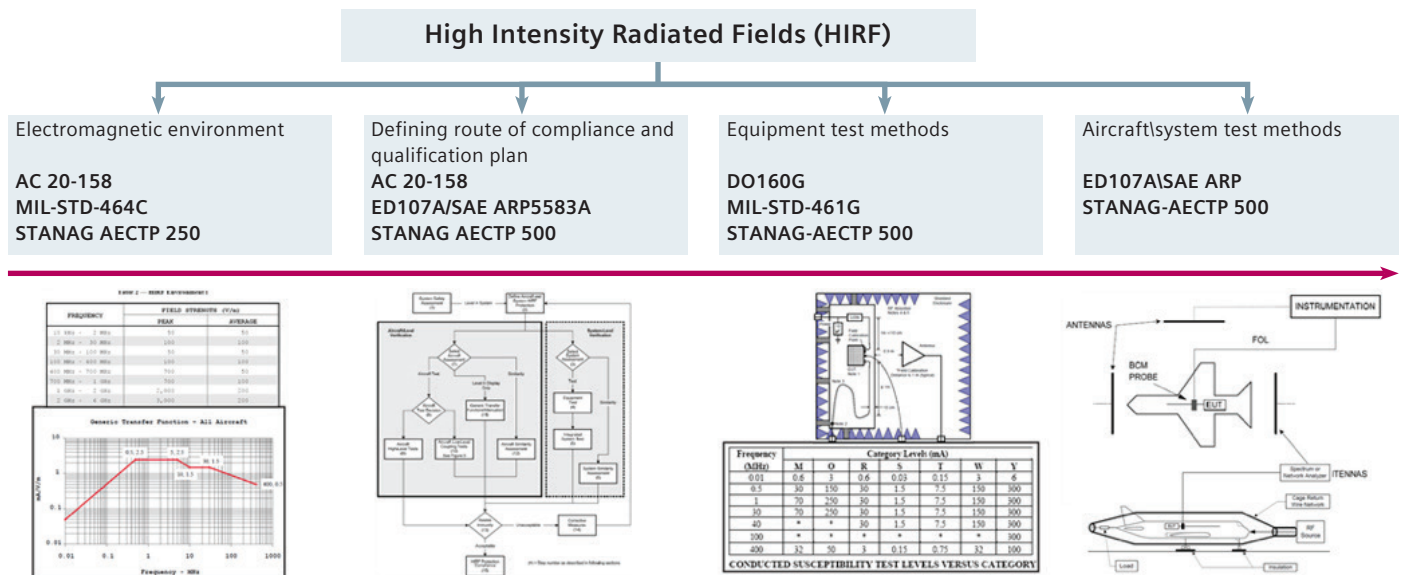

Figure 10: HIRF regulations and routes to certifying compliance.

A digital twin approach to support HIRF and IEL aircraft design and certification

The good news is certification authorities have recognized numerical analysis and simulation as an option to support IEL and HIRF compliance. Adapting a digital twin with electromagnetic simulation capabilities early in the process helps engineers evaluate HIRF and IEL issues well before having a physical prototype of the aircraft. This can prevent overdesign or inappropriate design of equipment, systems and aircraft HIRF and IEL protection shielding. Outside of the design phase, the validated digital twin can be used to effectively manage the design and certification of updated aircraft configurations. This validated digital twin provides preliminary computation

of physical parameters to properly drive physical testing both at the equipment and aircraft levels as well as offering full configuration control since it is embedded as part of the certification documentation and traceable within the computer-aided design (CAD) iterations.

In general, the digital twin process for IEL and HIRF certification compliance starts with a high-fidelity simulation model of the aircraft, known as a digital mock-up. This model is validated by a defined set of physical tests, setting the foundation for the certification phases (see figure 11 below). A compliance analysis plan needs to be prepared and approved by the various certification authorities prior to executing and achieving certification.

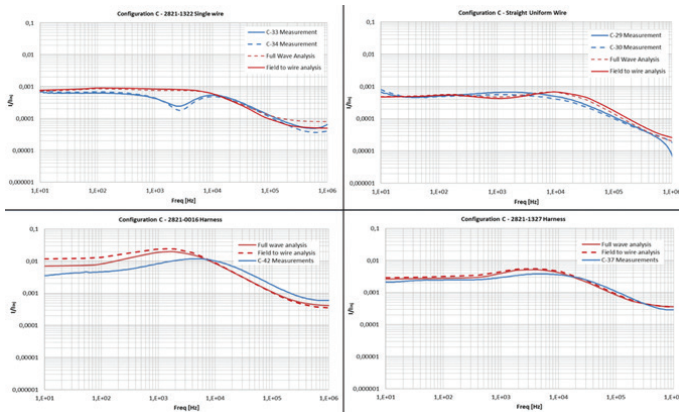

Figure 11: An aircraft fuselage mock-up for validating lightning tools showing normalized currents on some cables. The test plots show test measurement versus simulation. (courtesy of SAFRAN).

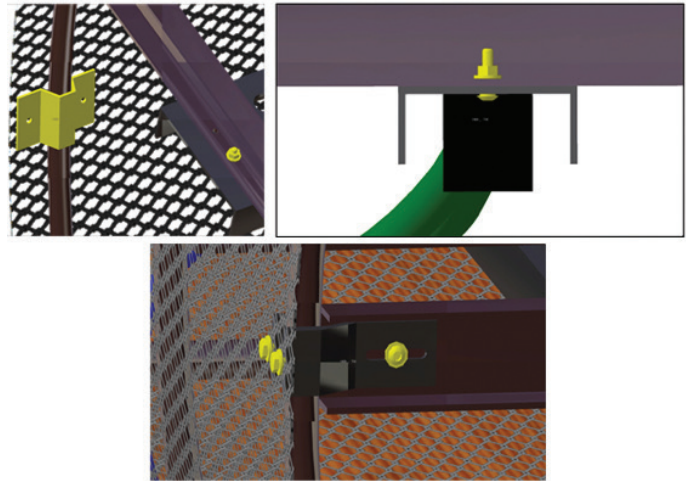

Figure 12: Modeling the smallest details to achieve the required accuracy.

Digital twin certification means the simulation needs to be highly accurate and account for electromagnetic performance across the spectrum from simple direct current applications to high-frequency scattering. It also includes a wide range of computed physical observations, such as bundle currents and electric field levels. To cover all this accurately, a multi-method approach is required. This simulation needs to be as complete as possible, which means modeling the smallest details, such as bonding and grounding contact resistances, apertures, seams and gaskets throughout the entire aircraft structure as shown below in figure 12.

This multiscale problem poses significant requirements for CAD processing capabilities. Just think about the computational challenge of generating and managing meshes composed of millions of elements and managing numerical ill-conditioning while accounting for software and hardware acceleration methods based on

iterative solvers, preconditioners and parallel coding. Therefore, what is required is a simulation suite with advanced and diverse computing capabilities and seamless interaction between CAD and computer-aided engineering (CAE) tools, like NX and Simcenter, for high-fidelity modeling and traceability without losing data intelligence as shown in figure 13.

But the challenges don't stop there, because having seamless and streamlined interfaces to electrical CAD tools is especially critical for electromagnetic simulation applications. For example, the digital twin needs to automatically import cable harness electrical CAD models, including the harness architectures and 3D routing, bundles composition, cables cross-section, cable jackets and braids, junctions and loading terminations, and translate them into models suitable for hybrid 3D electromagnetic Multiconductor Transmission Line Network

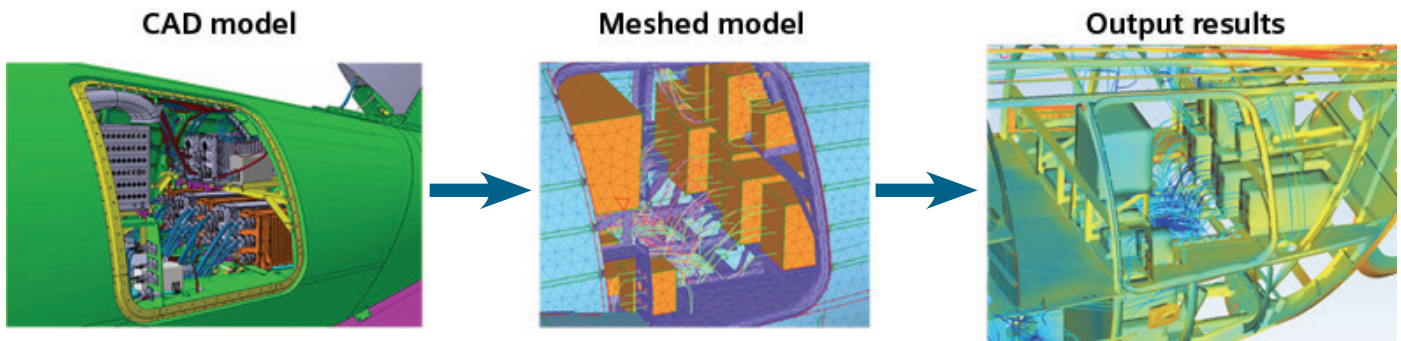

Figure 13: High fidelity modeling between the NX CAD and Simcenter CAE toolset.

simulation (see figure 14). Material modeling based on equivalent parameters, such as shielding effectiveness for penetration problems, surface impedance or transfer impedance for scattering/induced currents problems needs to be taken in account as well to reduce the complexity of the model to be certified (figure 15).

Here again, the Simcenter extended family can address issues on the electromagnetic front by working with additional software, like Capital, to manage the details

of electrical design and harness architecture as well as other issues on a platform scale.

When looking at this example, two key electromagnetic development elements have been addressed: complexity and scalability. By combining various Simcenter tools and electromagnetic usage levels, designers, engineers and system architects can create a workable and accurate digital twin that is seamlessly connected to a PLM backbone, such as Teamcenter.

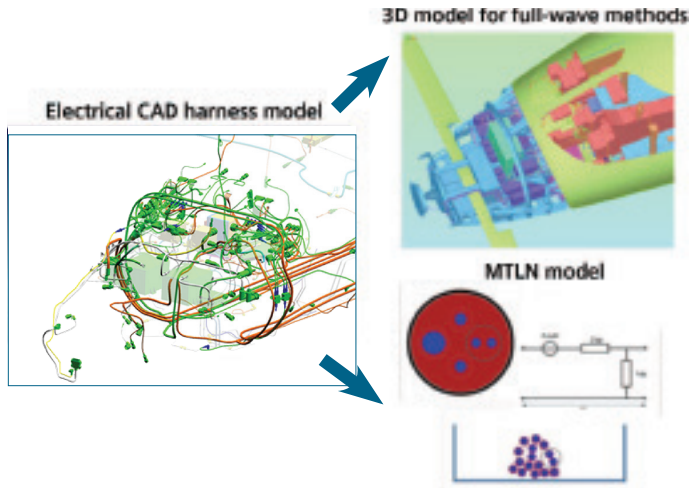

Figure 14: The seamless interface to electrical CAD model.

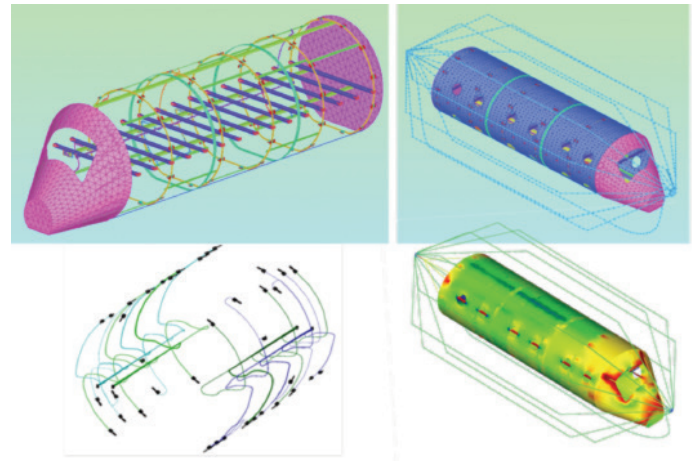

Figure 15: Aircraft fuselage mock-up for validating lightning tools: meshed model, harness and currents (courtesy of SAFRAN-Labinal).

Electromagnetics and advanced driving assistance systems

Remember we asked the question about sensors and rain at the beginning of this paper. Well, this links us nicely to another interesting electromagnetic case application: ADAS performance engineering and more specifically the electromagnetic effects of radar. Like the solution we discussed above, to accurately create complex digital twins requires the right combination of testing and simulation for verification and optimization purposes. Since we already covered quite a few of the details in our aerospace example, this application section will look at a couple of the highlights of ADAS engineering with an eye toward the future of mobility.

ADAS sensors based on radar technology are widely accepted as robust, effective and cost-efficient, and play an increasingly important role in passenger and pedestrian safety. With continuous pressure to engineer sensors that provide better performance, smaller size, greater robustness, including all weather conditions, it is critical to be able to engineer such solutions not only on the radar component level, but also on the vehicle level, including driving scenarios. Like other electromagnetic applications, high-fidelity simulation models and test measurements should support the entire design, development, optimization and verification cycle, starting from the standalone radar antenna performance up to verifying on-car installed radar operational performance.

Radar performance not only depends on the antenna, but also on the installation position. Radars are typically installed behind a bumper or grid that may affect performance. Antenna design is not enough to meet stringent vehicle safety norms and reduce the final verification tests. Assessing installed antenna performance and optimizing the installation position is mandatory.

Recent developments in electromagnetics simulation have enabled engineers to build high-fidelity numerical models of complex platforms, like digital mock-ups of an installed radar antenna. These models can be used to devise the optimal installation position, which is usually the location that minimizes radiation pattern distortion due to the interaction with the bumper or grid. In

addition, when the degrees-of-freedom (DOF) of the design permit, the bumper or grid shape, thickness and materials can be optimized to minimize the antenna pattern degradation and consequently enhance the overall radar performance.

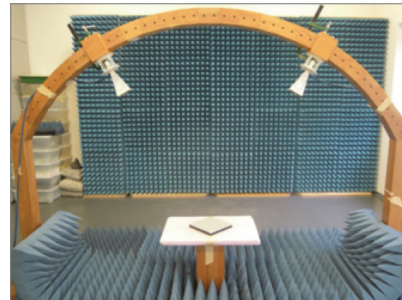

Figure 16: Example of measurement setup for material characterization.

Recently experts have taken this EM simulation a step further and accounted for moisture on the bumper, which could be attributed to rain. So, what happens to your car sensors when it is raining? A digital twin can provide some insight. It is possible to simulate what moisture does to your sensor. Figure 17 shows the comparison between the antenna gain with and without the water film deposited on the bumper. The gain has been reported instead of directivity to properly highlight losses due to the water film.

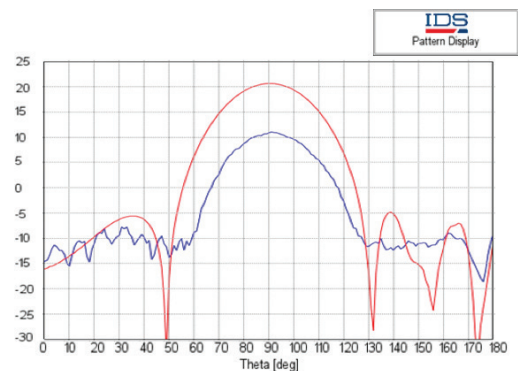

Figure 17: Effect at 24 GHz of water film deposited on the bumper external surface: comparison between antenna gain (blue) with and without (red) water film.

Figure 18 shows randomly distributed drops on a bumper and figure 19 displays electric and magnetic currents induced by the antenna on the external surface of the bumper. The effect of raindrops is more evident in magnetic current distribution.

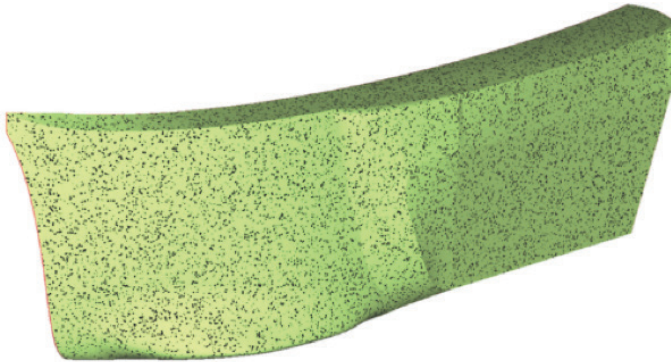

Figure 18: Randomly distributed rain drops on the bumper (black spots).

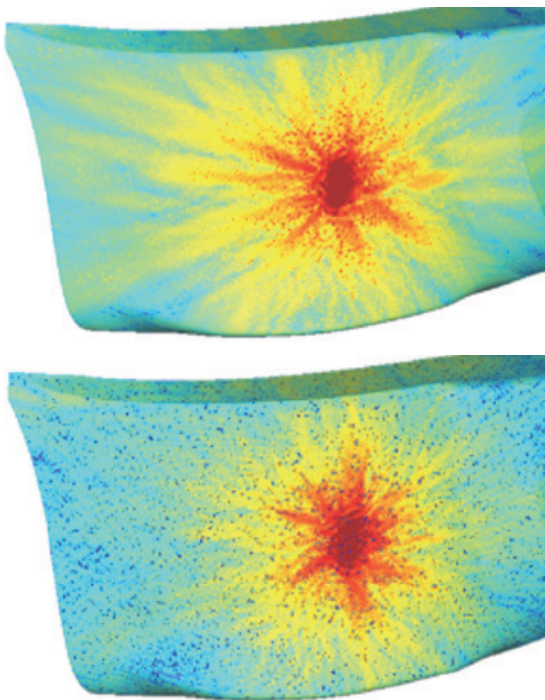

Figure 19: Electric (top) and magnetic (bottom).

From an electromagnetic point of view, it is worth noting the weather can have an impact on performance, which is not something that you would

normally think about when discussing electromagnetic simulation. The good news for experts is there are unique if not debatable ways of modeling meteorological effects for electromagnetic aspects of ADAS systems.

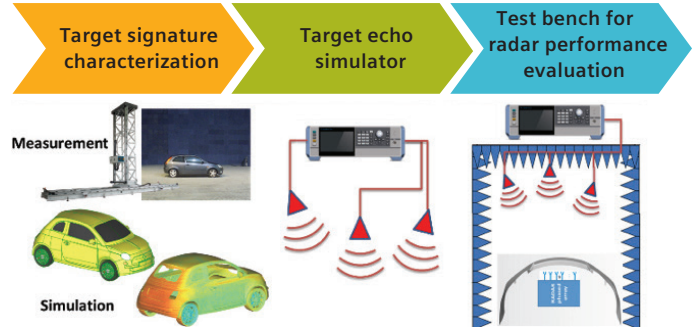

Figure 20: From target characterization to test bench for radar performance evaluation.

But how do you make sure your sensor is performing correctly? As we said previously, a simulation is not enough. Which is why the automotive industry counts on radar signature target characterization being performed both by measurement and simulation (see figure 20). In both cases it is worth noting some differences exist with respect to the more common radar cross-section (RCS) applications in the aeronautical area, because automotive target signature is a function of both aspect angle and distance from the radar. This also considers a multipath effect due to ground, near-field conditions (see figure 21).

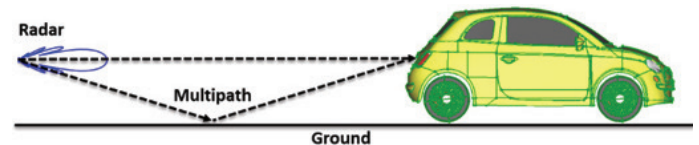

Figure 21: Multipath effect.

So there is also an aligned approach based on simulation and testing for ADAS radar performance engineering in which measurements are applied to provide input to the high-fidelity electromagnetic models developed in Simcenter 3D Electromagnetics. In reverse, the modeling results can be used to design and verify measurement setups, which in turn can enrich target echo databases for best-in-class optimization and faster verification.

Electronic circuits are everywhere – How to handle EMI/EMC issue

The last example deals with EMI/EMC issues with potentially susceptible electronic and radio frequency units, like those related to connected vehicles, infotainment and ADAS. Since our connected world will only get more connected, EMI/EMC assessment needs to be included when designing more complex vehicles. The fact interference couples directly to the cable harnesses complicates the EMC scenario because it distributes the EMI/EMC phenomena throughout the vehicle. Experts need to consider compatibility issues on the system level. In the frame of EVs and HEVs, these problems require specific attention because of the wide-band, high-level interference produced by the electric powertrain.

Electronic circuits are everywhere

Electronic circuits relevant to communication and infotainment systems, sensors, ADAS and high tech engine control units (ECUs) are making cars more complex. This doesn't even include what happens when the vehicle goes electric. HEVs and EVs potentially have a more severe internal environment for all this susceptible electronic equipment due to the presence of the inverter in the electric powertrain. In fact, the inverter, which is working at high power and fast switching frequency generating rapid voltage and current transients, is the major source of conducted and radiated electromagnetic noise.

The continuously increasing number of potential emitters and susceptible equipment installed in a limited space and the huge number of wires running along the chassis is posing serious electromagnetic compatibility issues. Consequently, more stringent EMC regulations and industry-standard testing procedures for homologating EVs and HEVs will become important. To answer these issues, specific modeling tools and regulator-acceptable processes must be devised to support automotive engineers during the early design phases to reduce the risk of failure in the final verification or certification phases.

In figures 22 and 23, we can see how using innovative, validated, 3D full-wave models can help overcome some of these challenges. The overall workflow is integrated into Simcenter for electromagnetics to assess potential EMI/EMC risks, define the most reasonable certification severity levels on the electronic subassembly level, and finally tradeoff possible technical solutions in the early design phase.

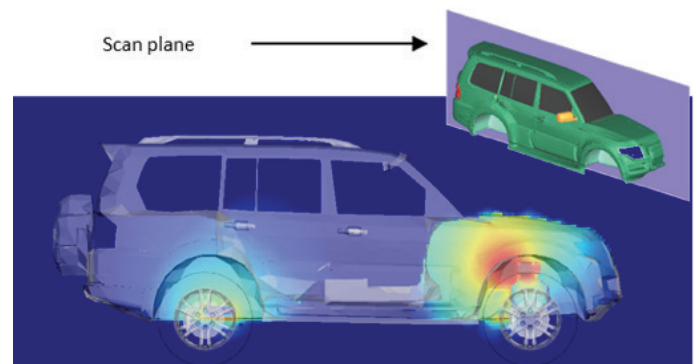

Figure 22: DC power bus: total radiated electric field distribution at 1MHz.

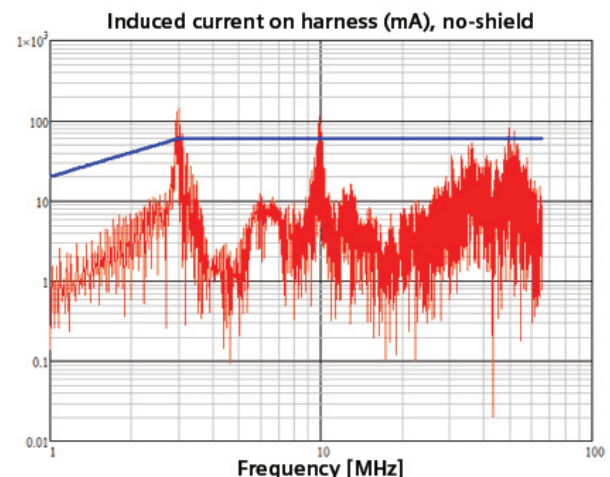

Figure 23: Detail of the induced currents in a harness on the wireless tire pressure sensor.

Conclusion

From the complexity of the traction drive to the relative simplicity of a basic actuator, the underlying toolset for electromagnetics analysis remains rather similar. Even when extended to some of the latest developments like digital twin driven certification for an airplane or assessing EMI/EMC issues in next-generation EVs and HEVs, managing electromagnetic engineering throughout the digital development cycle requires a broad, multifunctional and scalable toolset. The toolset should seamlessly transfer data from design to analysis to testing and final validation work without compromising the fidelity of the digital twin. This is the toolset you find with Simcenter for electromagnetics, part of the Simcenter simulation and testing portfolio. By being integrated in the engineering process, Simcenter for electromagnetics helps engineers create digital twins with the high fidelity required for safe, secure, connected and autonomous products.

This paper has discussed the need for an electromagnetic solution that includes design, simulation, analysis and testing tools. It has considered some classic

challenges in traction drives and actuators as well as more complex HIRF and IEL issues in airplanes, EMC/EMI problems related to HEV/EV powertrains and ADAS sensors and radars in automobiles.

In the automotive or aerospace market, we see a clear need for a broad, multifunctional toolset for electromagnetic engineering that can seamlessly link design and analysis digital twins throughout the development cycle. Once validated, these digital twins live on in PLM ecosystems and mobility chains, facilitating seamless product updates and autonomous driving database enhancements.

By using such a toolset, engineers can not only obtain a more optimal solution, but they can gain precious time compared to current processes. Taking a holistic approach with a multifunctional and broad toolset facilitates the seamless integration of electromagnetic applications into the overall design and development process. This results in more efficient, sustainable and better optimized products from complex airplanes and self-driving automobiles to connected consumer goods.

Siemens Digital Industries Software

Headquarters

Granite Park One
5800 Granite Parkway
Suite 600
Plano, TX 75024
USA
+1 972 987 3000

Americas

Granite Park One
5800 Granite Parkway
Suite 600
Plano, TX 75024
USA
+1 314 264 8499

Europe

Stephenson House
Sir William Siemens Square
Frimley, Camberley
Surrey, GU16 8QD
+44 (0) 1276 413200

Asia-Pacific

Unit 901-902, 9/F
Tower B, Manulife Financial Centre
223-231 Wai Yip Street, Kwun Tong
Kowloon, Hong Kong
+852 2230 3333

About Siemens Digital Industries Software

Siemens Digital Industries Software, a business unit of Siemens Digital Industries, is a leading global provider of software solutions to drive the digital transformation of industry, creating new opportunities for manufacturers to realize innovation. With headquarters in Plano, Texas, and over 140,000 customers worldwide, we work with companies of all sizes to transform the way ideas come to life, the way products are realized, and the way products and assets in operation are used and understood. For more information on our products and services, visit www.sw.siemens.com.

www.sw.siemens.com

© 2019 Siemens. A list of relevant Siemens trademarks can be found [here](#).
Other trademarks belong to their respective owners.

78154-C10 8/19 C