

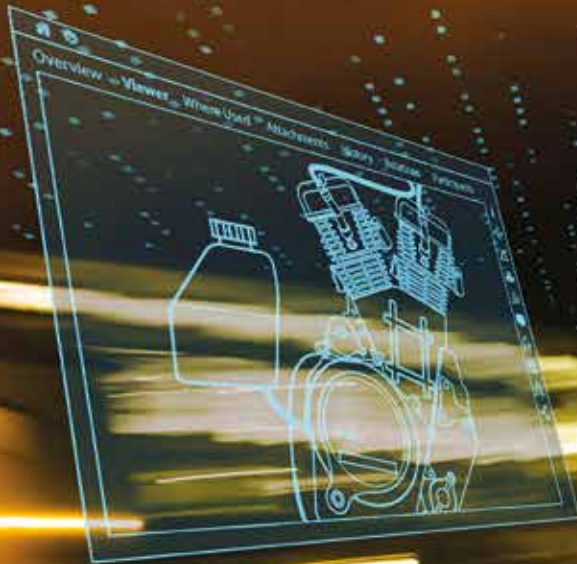

SIEMENS

Ingenuity for life



Siemens Digital Industries Software

Simcenter

Using the functional performance
digital twin to engineer innovation

[siemens.com/simcenter](https://www.siemens.com/simcenter)

Keeping up in a fast-changing world

Modern times have spoiled us in many ways. Thanks to industrialization, we live longer and more comfortably, enjoy the freedom of traveling around the globe and can communicate instantly with each other from practically anywhere. We take this new environment for granted, and as consumers, can act quite picky. This generates a competitive business environment for manufacturers, who we expect to fulfill our needs by delivering high-quality, smart products in a personalized form at a reasonable price when we need them. It leaves manufacturers little margin for error. Only the companies that can most effectively deal with this complexity will survive.

At the same time, our eagerness to consume puts enormous pressure on our environment, especially in combination with continuous population growth and globalization. This awareness is not new, but we seem to finally realize and agree as an international community that action is required before it is too late and irreparable damage is done to our planet. That is quite a game changer. The current generation will be the first in human history that has to carefully balance any technological advancement with its environmental impact. It will require huge engineering creativity to combine innovation with strict regulatory targets.

“We very much appreciate the collaboration with Siemens Digital Industries Software, especially the fully integrated service offered. It is not only about evaluating data; when needed, Siemens Digital Industries Software can provide us with the full line of services.”

*Dr. Christof Weber
Daimler Durability and Bench Testing
Competence Center
Daimler Trucks*

These challenges call for a transformation in how companies design and manufacture products, causing a business disruption on a scale we haven't witnessed in decades, with digitalization at the center of events. New, sometimes surprising players enter the market, companies shift activities and change business models, and established organizations are pressured to dramatically transform their processes in order to avoid losing market share. Digital technologies emerge everywhere to make products more efficient and smart, as well as to manage the design process and lifecycle. They have become indispensable to keep up in this fast-changing world.

This is where the Simcenter™ portfolio comes into play. With Simcenter, we help our customers avoid risk and gain a competitive edge by offering them a complete environment to effectively optimize the performance of complex products throughout the lifecycle, starting from the early stages. Simcenter allows engineers to generate a set of ultrarealistic, multi-physics models and data that can predict real product behavior. These are essential to the holistic digital twin, the industry paradigm that will help companies face today's challenges with smart designs that combine mechanics with software, electronics, controls and new, lightweight materials. Using Simcenter will help manufacturers engineer innovation into their products faster and with greater confidence.





“After three months of joint work with the Simcenter Engineering team aimed at defining a step-by-step real-time methodology to achieve desired performance, the fuel specialists have been convinced and the decision has been made to extend this approach to all fuel models. Using Simcenter Amesim and Simcenter Engineering we reduced the fuel system design cycle by a year.”

*Franck Nicolas
Head of Simulation and
Tools
Airbus Helicopters*

Discover the power of digitalization

New, smart products will be self-learning and continuously updated based on use data or operating conditions to better or more effectively serve the user. That will alter how manufacturers stay connected to every single product, and how they should engage with customers. After delivery, they will have to make sure performance keeps meeting all design requirements, and react when necessary. Product development should never stop before end-of-life, which requires bi-directional and efficient information exchange between the engineering team and each individual product.

To facilitate this, most manufacturers will need to radically transform their processes. They will have to digitally capture and connect all lifecycle phases, from ideation, when the product is designed and performance assessed, to realization, when it is manufactured, to utilization. This new approach will grant them instant access to more accurate data at any time.

The ultimate degree of such digitalization is a holistic digital twin. The digital twin consists of continuously evolving, ultrarealistic individual product descriptions that take shape during the early development stages, when bringing together initial subsystem models to make architectural choices and engineers refine and complete the design. Then it stays in sync with its physical counterpart through the lifecycle, keeping track of all possible parameter changes, including manufacturing-related deviations, modifications, uncertainties, updates, wear and maintenance history.

Deploying such a concept, or at least working toward it, will be indispensable to stay in business. But the advantages are myriad. Faster and more realistic simulations will help engineering teams predict true product behavior, and be far more successful when dealing with multi-physics complexity. Digital representations of both the manufacturing plant and process will dramatically increase productivity, safety and precision, and facilitate logistics. And closing the loop between utilization and design will bring more than user-based feedback or continued optimization. Having up-to-date simulation models that can run in real-time will enable manufacturers to include predictive capabilities in products. These could ultimately allow autonomous functioning.

Simcenter includes all the necessary capabilities to plug performance engineering into the holistic digital twin. By providing a comprehensive offering for simulation and testing, Simcenter delivers accuracy and efficiency, which is intended to let traditional verification-centric development processes evolve into the predictive approach of the digital twin. By linking to Teamcenter® software, Simcenter connects ideation and utilization. Simcenter is designed for improved efficiency, reduced development time and increased market agility in order to help companies engineer innovation better and faster and at lower cost.

Performance engineering 2.0

“Since our group adopted the practice of combining HEEDS software with simulation two years ago, the strategic value that we can provide to the Becton Dickinson product development community has accelerated dramatically.”

Anita Bestelmeyer
Director of CAE
Becton Dickinson

The vision of a holistic digital twin is gaining ground throughout industries. To remain relevant in this new context, various performance engineering aspects will need to mature. Both manufacturers and software suppliers will have to do their share to make that happen.

Especially with increasingly complex products, designs and decisions should be evaluated with more realistic models. Current practices should evolve in many areas, such as coupling multiple physics and disciplines, providing more accurate modeling techniques, accommodating larger simulations and faster solvers, delivering real-time capabilities and including real data in hybrid models. This will provide greater confidence in simulation and test data and make them available in a timely manner, which will be essential for achieving less overdesign, reducing the need for end-of-cycle tests, lowering the risk of field failures, reducing development time and enhancing cost savings.

Secondly, companies will also have to remove classic barriers between departments and promote enterprise-wide collaboration to let performance engineering be active in the digital twin. People, projects and data need to be better connected so decisions can result from a process that involves all stakeholders based on an instantly available holistic view. This should be accomplished with better management, sharing and linking of processes, models and data, improved documentation, automated workflows and traceability of requirements over the entire engineering cycle.

Furthermore, decision-making should be supported by more powerful tools that can intelligently and automatically explore the design space to help engineers quickly understand design drivers and tradeoffs. With hundreds of design variants, it's vital to have high-quality analytics and visualization capabilities that deliver insight. These make simulations useable and accessible, and actively point to the best possible design.

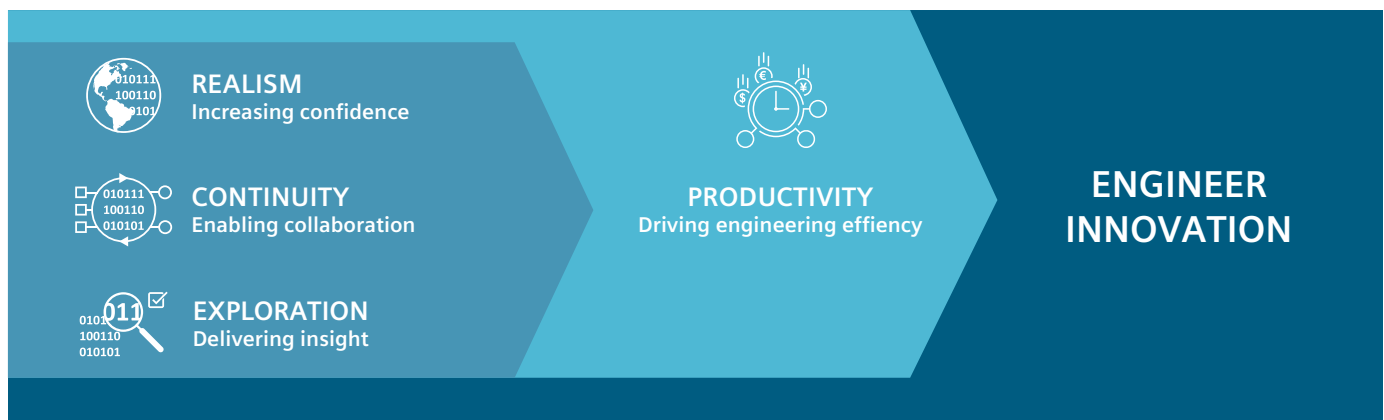

Ultimately, improved realism, connectivity and exploration should result in higher productivity. A digital twin must deliver insights in time to influence decisions. Therefore, it will be crucial that all performance engineering aspects are supported by consistent interfaces and efficient processes in streamlined and automated workflows, as well as powerful computing resources. Deploying a comprehensive platform throughout the organization that brings all these aspects together and ensures a consistent user experience across domains will allow companies to save lots of time they can use to engineer innovation.

These focus areas have led us to bring all these state-of-the-art simulation and testing technologies together under the Simcenter umbrella. With Simcenter, we want to set the next standard for performance engineering, a vision that we are consolidating in tangible development plans, both for individual applications as well as for the overall platform.

"I think Simcenter Engineering has three main differentiators. Firstly, they combine high-end testing with CAE. Secondly, they have vast experience with automotive OEMs. And finally, Simcenter Engineering has a very talented global team of experts."

*Hitoshi Kyogoku
Vehicle Dynamics CAE Group
Manager
Nissan Motor Company*



Delivering a comprehensive solutions portfolio

The strength of Simcenter is in both the excellence of its individual components and the synergies that can be achieved by combining them. The physical testing, multi-disciplinary computer-aided engineering (CAE), computational fluid dynamics (CFD) and powerful multi-physics system simulation solutions are long-time industry leading applications. Simcenter solutions merge those elements with robust design exploration and data analytics, which are managed in a product lifecycle management (PLM) context powered by Teamcenter.

This alignment of applications helps engineers generate ultrarealistic models much more effectively; for example, by enabling constant interaction between test and simulation, facilitating multi-physics modeling (including controls), or by allowing the inclusion of operational data at any time.

The Simcenter portfolio has the breadth and quality to let performance engineering support the holistic digital twin.

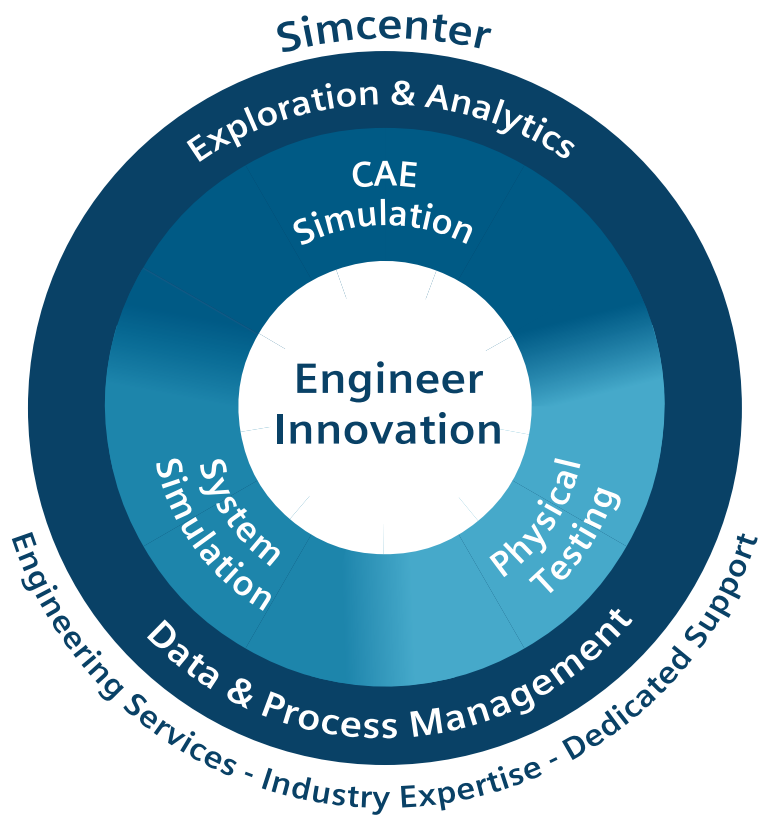



SYSTEM SIMULATION

Predict multi-domain system performance at the concept stage using system simulation. Simcenter includes a large set of predefined physical and application libraries so you can effectively build realistic models that can also be used for co-simulation with CAE and control strategy validation.

CAE SIMULATION

Simulate the real-world performance of geometry based designs. Simcenter CAE/CFD solutions combine effective preprocessing, a large variety of powerful multi-physics and multidisciplinary solvers as well as application-specific postprocessing in efficient simulation processes with embedded industry expertise, providing better insight into product behavior.

PHYSICAL TESTING

Employ physical testing systems to achieve accurate simulations and effective component and final product validation. Simcenter testing solutions offer a complete, integrated environment for test-based engineering.

DESIGN EXPLORATION

Accelerate performance predictions and design modification decisions. Simcenter includes an efficient and easy-to-use multidisciplinary exploration framework that easily integrates with existing design and simulation tools, and fully leverages the available high-performance computing infrastructure.

SIMULATION DATA MANAGEMENT

Effectively manage and share complex simulation data. Simcenter seamlessly integrates with Teamcenter. This solution keeps analysis models and results in sync throughout the product lifecycle. By capturing and managing data and processes, companies can build long-term knowledge and value.

ENGINEERING AND CONSULTING SERVICES

Engage with a scalable, versatile and talented team of engineering experts. At Simcenter, companies can expand their capabilities, solve problems and realize the digitalization journey. Simcenter specialists assist customers in addressing complex challenges and safeguarding the balance between design options and functional performance.

Mastering engineering complexity

“Simcenter Amesim has proven to be very useful, enabling us to better predict performance and enlarge the validation scope of the design at an early stage. We are very happy that it exists.”

*Christian Bénac
Head of Modeling and
Simulation Deployment
Airbus*

Successful design of complex mechatronic products requires a scalable multi-physics system simulation platform that allows engineers to determine how all functional performance requirements can best be met, starting from the early stages. This will help them benchmark multiple design options as well as balance and optimize conflicting performance aspects earlier so that they can discover the best designs in the most efficient way.

Simcenter includes solutions that help system simulation engineers quickly yet accurately predict multi-physics behavior throughout the development cycle, from the beginning until final validation and controls calibration.

Simcenter Amesim

Simcenter Amesim™ software is an integrated, scalable platform that saves engineers significant modeling time by allowing them draw upon over 6,500 ready-to-use components in multi-physics libraries. These have been developed and validated in collaboration with industrial partners. Further, engineers can benefit from finding application-oriented solutions tailored to industries such as automotive, aerospace, industrial machinery, heavy equipment, energy and marine.

Thanks to the powerful platform capabilities of Simcenter Amesim, engineers can perform rapid and accurate analysis. This is complemented by a large time and frequency domain plotting features and 2D and 3D animations for better insights into the dynamic behavior of systems, as well as integrated design exploration tools for optimization and design of experiments (DOE).

The software also includes linear analysis capabilities, which engineers can use to study mechanical couplings, or to investigate dynamic system behavior with limited central processing unit (CPU) time on reduced models. It also enables you to generate customized applications; for example, to import parameters from Excel spreadsheet software or data files, automate simulations or launch postprocessing scripts, analyze simulation results, generate plots and make reports.

Simcenter Amesim is also an open environment that can be integrated with available enterprise processes. The software can easily be coupled with major CAE, computer-aided design (CAD) and controls software packages, interoperate with the Functional Mockup Interfaces (FMIs) and connect to other Simcenter solutions as well as Teamcenter.

Manufacturers that deploy Simcenter Amesim as part of their standard development process will achieve accelerated design cycles, reduced development costs and superior products that excite their customers.



Benefits

- Faster and earlier assessment of complex system behavior
- Increased simulation accuracy by capturing all physics in the mechatronic system
- Earlier benchmarking of design options and balancing of conflicting performance attributes
- Increased simulation productivity by using best-in-class technologies
- Improved collaboration between teams by sharing a platform for system and controls modeling

Accelerating design using system simulation

Simcenter System Synthesis

Using Simcenter helps simulation architects and project engineers accelerate the design cycle by allowing them to quickly and accurately generate complex co-simulation models. Using Simcenter System Synthesis enables them to build heterogeneous system simulation architectures and seamlessly evaluate performance. This solution lets physical plant and controls engineers collaborate more effectively through a common modeling language based on interfaces. Further, it greatly reduces modeling effort by keeping simulation models traceable and re-usable for other purposes.

Simcenter Embedded Software Designer

Simcenter helps engineers design embedded software more effectively and avoids rework by frontloading error detection. The Simcenter Embedded Software Designer solution facilitates an architecture-centric approach to define, enrich, simulate and analyze onboard software designs.

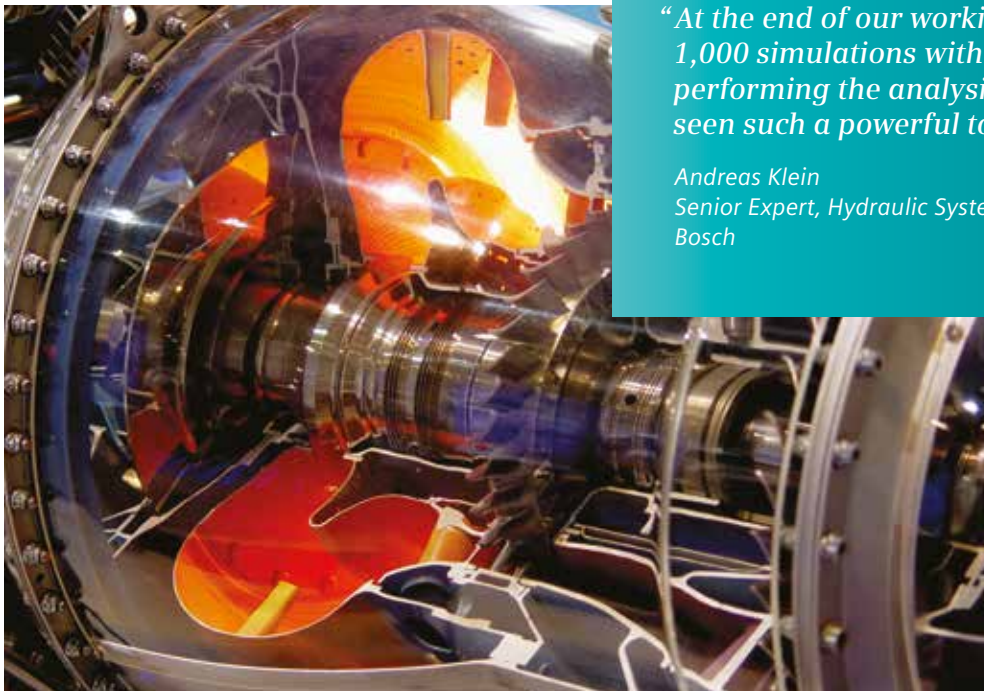

“At the end of our working day, we launch about 1,000 simulations with Simcenter Amesim performing the analysis at night. I have never seen such a powerful tool.”

*Andreas Klein
Senior Expert, Hydraulic System Simulation
Bosch*



Simcenter Embedded Software Designer can be used to implement onboard software designs in external development environments thanks to its template-based export functions. The solution's contract-based architecture drives testing, verification and closed-loop simulation, and is interoperable with other Simcenter solutions as well as with Polarion™ ALM software. This provides digital continuity when dealing with scattered processes and tool landscapes.

Simcenter Webapp Server

Using Simcenter Webapp Server greatly simplifies the mechatronic systems engineering workflow. This solution helps to extend the use of system simulation throughout the company as it supports project engineers with system integration activities and offers technical sales staff direct access to performance evaluation of complex products. The Simcenter Webapp Server features web-based access and predefined system model parameterization in custom graphical user interfaces (GUIs).



“If you are interested in the global parameters of the system, a 1D simulation tool such as Simcenter Amesim, is the best option because it is fast, reliable and easy to use.”

Gabriele Pastrello
 R&D Engineering
 RONCHI MARIO

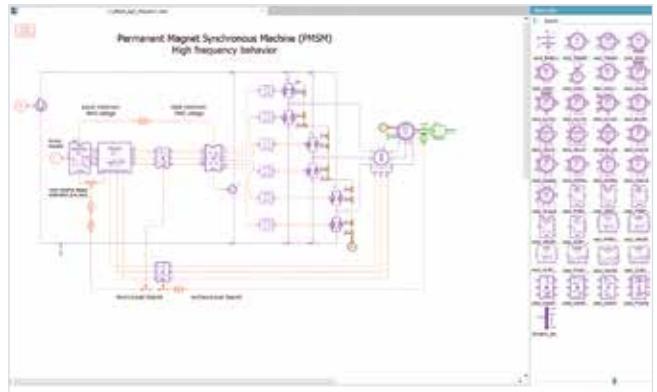

Dedicated system simulation for specific systems

Simcenter Prescan

Simcenter includes a physics-based simulation platform for the development and validation of advanced driver assistance systems (ADAS) and active safety systems. Using Simcenter Prescan™ software, engineers can design ADAS based on sensor technologies such as radar, laser/lidar, camera and Geographical Positioning system (GPS). Simcenter Prescan can also be used to design and evaluate both vehicle-to-vehicle (V2V) and vehicle-to-infrastructure (V2I) communication applications, as well as autonomous driving capabilities. Engineers can use Simcenter Prescan from model-based controller design in model-in-the-loop (MiL) simulations to real-time tests in software-in-the-Loop (SiL) and hardware-in-the-loop (HiL) simulations.

Simcenter Flomaster

Simcenter can help engineers model and analyze fluid mechanics in complex piping systems of any scale using 1D CFD. By using Simcenter Flomaster™ software, they can simulate pressure surge, temperature and fluid flow rates along the system, and quickly yet accurately understand how design changes, component size, selection and operational conditions will affect overall fluid system performance.

Companies can integrate Simcenter Flomaster during any stage of the development process, and benefit from its data management and collaborative capabilities. The software helps manufacturers in various industries save time and cost when designing thermofluid systems.

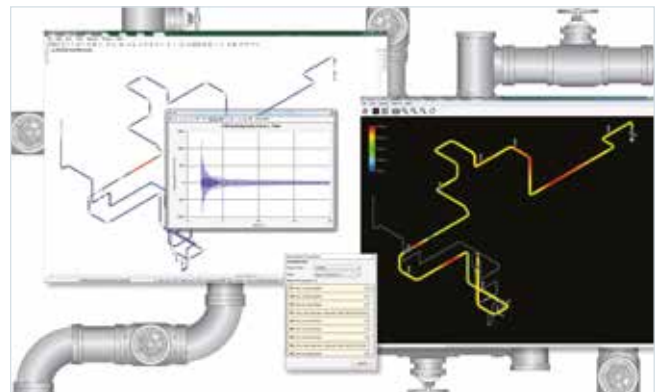
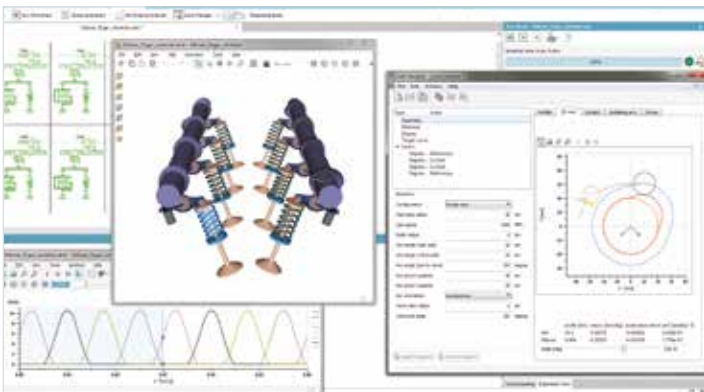

Boosting CAE simulation efficiency

“A model with 1 million degrees of freedom can be meshed in only 10 minutes.”

Lu Xianglin
Deputy Manager
Guangxi Yuchai
Machinery

Within the digital twin context, it will be crucial for performance engineering to have tools that combine excellence with efficiency. On one hand, specialists require dedicated CAE capabilities to accurately simulate individual design aspects. At the same time, they need these solutions to be fast and have all the various applications in an integrated environment so that they can effectively find the right balance in case there are conflicting requirement targets.

Simcenter offers engineering teams a unified, shared platform for CAE simulation for multiple performance disciplines, including structural and acoustics, noise, vibration and harshness (NVH), flow, thermal, motion, durability and composites analyses, as well as optimization and multi-physics simulation. This solution streamlines performance engineering processes and delivers revolutionary improvements in CAE simulation efficiency.

Simcenter 3D

Simcenter 3D Software offers leading-edge analysis tools that are easy-to-use, incorporates more productive workflows and generates consistent results. The solution is scalable, open and extensible, with connections to design and 1D system simulation, including co-simulation to study the performance of complex systems; test, including hybrid modeling capabilities for increased simulation accuracy, and data management. It combines highly accurate solvers that are based on decades of industry expertise with best-in-class geometry editing and intuitive, associative simulation modeling.

The software has excellent geometry manipulation tools that can handle CAD data from any source to reduce the time spent on model abstraction. Then Simcenter 3D lets engineers prepare finite element (FE) and motion models from a centralized hub with comprehensive meshing and modeling capabilities that support multiple simulation applications. Geometry edits/abstractions, meshes, loads and boundary conditions are all associated with the base design, which means when the design topology changes, engineers can rapidly update their model, re-simulate and get results much faster than they can with traditional CAE tools.

Being a comprehensive platform, Simcenter 3D avoids the use of disconnected tools and dramatically reduces the time that is wasted on translating data between CAD and CAE as well as between different CAE tools. It provides designers and product stakeholders better and earlier access to accurate simulation results so that they can make informed decisions that drive development.

Simcenter 3D also easily connects to external data sources and supports popular third-party solvers in addition to its own. Seamless integration with Teamcenter helps companies more easily manage simulation data and facilitates collaboration between CAE analysts and design teams. Finally, the software can help to increase efficiency by capturing the knowledge and expertise of the simulation team through a robust set of application programming interfaces (APIs) to automate simulation workflows.

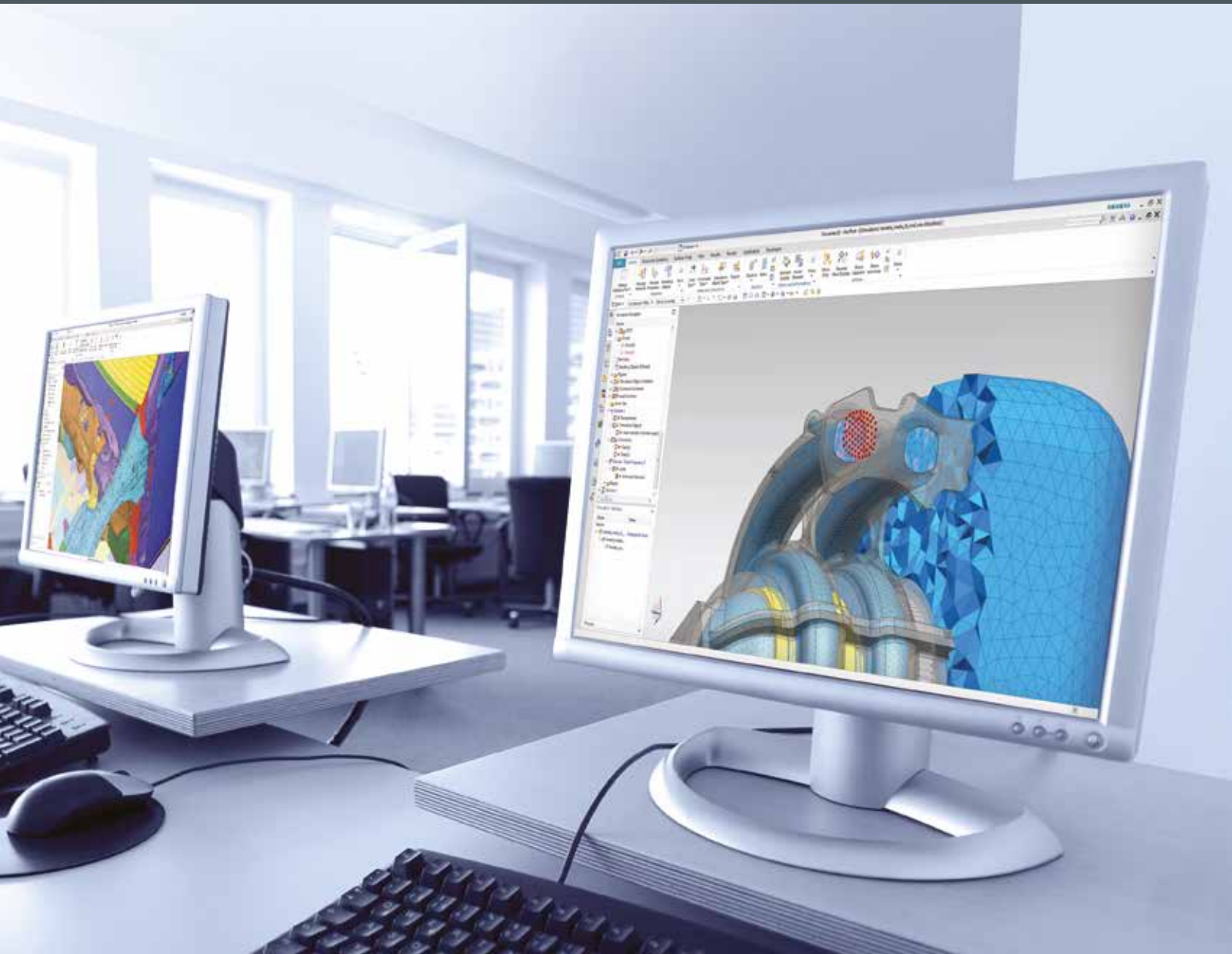

Benefits

- Timely insights to drive design decisions
- Accurate product performance prediction
- Integrated and streamlined workflows that accelerate the simulation process
- Increased simulation team flexibility and throughput
- Provides better visibility into product performance to the broader decision-making enterprise

Leveraging decades of industry expertise

NX Nastran

Simcenter includes the premier finite element method (FEM) solver NX™ Nastran® software to offer engineers computational performance, accuracy, reliability and scalability. NX Nastran includes powerful solutions for linear and nonlinear structural analysis, dynamic response, acoustics, rotor dynamics, aeroelasticity, thermal analysis and optimization. Having all these solutions in a single solver greatly simplifies modeling processes as input/output file formats are the same for all solution types. NX Nastran is available as a standalone enterprise solver, or as an integrated solver in Simcenter 3D.

Simcenter Samcef

Simcenter also offers the Simcenter Samcef FEM solver suite for simulating critical performance aspects of mechanical systems. The high-quality and powerful Simcenter Samcef solutions are particularly suitable for nonlinear FEM and multibody simulation. The software also includes dedicated technologies for specific applications, such as wind turbine development, rotor dynamics, structural and thermal analysis, composite analysis and more.

“Simcenter 3D helps us dramatically reduce product cost and lead time, while increasing quality.”

*Vivien Cheng
Head, Product Development Department
Samsonite*

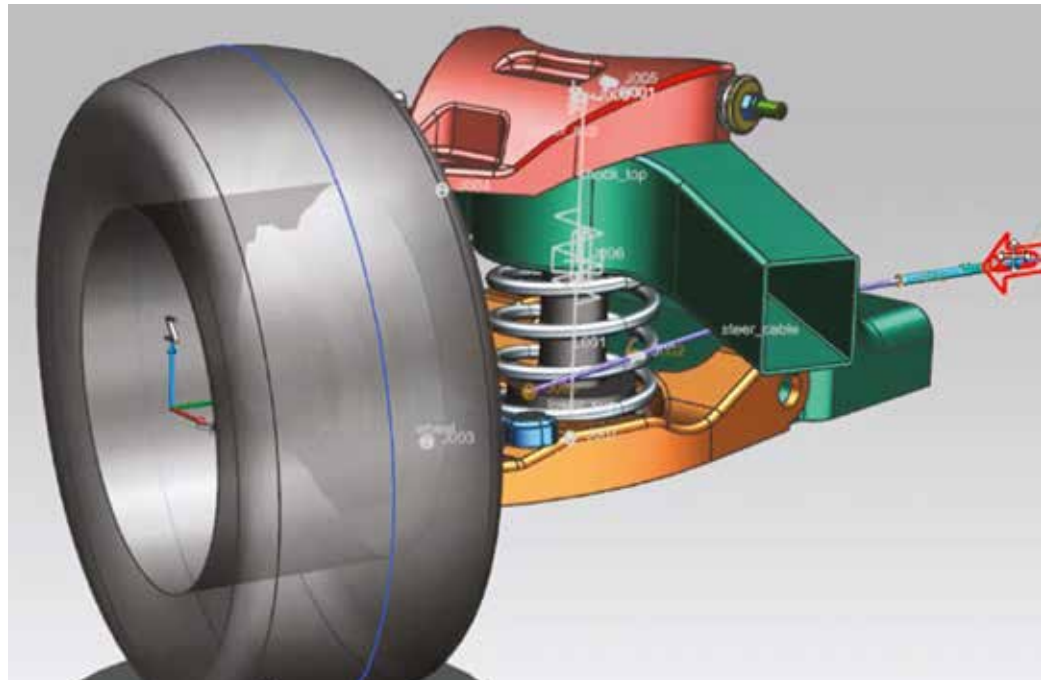

Femap

In Simcenter, engineers can find Femap™ software. This solution allows them to create, edit, import/re-use mesh-centric FEM models of complex products, as well as visualize and evaluate results in a powerful way. Femap can be combined with a wide variety of CAD systems and FEM solvers, including NX Nastran, to deliver a comprehensive CAE solution that helps make sure components, assemblies, or complete products perform as designed in real-world environments.

Simcenter Madymo

Simcenter can help vehicle manufacturers reduce the time spent in building and testing prototypes for safety purposes, and minimize the risk for late design changes. By using Simcenter Madymo™ software, researchers and engineers can model, analyze and optimize vehicles for occupant safety early in the development process. In Simcenter Madymo, engineers can include active human models in their analysis. In these next-generation models, spine joint restraints and muscles combine passive stiffness characteristics with active control in order to realistically represent responses of human beings.

“In the past, it took us about one year from concept to production, and today we have cut that down to three or four months.”

*Anna-Gret Borchert
Calculation Engineer
AMAZONE*

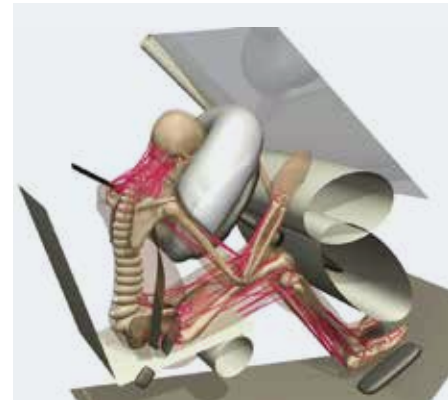
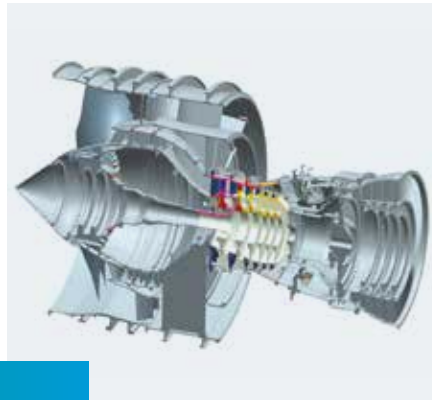

“Many finite element modeling packages don’t handle assemblies very well, but Simcenter 3D does.”

*Ramesh Krishnan
Senior Staff Engineer
Orbital ATK*

An integrated multi-physics solution for CFD engineers

“Together, Simcenter STAR-CCM+ and Simcenter Amesim help us optimize designs and deliver innovation faster.”

*Norbert Bulten,
General Manager
Hydrodynamics
Wärtsilä*

Solving complex industrial problems requires CFD simulation tools that span a variety of physics to reduce uncertainty and overengineering. Only multi-physics simulation can capture all the relevant physics to properly predict how a product will behave in real-world conditions. Multi-physics simulation has to be powerful, yet efficient so that it can be deployed early and often in the product development cycle and automatically drive design improvements.

Simcenter provides a robust multi-physics engineering solution for CFD engineers, built for the simplest to the most advanced simulation needs. It uniquely integrates comprehensive physics with intelligent design exploration in a single CAD-to-solution environment to accurately predict product performance and get the necessary insight to guide product design from start to finish.

Simcenter STAR-CCM+

Using Simcenter STAR-CCM+™ software, all steps in the simulation process are accessed from a single integrated environment that hosts the geometry, mesh, physics models and results. This ensures that every simulation has been part of a robust and consistent workflow that can be replayed for updating models with minimal effort. Once an engineer has created a simulation, it can be easily re-used to investigate a full range of design configurations and operating scenarios.

Much more than a CFD solver, Simcenter STAR-CCM+ is a comprehensive simulation tool that delivers a broad range of physics models in a single integrated environment. This eliminates the need to learn and connect multiple tools and allows physical phenomena to be studied in a fully coupled manner, reducing approximation and increasing confidence in design decisions. The validated physics models in Simcenter STAR-CCM+ include: fluid dynamics, solid mechanics, electromagnetics, heat transfer, multiphase flow, particle dynamics, reacting flow, electrochemistry, aeroacoustics and rheology.

Simcenter STAR-CCM+ offers intelligent design exploration built directly into the engineer's familiar simulation workflow, leveraging its automated meshing, pipelined workflow and accurate physics to overcome the complexities that have historically prevented CFD simulation from being used this way. This eases the transition from running single-point simulations to analyzing hundreds of design variants to find tradeoffs in design.

As computing power continues to grow exponentially and becomes more affordable, Simcenter STAR-CCM+ has been developed with scalability in mind. It is parallelized from meshing to solution, and it scales to hundreds of thousands of cores, far beyond the computing power of most industrial users. This allows engineers to push the boundaries of their high-fidelity CFD simulations, from solving single large-scale analyses to intelligently exploring the design space.

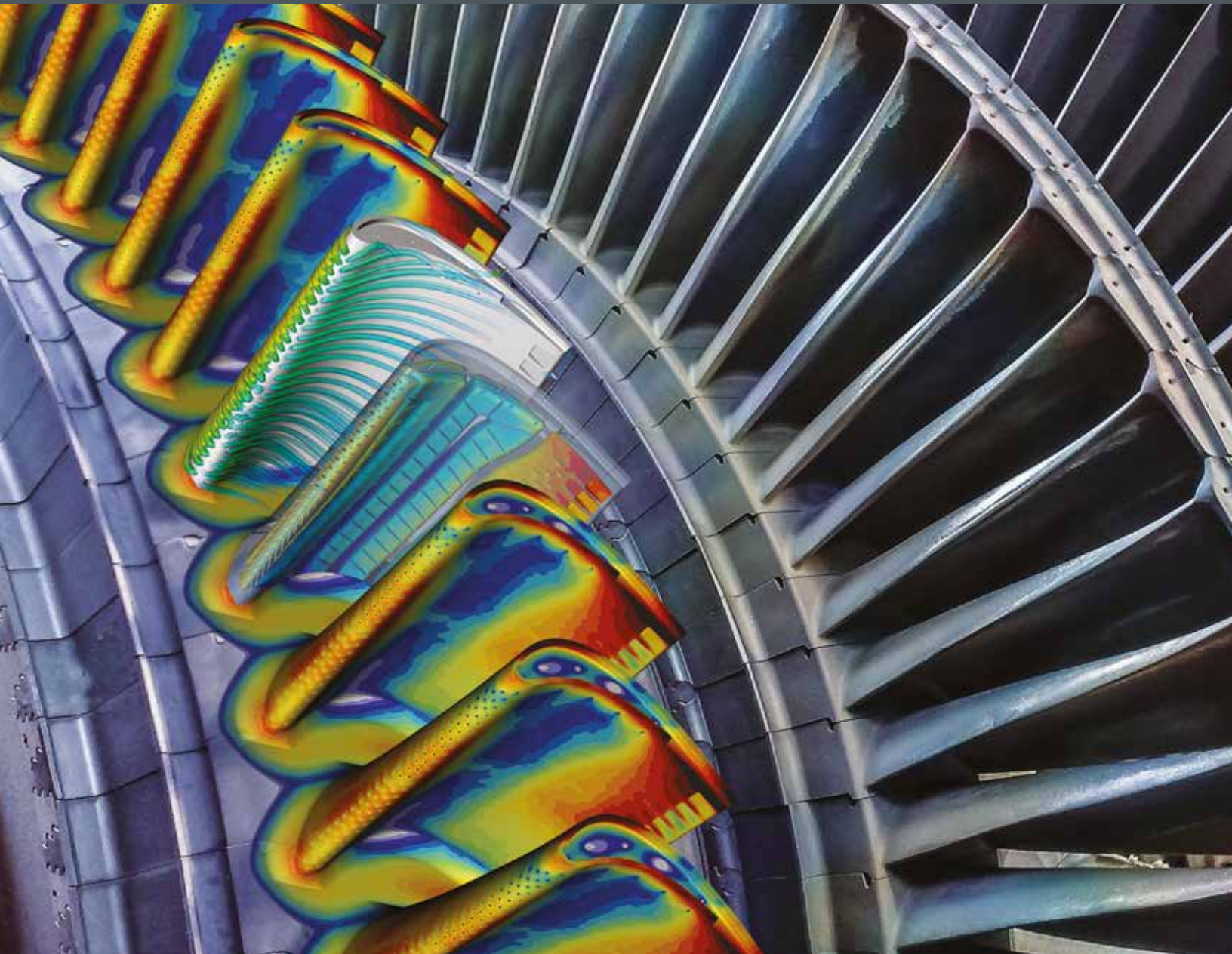

Benefits

- Faster design improvement using intelligent design exploration
- Reduced development time and cost by deploying simulation frequently during the design cycle
- Increased productivity thanks to robust and automated workflows
- Provide better insights by simulating real-world performance
- High-performance computing to solve even the most complex industrial problems, including multi-physics

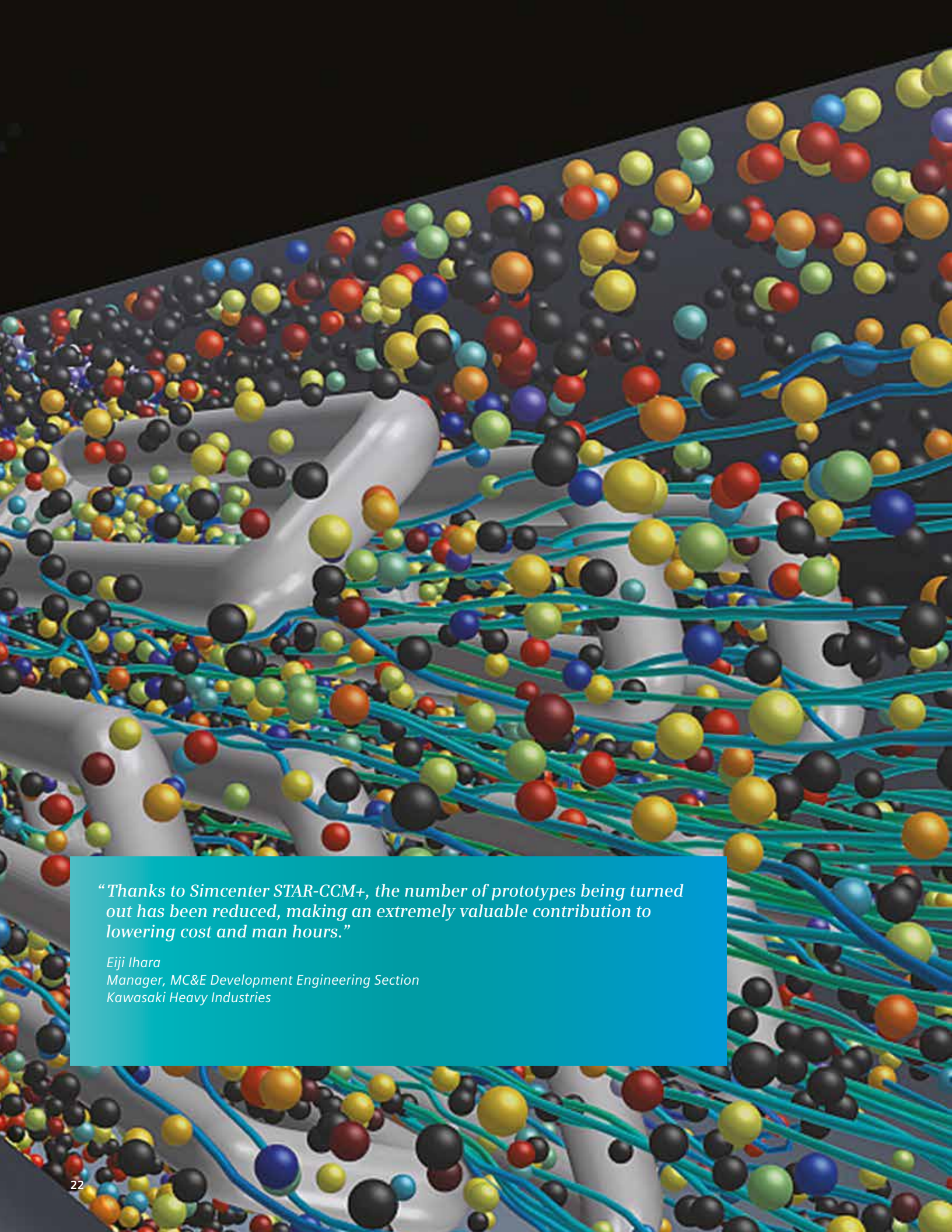

“Thanks to Simcenter STAR-CCM+, the number of prototypes being turned out has been reduced, making an extremely valuable contribution to lowering cost and man hours.”

*Eiji Ihara
Manager, MC&E Development Engineering Section
Kawasaki Heavy Industries*

Providing CFD solutions for specific applications

STAR-CD

Simcenter includes a leading CFD solution for engine design that incorporates all the required models to accurately predict the air flow, fuel mixing and combustion that take place in internal combustion engines.

STAR-CD® software allows automotive manufacturers to integrate upfront simulation in the product design process to address the tough challenges of reconciling legislative and market demands. With STAR-CD, most of the world's largest engine manufacturers investigate new engine technologies, such as downsizing, water injection and multi-injection strategies.

Simcenter FLOEFD

Simcenter helps design engineers perform upfront, concurrent CFD analysis using their familiar CAD interface. Frontloading CFD calculations dramatically reduces the simulation time, and allows earlier optimization of product performance and reliability. This decreases physical prototyping and development costs by reducing time or material penalties.

Simcenter FLOEFD™ software is fully embedded in leading CAD systems, allowing concurrent design simulation and reducing design times by orders of magnitude compared to traditional methods. The solution comes with full-featured 3D fluid flow and heat transfer analysis.

Simcenter Flotherm

Simcenter helps companies save design time for electronics, including components, boards, complete systems and data centers. By using the Simcenter Flotherm™ software 3D CFD suite, engineers can predict the air flow and heat transfer in and around electronic equipment.

Simcenter Flotherm is interoperable with Simcenter T3STER™ and DYNTIM for the import of measurement-based thermal models. The software also closely integrates with mechanical computer-aided design (MCAD) software and native equipment data acquisition (EDA) interfaces. With Simcenter Flotherm, engineers can count on fast meshing and solution technologies to keep pace with design changes.

Enabling multi-physics simulations for dedicated applications

Battery Design Studio

Simcenter includes a dedicated simulation environment for rapid analysis and design of individual lithium ion battery (LIB) cells to improve their performance and reliability.

Using Battery Design Studio™ software, engineers can digitalize the design of a LIB cell with fine geometric control over each cell part. The design can be simulated with a range of cell performance models to quickly improve the operational behavior in simple to complex duty cycles. Battery Design Studio speeds up the LIB design process with a design-oriented interface and platform that connects material suppliers, cell designers and battery users.

Simcenter SPEED

Simcenter includes a dedicated simulation environment for the design and analysis of electric machines to reduce cost and size as well as increase lifetime and reliability.

Simcenter SPEED offers engineers intuitive and efficient capabilities for sizing and preliminary design of common electric machines, such as synchronous, induction, switched reluctance, brushed permanent magnet, axial flux and wound field commutator motors. The design can be rapidly simulated with an analytical solver to assess its behavior in simple to complex duty cycles, or it can be analyzed more rigorously using 2D finite element analysis (FEA).

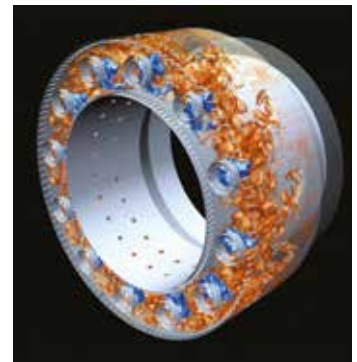
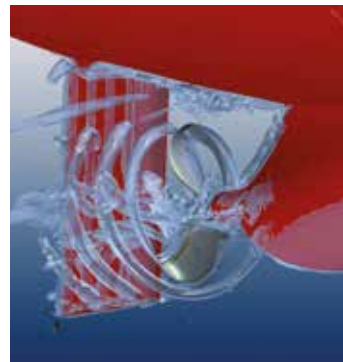
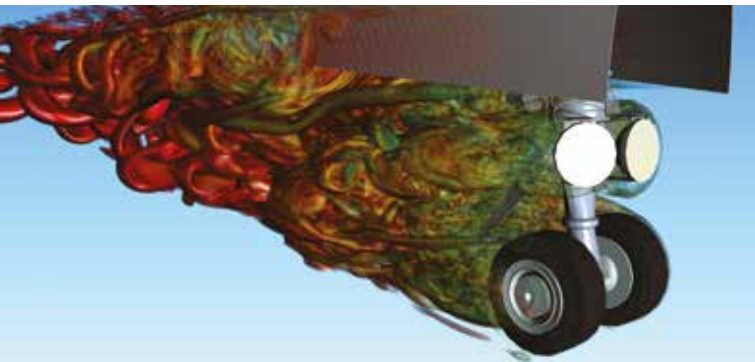

“Our simulation workflow with Simcenter STAR-CCM+ delivered a 70 percent reduction in engineering time.”

Mark Dekker
Lead Aerodynamic Engineer
KLK Motorsport

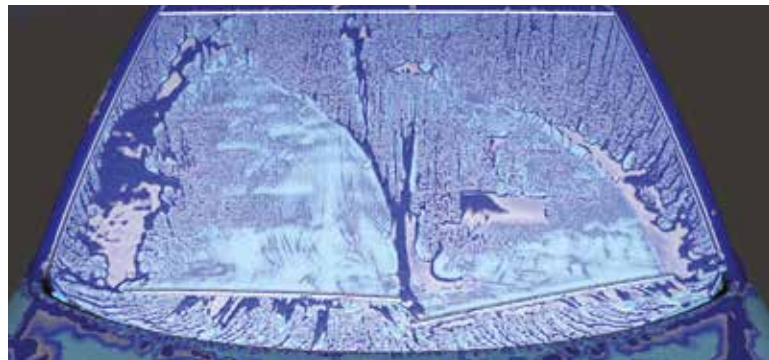

Simcenter MAGNET

Simcenter can help engineers accurately simulate the design of motors, sensors, transformers, actuators, solenoids or any component with permanent magnets or coils. Using Simcenter MAGNET™ software, they can quickly explore multiple configurations and get insight into performance. This faster and better design will reduce costs.

Simcenter MAGNET can offer both 2D and 3D electromagnetic field simulation within the same user-friendly interface. Engineers can find magnetostatic, frequency dependent (AC) and time-varying solutions, and can include the effects of moving components.

Simcenter Motorsolve

Simcenter allows engineers to effectively design and analyze induction, synchronous and electronically and brush-commutated machines.

Simcenter Motorsolve™ uses equivalent circuit calculations and a unique automated FEA engine to simulate machine performance. The solution saves engineers a lot of time by avoiding the need to conduct typical FEM operations, such as mesh refinements and postprocessing. The template-based interface is easy to use and sufficiently flexible to handle practically any motor topology.

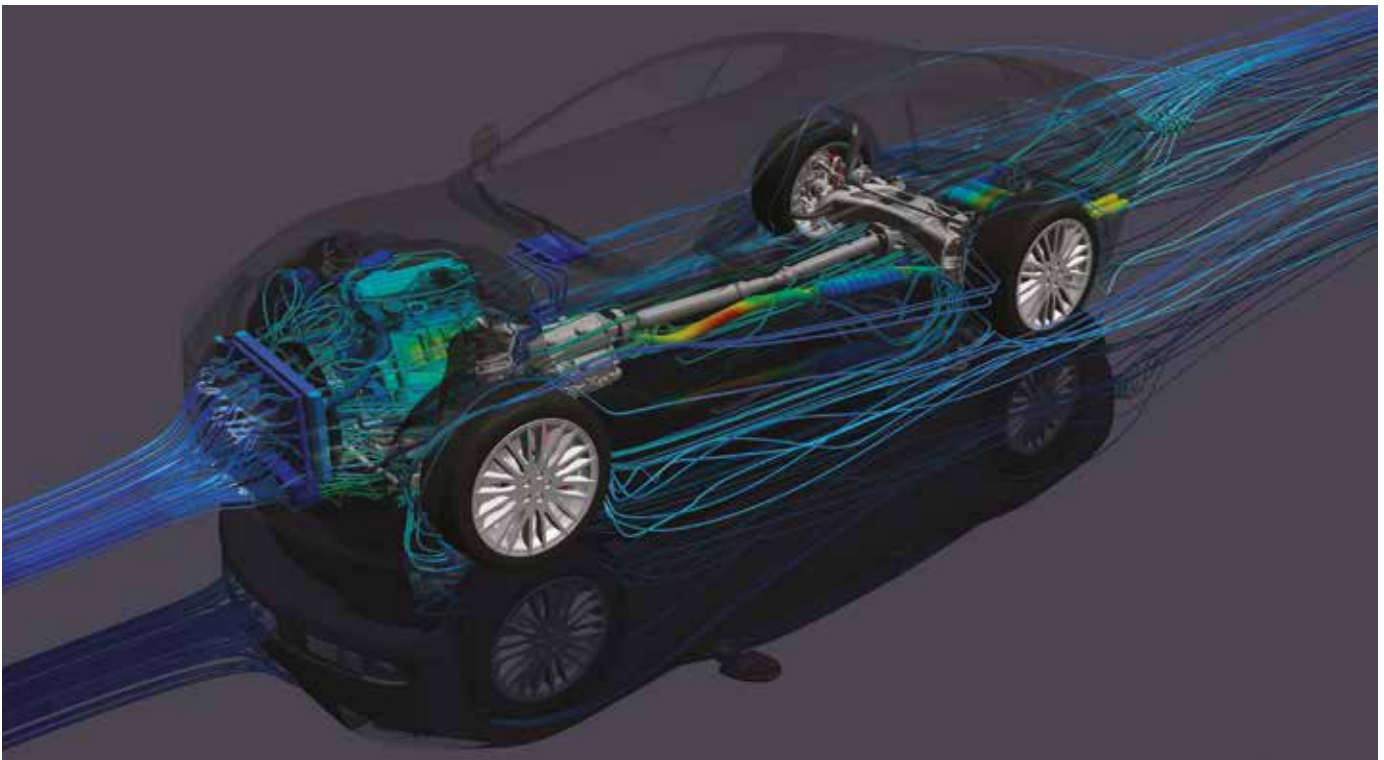

Increasing productivity in physical testing engineers

“Simcenter Testlab offers an integrated end-to-end solution for load data acquisition and processing. The solution accelerates the delivery of critical durability insights when preparing for test rig campaigns or reliable simulations. It is faster, easier to use and robust.”

Guillermo Gonzalez
Function and Durability
Manager
Nissan Technical Center
Europe

Using Simcenter helps testing departments handle the exploding amount of validation work that comes with increasing product complexity and mass customization. In spite of the rising prominence of digital technologies, certification testing of physical prototypes will remain a crucial part of the product launch. On top of that, many additional test applications will become vital to support simulation of aspects such as new materials, complex components and multi-physics, and achieve a more realistic digital twin.

Simcenter testing solutions help engineers test, validate and optimize real-world designs within the constraints of shorter testing cycles, conflicting performance requirements, growing product complexity and reduced costs. These solutions tightly integrate multi-physics data acquisition hardware with a complete suite of acquisition, analytics and modeling software to cover a wide range of test needs in the core fields of acoustics, vibrations and durability.

Simcenter Testlab

Simcenter Testlab™ software is a complete, integrated solution for test-based engineering. It is designed to make individual users and complete teams more efficient. As the amount of data from physical and virtual testing campaigns continuously grows, it is vital to organize and track it. With Simcenter Testlab, team members swiftly convert, visualize, interpret, compare, analyze, report and share data with solutions that include specific application knowledge. Simcenter Testlab is ideal for leading-edge testing departments. It offers the right balance between ease-of-use and engineering flexibility, and closes the loop with simulation. The software can be used to significantly increase a test facility's productivity, delivering more reliable results even when the availability of prototypes is dramatically reduced.

Latest releases of Simcenter Testlab include Simcenter Testlab Neo software. This next-generation testing platform integrates decades of engineering experience into an environment that offers greater productivity, more insights, increased confidence and easier collaboration. Simcenter Testlab Neo offers a new task-driven user experience, suitable for both the novice and expert. A fully customizable and flexible process designer speeds up analysis, supports multidisciplinary analytics and accepts simulation models as part of any process flow. Selectable display panels as well as intuitive and interactive graphs accelerate interpretation of results.

Simcenter Testlab delivers critical insights to innovate smart products, increase testing productivity and efficiency, maintain quality, enhance team collaboration and engineering flexibility, close the loop with simulation and lower the cost of ownership.

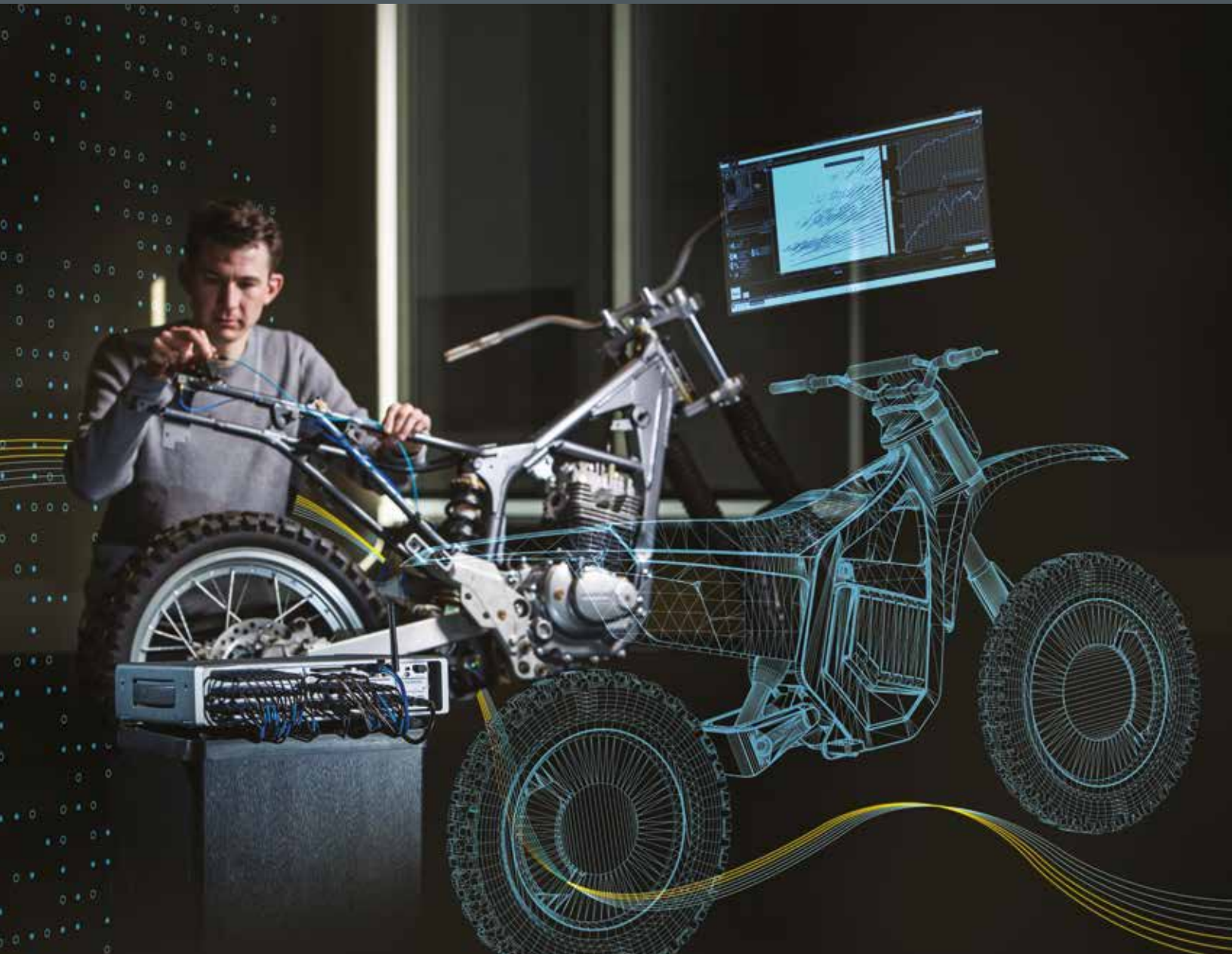

Benefits

- Increased testing productivity with enhanced ease-of-use in automated or easily customizable processes
- More insight thanks to multi-physics data collection and analytics
- Higher confidence in data quality and results validity
- Easier collaboration between departments with easy data sharing, unified interfaces and compelling reports
- Boosted return-on-investment (ROI) using flexible and scalable solutions and value-based licensing options

Powerful hardware for a wide variety of testing applications

The range of Simcenter testing hardware and software is fit for many industry applications, and offers multi-physics testing on a unified platform, covering acoustic testing, transfer path analysis (TPA), structural dynamics testing, rotating machinery testing, durability testing, dynamic environmental testing and model-based system testing.

The powerful Simcenter data acquisition hardware and sound source localization (SSL) solutions are designed to help engineers set up and carry out tests faster and more efficiently than ever.

Simcenter SCADAS

Simcenter SCADAS™ hardware includes hand-held solutions, compact and portable mobile units, autonomous smart recorders and high-channel-count laboratory data acquisition systems to get the testing job done right the first time, whether it is in the lab, on the track or in the field. Its flexibility, performance and precision make it an excellent choice for a wide range of multi-physics measurement applications.

Any Simcenter SCADAS system can include a large variety of analog and digital transducers to optimally support acoustic, vibration and durability engineering; and it seamlessly integrates with Simcenter Testlab for accelerated test setup and correctly formatted results. All systems represent a secure investment that can easily be extended to the scale of your measurement requirements.



“Simcenter Testlab software and Simcenter SCADAS hardware play an important role in the early design stages to confirm the simulation results, but we also use our testing solution extensively for qualification requirements, like the IEC 61400.”

Jari Toikkanen
Head of R&D and Manager of Conceptual Design and Analysis
Moventas

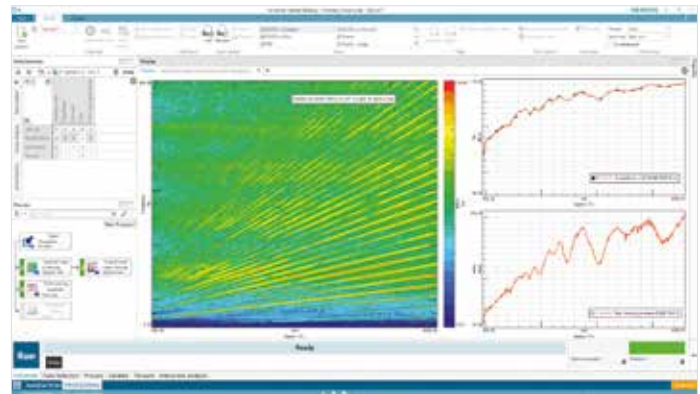



Simcenter Sound Camera

Simcenter helps engineers effectively localize and quantify sound sources for a wide variety of applications over a large frequency range in the far and the near acoustic field. Using the Simcenter SSL hardware and software combination, the engineers can directly visualize sound at the source.

This solution uses Simcenter Sound Camera™ hardware, a modular, high-quality digital microphone array that offers an instant overview of sound sources on any noise-generating object. Its complementary, dedicated software instantly delivers clear, graphical results that are easy to interpret and share. Simcenter Sound Camera accelerates acoustic troubleshooting, and can be combined with Simcenter Testlab for increased engineering insight.

Simcenter Soundbrush

Simcenter can help engineers visualize exactly what they hear and provide detailed, immediate results for easy identification of noise sources, including sound intensity values, sound propagation directions and sound power values. Simcenter Soundbrush combines 3D sound intensity with SSL for 3D real-time acoustic troubleshooting.



STRUT INFLATION PRESSURE
(See extended) P.S.I.
TO CHECK VALVE CHARGING
(FELING AND INFLATION)
REFER TO MAINTENANCE MANUAL

STRUT

Dedicated testing technologies



Simcenter T3STER

Simcenter can help manufacturers in the semiconductor, consumer electronics, transportation and light-emitting diode (LED) industries conduct fast and accurate transient thermal tests, as well as measurements and characterizations of integrated circuit (IC) packages, LEDs, LED arrays and systems.

Simcenter T3STER solutions fully support the transient dual interface method according to the JEDEC Solid State Technology Association standard JESD51-14, and the latest LED thermal testing standards JEDEC JESD51-51 and JEDEC JESD51-52. Additionally, Simcenter T3STER can generate compact thermal models that can help increase simulation accuracy in Simcenter Flotherm.

Finally, engineers can use Simcenter T3STER for post-stress testing in reliability analysis, and do nondestructive failure detection of IC packages and LEDs.

Simcenter Qsources

Simcenter includes a comprehensive suite of advanced vibration testing equipment and acoustic monopole sources for noise and vibration testing. Simcenter Qsources hardware seamlessly integrates with all Simcenter testing software, giving engineers a unique solution combination that exceeds current market standards for productivity, data accuracy and overall customer expectations.

Simcenter Qsources includes vibration testing equipment, developed and manufactured with input from customers and suppliers over the last 40 years. The resulting suite of vibration equipment with real-world application capabilities deliver optimal product functionality, quality and reliability.

“With our new Simcenter testing solution, our job is getting easier. We will have less issues and a smoother process and the data gets into the hands of the analysis team much faster than before. They are reassured that the data is correct and they get it faster – as much as 10 times faster.”

*Carine Pont
Mechanical Test Manager
Airbus Defence and Space*

Empowering multidisciplinary design space exploration

“Pratt & Miller has evaluated multiple design exploration tools, and HEEDS, with its SHERPA algorithm, is the only one that can solve our highly constrained models.”

*Jesper Slattengren
Technical fellow
Pratt & Miller
Engineering*

Manufacturers that want to use simulation as a tool to drive innovation need to combine accurate CAE solutions with an efficient and easy-to-use multidisciplinary exploration framework. It should provide insight into the influence of all parameters at hand, and automate the quest for the best design options, thereby fully involving the available high-performance computing infrastructure.

Simcenter helps companies leverage any existing investment in simulation tools, and use automation and intelligent search to accelerate performance predictions and design modification decisions. In this way, they can discover better designs faster.

HEEDS

HEEDS™ software is a powerful design space exploration solution that accelerates the design engineering process by automating analysis workflows, maximizing utilization of existing investments in computational resources, efficiently exploring solutions and assessing performance to make sure real-world goals can be met.

Most simulation software just allows designers or engineers to predict how a predefined design or small variations around it will perform. But with HEEDS, they can first define a parametric model using any number of internal or commercial simulation tools, and then efficiently search the available design space by evaluating multiple variants to find innovative solutions that meet or exceed performance targets.

By using this design space exploration approach with HEEDS, companies can automatically discover innovative designs in a fraction of time it would take to perform a handful of manual iterations. This powerful software provides great value to organizations interested in identifying the best possible options during all design stages.

In HEEDS, companies can define their design workflows and automatically share data between different CAE tools without the need for custom scripting, saving time and facilitating collaboration between departments. HEEDS leverages existing hardware investments by efficient use of all available resources, including workstations, clusters and cloud computing resources both on-site and off-site.

As opposed to most traditional optimization tools that require highly specialized technical expertise and model simplification, HEEDS users can follow a streamlined process, using their existing models regardless of complexity or concern for the number of parameters or constraints.

Finally, HEEDS helps users visualize performance tradeoffs between competing objectives and constraints with plots, tables, graphs and images. HEEDS provides the ability to easily compare performance over a wide spectrum of designs to find feasible design families that exhibit desirable characteristics and robustness.

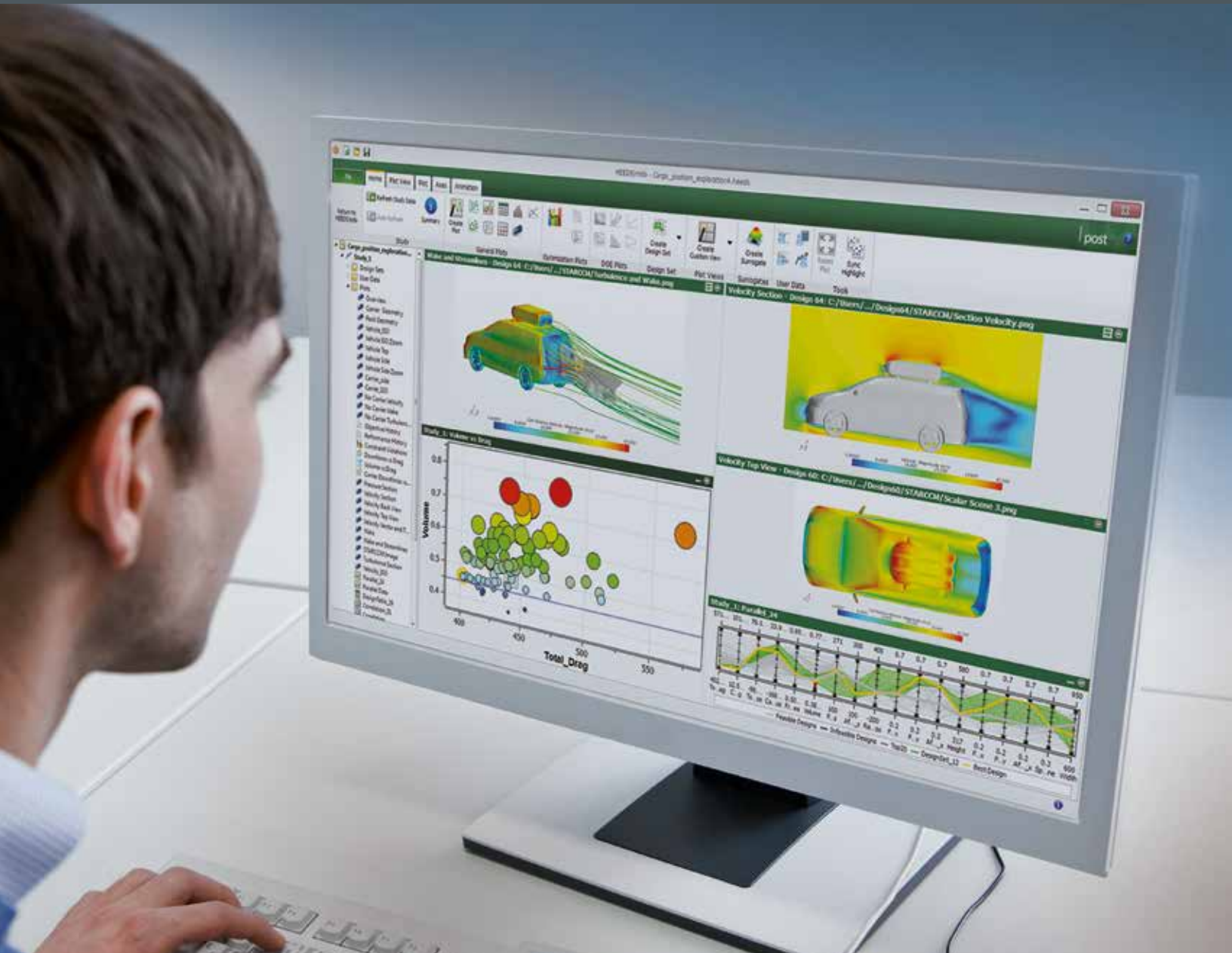

Benefits

- Find multiple innovative solutions
- Standardize design processes based on best practices
- Significantly reduce design time
- Better leverage your software and hardware resource investments
- Gain deeper insights into design behavior

Managing simulation processes, data tools and workflows

“Siemens was a natural choice to be our PDM system vendor. They gave us the benefit we expect from this integrated enterprise solution.”

*Dr. Ulrich Fox
Manager, Mesh Development Group
Ford Motor Company*

Manufacturers that want to deliver smart products that get updates and change when in use, or send use-based feedback to design teams, will need to stay connected over the entire lifecycle. This requires a digital thread that connects the various phases and traceability of requirements, models and data.

Simcenter helps companies get control of simulation data and processes in the context of an overall PLM system.

Simulation process management

By using Simcenter CAE Simulation Management software, powered by Teamcenter, users can efficiently manage and share complex simulations with all decision makers, confirming the product is designed right the first time. Simcenter CAE Simulation Management enables you to avoid common problems, such as analyses performed using obsolete data, poor visibility into results and results arriving too late to drive the design direction.

Simcenter System Simulation Management software, also powered by Teamcenter, is used to manage data from Simcenter Amesim and other system simulation tools, providing a collaborative environment for model-based systems engineering (MBSE) data. Simcenter System Simulation Management is the repository where engineering teams can create an organizational model for system simulation data and facilitate classification, query and retrieval according to relevant engineer schemas.

This solution features version management to enable lifecycle management of data throughout the product development cycle, as well as variant management to deal with multiple representations of system components and subsystems for system model instantiation, depending on the stage of development and the objective of the simulation. Additionally, designated stakeholders can get role-based access control so various collaboration workflows can be implemented.

Simcenter System Simulation Management facilitates knowledge capitalization for a development organization's application of MBSE.



Benefits

- Support the increasing volume and complexity of simulation work by managing data and processes
- Increase confidence in your simulations with complete traceability from requirements through design and validation
- Speed simulation by reducing time to find data and enabling greater re-use of work
- Deliver results faster by standardizing and automating simulation processes
- Minimize implementation costs and risk by leveraging the proven Teamcenter platform as your common infrastructure solution

Combining skills in engineering and consulting services

“The 10-year partnership with Simcenter Engineering significantly strengthened our position with automotive OEMs. We are now recognized as a valuable technology partner and work together on improving fuel consumption while ensuring comfortable driving.”

Hiroki Tsuji
Group Manager
Aisin AW

Simcenter is a product of Siemens' experience, skills and application know-how, which are the ideal ingredients to provide services that help customers optimize complex product design and improve processes.

In Simcenter, companies can engage with a team of technical experts with broad engineering proficiency in helping original equipment manufacturers (OEMs) and suppliers in automotive, aerospace and other manufacturing industries reduce costs and go to market faster by balancing functional performance attributes against key program drivers. By using simulation and testing, Simcenter engineers help achieve complex design goals and deploy innovative engineering processes.

Simcenter Engineering and Consulting

Simcenter Engineering and Consulting services offer a scalable partnering model to support product development from the smallest outsourcing tasks to full program management. At the highest collaboration level, experts help companies refine engineering processes by delivering turnkey systems, software and services.

Simcenter experts help customers achieve excellence in both product design and late-development troubleshooting. The team enables engineers to apply the latest attribute tools and methods as part of their standard process. Customers are personally involved in every step through hands-on collaboration. Many technology transfer programs are part of application-based development projects, providing immediate benefits and corresponding profits from deploying advanced techniques.

The Simcenter team has a culture of open technology sharing, including models, data and milestone reports. Simcenter Engineering and Consulting is an integral part of many engineering departments and development programs. Through on-site projects or customized technology exchanges hosted at in-house facilities, Simcenter Engineering and Consulting services advance corporate engineering knowledge.



Benefits

- Increased product performances thanks to expert help
- Tackling critical product challenges
- Deploying a better process that frontloads design choices
- Reduced time-to-market by up to 30-to-50 percent
- Reduced weight and development cost

Maximizing engineering value with customer support

“The Siemens Digital Industries Software specialists offer us first-class support and training. We’ve had a good relationship with them for many years. They organize learning events, offer us a lot of materials in the local language, and they host public discussion forums where more than a thousand professionals exchange ideas.”

*Liu Erbao
Director, Body NVH
Engineering
Great Wall Motor*

To ensure engineering innovation in a productive manner, companies need to maximize the effective use of high-end software simulation solutions and advanced test systems. Therefore, as product complexity rises, it becomes increasingly important to simultaneously master various engineering and physics disciplines: Domain specialists can no longer work in isolated silos. On the contrary, these engineers need to be surrounded by professionals who have competencies outside their area of expertise. They need ready access to a global community of simulation engineers and the expertise must be delivered as part of individualized customer support.

At Siemens, becoming a Simcenter customer means more than purchasing world-class software; it opens the door to an unrivaled wealth of engineering proficiency. Our technology solutions are backed by a global team of analysis, simulation and test experts who are dedicated to helping our customers’ engineering departments meet the challenges of their industry and exceed the expectations of their market.

We aim to assign all Simcenter customers a dedicated Simcenter customer support engineer, whose mission is to proactively assist them so they can gain maximum value from their investment in our technologies. The Simcenter engineer achieves this by building a relationship with their customers, understanding their technical challenges and business goals, and providing personalized, detailed technical guidance. By maintaining a continual proactive dialogue with our customers, we seek to identify their engineering simulation or test issues before they occur, and to provide immediate resolutions if necessary. Our global team of highly skilled, experienced simulation and test engineers can rapidly provide customers with an appropriate local expert to deliver top-quality engineering analysis on time, every time. Simcenter support engineers help customers solve more than just technical problems; they help them keep their business ahead of the competition.



Benefits

- Prompt and effective telephone-based technical support
- Access to web-based technical support
- Fast solutions to problem reports in point releases
- Latest technologies available in major releases

About Siemens Digital Industries Software

Siemens Digital Industries Software, a business unit of Siemens Digital Industries, is a leading global provider of software solutions to drive the digital transformation of industry, creating new opportunities for manufacturers to realize innovation. With headquarters in Plano, Texas, and over 140,000 customers worldwide, we work with companies of all sizes to transform the way ideas come to life, the way products are realized, and the way products and assets in operation are used and understood. For more information on our products and services, visit [siemens.com/plm](https://www.siemens.com/plm).

Headquarters: +1 972 987 3000
Americas: +1 314 264 8499
Europe: +44 (0) 1276 413200
Asia-Pacific: +852 2230 3333

Restricted © Siemens 2019. Siemens and the Siemens logo are registered trademarks of Siemens AG. Femap, HEEDS, Simcenter, Simcenter 3D, Simcenter Amesim, Simcenter FLOEFD, Simcenter Flomaster, Simcenter Flotherm, Simcenter MAGNET, Simcenter Motorsolve, Simcenter Samcef, Simcenter SCADAS, Simcenter STAR-CCM+, Simcenter Soundbrush, Simcenter Sound Camera, Simcenter Testlab, Simcenter Testxpress and STAR-CD are trademarks or registered trademarks of Siemens Product Lifecycle Management Software Inc. or its subsidiaries or affiliates in the United States and in other countries. All other trademarks, registered trademarks or service marks belong to their respective holders.
56121-C44 6/19 Y