

Engineer

INNOVATION

Issue 2

In this issue

Corrdesa:
The cost of corrosion
Page 8

OPEL Automotive:
Thermal management of
automotive headlights
Page 12

Airbus Helicopters:
Saving time and cost
for airworthiness
certification
Page 42

SIEMENS

Ingenuity for life

siemens.com/simcenter



The digital perspective



Siemens PLM Software

Jan Leuridan
Senior Vice President
Simulation and Test Solutions

Reading the customer success stories shared in this edition of Engineer Innovation I am reminded that we live in an increasingly digital world. But with increasing digitalization comes unprecedented levels of data. Ensuring this data is accessible, traceable and enabling maximal insights underpins Siemens' digital twin technology so I am reassured to read how our customers are exploiting Simcenter™ software's connectivity with other tools such as NX™ software, Teamcenter® portfolio and MindSphere® the cloud-based, open IoT operating system from Siemens to optimize and mine the available data, improving accuracy and bringing products to market faster.

Our vision for the digital twin is on page 4, here we articulate how we can deliver insight that increases confidence and ultimately drives greater engineering efficiency. That efficiency is evident in the customer success throughout this issue, where you the customer lead industry to Engineer Innovation.

The automotive industry has long led the charge into increased digitalization and in this issue we share the success of Opel, Hyundai and Volvo trucks who benefit from Simcenter simulation and test solutions to build various parts of the digital twin. Joe Barkai, Chairman SAE Connected cars and our colleague Jan van Den Oetelaar give us a Reality Check on Autonomous Driving: how far we have come, also how far we have to go.

The results achieved by our customers are impressive. Hyundai have been able

to reduce vehicle tests by 40 percent, Electra Mecannica moved from concept and digitalization to road-ready in just 18 months, and Volvo Trucks are able to perform acoustic testing concurrently with other tests to save valuable time without compromising results.

It isn't only the automotive industry that is benefiting from Simcenter solutions, Trek is one of the worlds' largest cycle manufacturers, building over 1.5 million bikes each year. They have reduced the runtime on simulation models from six hours to just 22 minutes. Airbus helicopters demonstrate how they have reduced their testing commitment thanks to improved model accuracy from simulation and the US Military are reducing costly corrosion issues with the digital twin.

No Engineer Innovation issue would now be complete without our Geek Hub, where our engineers push some of the boundaries of our solutions. Read on to find out if they managed to fry an egg on a CPU.

If you enjoy reading and sharing customer success then consider presenting at or attending the Simcenter Conference later this year. The event takes place in Amsterdam, 2nd – 4th December and will include 100+ customer presentations, industry insight and product training alongside our exhibition of all things Simcenter. More information: www.siemens.com/plm/simcenterconference ■

Contents



24



28



12



42

Engineer Innovation

- 4 The digital twin
- 8 Corredsa: The cost of corrosion
- 12 Opel: Frontloading CFD: Thermal management of automotive headlight
- 18 ZF Wind Power: Harnessing the power of the wind
- 24 Electra Meccanica: Electric Automotive manufacturer uses Simcenter and NX
- 28 Trek Bicycle: Design space exploration
- 34 3D Analysis of induction melting furnaces with cold crucible
- 38 Hydro-Québec: Canadian energy provider uses Simcenter testing solutions to optimize power output
- 42 Airbus: Helicopter manufacturer uses Simcenter Amesim to minimize time and costs for certifying airworthiness
- 50 Hyundai Motor Company: Global auto manufacturer uses Simcenter to optimize hybrid vehicle performance
- 54 Home appliances: From noise troubleshooting to noise reduction strategies
- 58 Volvo Trucks: Truck manufacturer uses Simcenter Testlab and Simcenter SCADAS to improve cabin sound quality

Regular Features

- 20 Interview: Reality Check: Autonomous driving - "It's much easier to create a revolution than to maintain it."
- 46 How To Guide: How to assess the aircraft cabin cooling sizing with Simcenter Amesim
- 62 Geek Hub: The complexities of frying an egg on a CPU
- 66 Brownian Motion

The digital twin

By Ravi Shankar, Marketing director, Simulation & Test Solutions, Siemens PLM



Within the last few years, a convergence of various technologies is transforming engineered products in many different industries. What are these trends? You will know them well if you are involved in any capacity with bringing new products to market that require significant engineering development – cars, planes, machinery and medical devices to name just a few. Consider the potential of new materials to transform the relationships between form and function, new manufacturing processes that make it possible to produce shapes that were never before possible, the integration of software and electronics to improve performance, and the opportunities that Internet of Things (IoT) data can afford to satisfy customer needs in new ways. Apart from these, there are the trends for mass personalization, greater demand for fuel efficiency, and more regulations including the mandate to reduce emissions.

The net result of all these is an increase in complexity of both products and the processes that are used to engineer them. The challenges resulting from this increased complexity are significant. Long-standing companies with rich histories of innovation in one area may struggle to leverage their experience in emerging fields. Will a company that knows how to build mechanical locks lead the way to internet-connected devices that can be locked and unlocked from a smartphone? Or will they watch helplessly as new companies take away market share? How will they integrate their experience on the mechanical side with newly acquired knowledge on sensors, electrical actuators and internet connectivity to bring new products to market faster than start-ups? If a company is not thinking of these types of questions, it will surely be left behind in just a few short years.

There is a way forward, it requires a mind-set to embrace the concept of digital twins.

Challenging the way engineering is done

These trends mean there are far more unknowns in the engineering process that manufacturers must face. This leads to longer lead times and greater risks that they will not achieve the product and business objectives. Companies that fail to recognize and react to these changes risk losing business and market share. So, how can companies respond to these new challenges?

What if a company could adopt new practices and tools to give it a competitive edge? Today engineering data and models are scattered in different silos. While most companies have activities and groups that are performing tests, generating benchmark data, running 1D simulations, and performing computer-aided engineering (CAE) work, there is no ability to easily draw conclusions across the silos. The test engineers may not even be aware that a 1D simulation has been performed. The CAE department may not have access to the latest benchmark data. What if they can use all the data across multiple engineering activities and convert this into meaningful insights that can drive product decisions faster than the competition?

When all these different silos of models and data are linked together, there is the possibility of more realistic models that can be used to predict behavior. Data from one model may be used as input to a different model that is built later in the process. The models themselves can mature over time; they can even be kept up-to-date with actual usage data obtained through IoT-enabled products. In addition, a layer for analytics that leverages data from a variety of sources can help uncover trends and insights earlier.



The digital twin concept

An important way to address challenges of complex system development is by building a set of highly accurate models that help predict product behavior during all lifecycle phases. These models, which are called “Digital Twins,” come in multiple scales and instances for various applications, integrate multiple physical aspects, contain the best available physical descriptions and mirror the life of the real product and its production process.

The concept of a digital twin is applicable across various lifecycle stages of a product or system:

- From the ideation phase, with a digital twin of the product that helps define/improve designs and analyze performance;
- To the realization phase, with a digital twin of the manufacturing process, and finally; and
- To the utilization phase, with a digital twin of the product in service and through retirement.

When companies integrate the entire digital twin together, they have access to a holistic digital twin which becomes the backbone of their product development – capable of delivering greater insight, reducing development cycle time, improving efficiency and increasing market agility.

More than just a simulation model

The engineering performance digital twin is more than a simulation model. Instead it is a living entity that is extended, completed and updated throughout the asset’s lifecycle, further enriched with data obtained during the physical asset’s operation.

The concept of using physical models that mimic behavior of actual products is not new. NASA’s Apollo program used identical space vehicles so that one of the vehicles could be used to test out procedures on earth while the other was in space. The concept of a “mirrored spaces model” was introduced in executive courses on product lifecycle management at the University of Michigan in 2002. Perhaps the first use of the phrase “digital twin” is seen in 2011/2012 in reports by NASA and the U.S. Air Force Research Laboratory (AFRL).[1]

In the NASA report, the term was defined as follows: “A digital twin is an integrated multi-physics, multiscale simulation of a vehicle or system that uses the best available physical models, sensor updates, fleet history, etc., to mirror the life of its corresponding flying twin.”

Additionally, three things are needed for the digital twin to be realized as described by the NASA report:

- A realistic simulation model (the digital twin) that can predict performance;
- A specific physical asset or family of assets which is the real equivalent to the digital twin; and
- Information flow between the physical asset and the digital twin so that the latter is dynamic and evolves over the life of the asset.

The availability of digital twins can help predict performance of complex products and systems throughout the product’s lifecycle. Consider an industrial product being used in Finland. A simulation model by itself would assume nominal behavior and nominal loads and therefore would not be able to accurately predict performance for the specific asset in question. With a digital twin approach, the situation is different. Sensors on the product may provide noise signatures. This data in conjunction with a digital twin that incorporates knowledge of the as-used (versus as-designed or even as-built) condition of the product, other sensors that provide current and historical loads, temperature fluctuations, etc. can then be used to anticipate and predict a vibration problem within the next 10,000 duty cycles.

So, while the simulation model is essential to the creation of a digital twin, it is not sufficient to have only a static simulation model. It must evolve over time and the evolution must be captured at all stages.

As such the digital twin begins its existence even before its physical counterpart exists and continues to evolve and support the next generation of the physical asset long after the current generation ceases to exist.

The digital thread

The concept of the digital thread is related to the concept of the digital twin. The digital thread captures information on all the data, models, processes and resources from requirements to design and engineering to usage for the digital twin. And it does this across all the functional areas and for all stakeholders. Thus where the digital twin can be considered as the virtual entity that can predict

REALISM
Increasing confidence

CONTINUITY
Enabling collaboration

EXPLORATION
Delivering insight

PRODUCTIVITY
Driving engineering efficiency

ENGINEER INNOVATION

performance, the digital thread tracks the evolution of the digital twin and helps to keep it relevant and current.

To help companies with a measured approach to the adoption of digital twins in product development, this simple model with three axes representing different focus areas to improve core capabilities related to digital twin adoption – realism, continuity, and exploration.

Realism

To address increasingly complex systems and technologies, it is critical that companies have a realistic representation of their product to give confidence in their designs and ensure that design decisions are correct. Improved confidence in both simulation and test data can reduce the need for over-design, reduce end-of-cycle physical testing and reduce the number of field failures. All this leads to faster time to market and significant cost savings. In addition to that, having confidence and trust in simulation and test processes is also critical to make real-time decisions based on feedback from the digital twin.

Continuity

To support the digital twin, it is critical that performance engineering processes are not isolated and disconnected from the rest of the organization or the PLM process. Companies need a digital thread that connects people, projects, models and data to efficiently tackle the innovation of these very complex problems. If companies are able to reduce barriers and enable enterprise collaboration, they not only increase their process efficiency, but also get a more holistic view to make the right decisions with all stakeholders across the organization and are able to close the loop between requirements, design and verification over the complete engineering cycle.

Exploration

Having realistic and integrated processes and models today is not enough. Companies must be able to deploy them so that they bring the necessary insight to make design decisions and do it quickly. A key value of digital performance analysis is that it allows for quick and cost-effective evaluations of

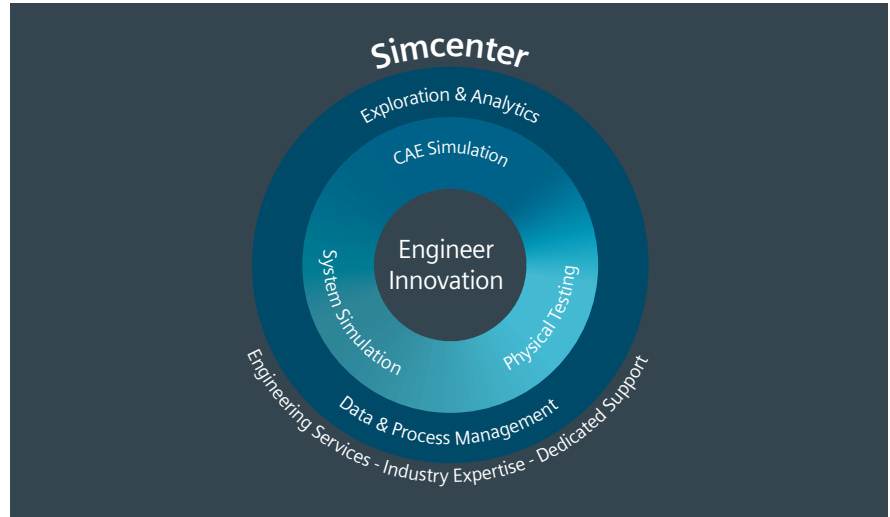

design changes. To get the most benefit from simulation tools, companies must intelligently explore the design space to quickly understand design drivers and trade-offs, and discover better designs. This of course also requires the ability to interrogate the information from these hundreds of designs to make decisions. High-quality analytics as well as visualization are also critical to make simulation useable and accessible.

Productivity

The backbone for all of this needs to be a set of streamlined and automated workflows, consistent interfaces and efficient processes that reduce engineering time and allow engineers to spend their time where it matters: innovating.

A digital twin must deliver insights in time to influence decisions – decisions about service or predictive maintenance, timing of upgrades to improve performance, or decisions taken during development phases. The organization has a number of things to consider here: how to push the use of system models early so that the right architectures are selected; ensures a consistent user experience across domains and enable models and data to be re-used; streamline data flows between applications; automate workflows to achieve speed as well as standardization; ensure efficiency in testing and augment test data with simulation data to enable faster and deeper insights; invest in the right computing resources to enable rapid evaluations of hundreds of design variants; and enable large, complex

models to be manipulated quickly and visualized easily.

The Solution

Siemens recognized the product complexity trends more than a decade ago and embarked on a journey to build the strongest portfolio in the industry in support of building digital twins. Our belief for the need to adopt this new approach for performance engineering in support of the holistic digital twin has led us to the creation of the Simcenter™ portfolio. Simcenter delivers best-in-class CAE simulation, system simulation and testing solutions, as well as solutions for design exploration and data management. The portfolio consists of longstanding solutions and brands from various legacy companies including UGS, SDRC, LMS, CD-adapco, Mentor Graphics and others. The portfolio continues to evolve and grow through internal R&D, acquisitions and solution integration. Our intent is nothing less than delivering to our customers the capabilities and support needed to build the most robust and accurate digital twins to engineer innovation.

References

[1] E.H. Glaessgen, D.S. Stargel, "The Digital Twin Paradigm for Future NASA and U.S. Air Force Vehicles," Proc. 53rd Structures, Structural Dynamics and Materials Conference – Special Session on the Digital Twin, AIAA, Honolulu, Hawaii, USA 2012. Also available here: <https://ntrs.nasa.gov/archive/nasa/casi.ntrs.nasa.gov/20120008178.pdf> ■

The Cost of Corrosion

Fighting the U.S. Military's billion-dollar corrosion problem with Siemens PLM software



The U.S. Military has a problem.

A problem that is eating away its assets, equipment and budget annually - corrosion.

Costing a cool US\$25 billion per year, 4 percent of the U.S. Department of Defense (DoD) budget, corrosion is more than just an eyesore for the military. The staggering economic impact aside, corrosion from environmental interaction puts military equipment, mission readiness and lives at risk. The cost of corrosion is analyzed annually by a DoD Corrosion Office. A Corrosion Prevention Advisory Board exists for all new military systems. In the U.S. Navy and Marine Corps, surprisingly the world's second largest air force, corrosion costs US\$3.6 billion annually and accounts for roughly 30 percent of maintenance costs.

Truth is corrosion cannot be prevented, especially not in the harsh naval environments. NACE International, the global corrosion authority, puts the annual cost of corrosion at US\$2.5 trillion worldwide and US\$250 billion in the U.S. But the cadmium and chromates that provide corrosion protection are being phased out due to environmental concerns. The use of dissimilar materials such as carbon fiber composites and aluminum in the presence of electrolytes creates galvanic corrosion, a problem that causes around 80 percent of structural failure in military aviation, and putting aircraft out of service for 25-30 days annually.

But 25-30 percent of these corrosion issues could be avoided with better corrosion management practices and material selection. In monetary terms, that's a whole lot of dollars. Promising? Yes. But the current design guidelines and military standards are based on outdated science and data that are inadequate for addressing modern materials and their corrosive behavior.

The U.S. Military clearly has a problem – tackling the colossal cost of corrosion. The solution? An unlikely ally in Corredesa, a small, 8-person company

out of Georgia, U.S.A. bringing years of corrosion and Computer Aided Engineering (CAE) expertise. Corredesa is helping the U.S. Navy implement a corrosion-resistant design approach using Simcenter STAR-CCM+™ and Teamcenter® from Siemens PLM Software. Corredesa's corrosion analysis workflow provides quick material selection to resist galvanic corrosion, saving thousands of testing hours and millions of dollars for the U.S. Navy.

An outdated method and a US\$228 million repair bill

Corrosion is electrochemistry gone rogue, degrading materials through reaction with their environment – air, water, an electrolyte like salt water, or other materials. U.S. Military assets operate in the harshest environments – freshwater, salt water and oceanic moisture. In the presence of these liquid electrolytes, dissimilar materials with differing electric potentials in contact (either directly or indirectly) are prone to galvanic corrosion. In simple terms, galvanic corrosion is electric corrosion. One metal acts as an anode corroding quickly while the other acts as a cathode with slower corrosion.

Today, most corrosion resistant design is done using the galvanic series – tables and charts ranking materials by their electric potential based on half-century old materials and data. The galvanic potential difference between the materials causes one to act as an anode accelerating corrosion. Designers use the tables to choose materials and coatings based on their potential to corrode.

But the data from these tables is less of a science and more of a suggestion. Why? The potential is measured only for individual metals, not accounting for other metals in proximity. The electrochemical kinetics, electrolyte composition and temperature are not considered. Meanwhile, aerospace materials and coatings are constantly evolving to meet performance and environmental requirements.



Figure 1: F-18 wing and airframe corrosion

The galvanic series was adopted as U.S. Military Standard (MIL-STD) and Detail (MIL-DTL) – documents standardizing design specifications and requirements. One such standard, MIL-STD-889, for galvanic compatibility assessment is required of all military aircraft programs. But the outdated standards, even when applied correctly, can still result in poor material choice and oversight.

Case in point: the US\$228 million bill for repairs and retrofits related to corrosion on the F-22 fighter jet. “The root cause of this problem lay within the galvanic couple between the conductive gap filler and aluminum skin panels”, says Daniel Dunmire, Director of the DoD Corrosion Policy and Oversight Office.

To its credit, the DoD has updated MIL-STD889C to propose an approach using galvanic current instead of potential. The Office of Naval Research has initiated a Sea-Based-Aviation (SBA) program, involving Corrdesa, to develop computational methods for corrosion analysis and prediction.

Corrdesa’s science-based corrosion analysis with simulation

“I’ve been kicked out of meetings in the past for saying you can simulate electroplating and corrosion” - Alan Rose, chief executive officer (CEO) of Corrdesa, makes no bones about the popular perception of corrosion simulation. “But acceptance is growing. Today, electroplating simulation is a requirement in many OEMs. With the right verification, validation and accreditation, it is common sense to use simulation tools for corrosion prediction”. Alan’s 25 years of CAE experience shines through when he talks about corrosion simulation. Meanwhile, Keith Legg, CTO, is a world-renowned expert on corrosion and coatings. It doesn’t come as a surprise that Corrdesa is leading the way in marrying corrosion and CAE.

Corrdesa’s corrosion analysis method is a three-step process:

- An internationally recognized electrochemical database;
- 1D Corrosion Djinn tool to analyze 80-90 percent corrosion threats from

- simple geometries; and
- 3D CAE with Simcenter STAR-CCM+ for complex components and high-risk areas.

As part of the SBA program, Corrdesa worked with the U.S. Navy to create a standardized electrochemical database. The new database in Corrosion Djinn comes with data for modern alloys, coatings and surface treatments, and it is constantly updated with polarization curves, showing current density and electrode potential for new materials and coatings. With the updated data, the Djinn tool calculates galvanic current and corrosion rate between dissimilar materials, coatings and treatments for simple geometries. For complex geometries, computational fluid dynamics (CFD) simulations with Simcenter STAR-CCM+ predict the changes in corrosion rate that come with variations in film thickness, to show where corrosion will occur and how bad it will be. The CAE approach takes hours to days per interface to offer prediction and fixes for high-risk areas of complex products.

“Rather than our customers wasting thousands of hours testing materials and trying coatings, they can just characterize them in one day in the lab. Combine that with science-based corrosion modeling and you can quickly assess different materials and choose the best one”, notes Alan. “Testing materials to make them corrode takes time. With CFD, it’s non-destructive and you can virtually test again and again”.



Figure 2: The problematic F-22 Raptor jet with a US\$228 million corrosion repair tag

Is the simulation science solid?

Simulation needs proof. In a strict military design environment, the need for verification and validation is even greater. The updated military standards and Corrdesa’s involvement in the SBA program have opened the door for greater acceptance of corrosion simulation. To add to this, Corrdesa’s design method was validated against many existing cases.

When compared against test data from accelerated tests for NAVAIR galvanic coupons, the 1D method gave acceptable predictions for bulk electrolyte conditions. The 3D CAE approach, accounting for film thickness and fluid film, improved prediction for thin electrolyte films. Both quantitatively and qualitatively, good predictions were achieved with different test chamber results to validate the approach.

But would it work in a real-life scenario? On many of the Navy’s F-18 aircraft, fastener holes corrode heavily. Repair involves inserting a stainless steel bushing or replacing a smaller bushing with a larger one. Galvanic tables point to 15-5 PH/Bare Al coupled fasteners as the answer. However, corrosion analysis by Simcenter STAR-CCM+ and Djinn tells a different story. Simulation shows that not only is Ti6Al4V/anodized Al a better combination, but that the best solution is to modify the bushing to reduce oxidation.

Recently, a French electrical connector manufacturer couldn’t meet the contact resistance requirements while using a new material (a zinc nickel combination). To meet the requirements,

manufacturers were using polytetrafluoroethylene-filled electroless nickel (EN-PTFE) on aluminum because it met the requirements for conductivity. But corrosion analysis and US Navy testing showed EN-PTFE connectors corroding cadmium from mated connectors, and accelerating galvanic corrosion of aluminum electrical boxes.

A perfect fit for Siemens PLM software

“I picked Simcenter STAR-CCM+ because of the multiphysics capabilities to model corrosion, fluid film, thin film, condensation, etc. I can quickly and accurately calculate electrolyte thickness, choose the correct polarization, material data and calculate corrosion rate distribution”, says Alan. “By hooking into a well-respected, verified and validated code like Simcenter STAR-CCM+ which our customers already use and have paid for, I can quickly assess the materials, choose the best option and minimize testing. Everyone wins”.

On average, there are thousands of bushings and fasteners just in the

airframe. In other aircraft systems? Thousands more. Finding problematic interfaces, bushings and fasteners among these is a nightmare. Needle, meet haystack.

The answer, according to Alan, is another Siemens PLM software already being widely adopted by Navy and Air Force organizations – Teamcenter. Teamcenter is end-to-end Product Lifecycle Management (PLM) software, integrating information, data, processes and people throughout a product’s life. Teamcenter can identify and document thousands of interfaces and materials. Designers and maintainers can also access all the electrochemical data, Djinn and Simcenter STAR-CCM+ within Teamcenter. For Alan, corrosion and Siemens PLM software are a perfect fit.

Corrdesa’s corrosion resistant design philosophy and Siemens PLM Software have offered a blueprint to tackle the enormous problem of corrosion. ■



Figure 3: Corrdesa corrosion analysis engineering workflow

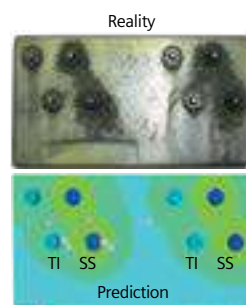

Figure 4: Test vs. Simcenter STAR-CCM+ prediction for NAVAIR Galvanic coupons



Figure 5: Corrosion rate on uncoated lug/bushing in an F-18 aircraft

Frontloading CFD: Thermal Management of Automotive Headlight

By Arthur Jordan, Lighting system engineer - Thermal management and simulation, OPEL Automobile GmbH / Group PSA



In the development of modern automotive headlights a variety of factors and challenges must be considered. One of which is thermal management. Reliable and predictable total thermal management can be achieved with modern simulation tools.

This article is based on project examples from OPEL vehicles, demonstrating an insight into the CFD simulation and validation process with laboratory results. The objective of this work is to integrate different analysis topics in the development process, with a view of achieving an efficient simulation time to evaluate various concepts with significant results.

In today's headlamp development, the link between innovative lighting functions and aesthetics plays a key role. New technologies, such as Intellilux LED® Matrix light, must be integrated with the given design and the available installation space. In addition to optical light design, thermal management is also an integral part of the early concept phase.

The evaluation of these numerous subject areas (Figure 1) within the development process, for each lighting concept (Figure 2), must be done in a short time. The fixed requirement within the lighting system is the design and optical performance. After this evaluation, thermal management should ensure that this is possible without restrictions of installation space and additional cost.

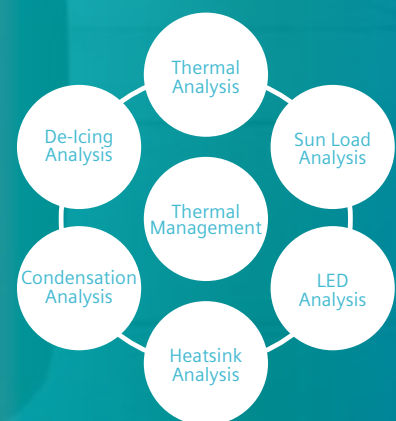

Figure 1: Simulation topics



Figure 2: Concept car OPEL Monza

During the integration of a thermal simulation process, within the development time, there are some requirements to the simulation. Robust and flexible meshing and solving as well as the definition of the physical properties and their dependencies is of essential importance. Furthermore, all relevant topics should be covered with one tool, in our approach with Simcenter™ FLOEFD™ software.

Digital Mock-Ups

The core objective of the development process (Figure 3) in the near future will be the necessity to dispense with physical mock-ups (PMU) and to use pure digital mock-ups (DMU), which describe and reproduce the physical properties and behavior in the real environment. To ensure a robust simulation model, these must be verified and validated. So that additional special effects from real vehicle tests can be mapped and solution-oriented remedial action can be taken.

When generating an efficient simulation model, all components must be defined in advance with regard to their accuracy and influence. It is advantageous not to describe or model

irrelevant attributes in detail as these increase computing time and complexity unnecessarily. Heat sources or components that have a high influence factor on the overall system must be sufficiently defined and modeled.

Motivation

The successful integration of thermal management results in many positive aspects, such as cost optimization through accurate material selection, subsystem quality assurance and shorter development time.

Based on robust simulation results, the investigation of different concepts supports the thermal management and enables additional benefits, such as the evaluation of the optimal technology package.

Validation process

For most headlamp systems, either conventional light sources, such as halogen and xenon lamps, or LED modules are used.

Since both have different ways of transporting heat in headlamps, these

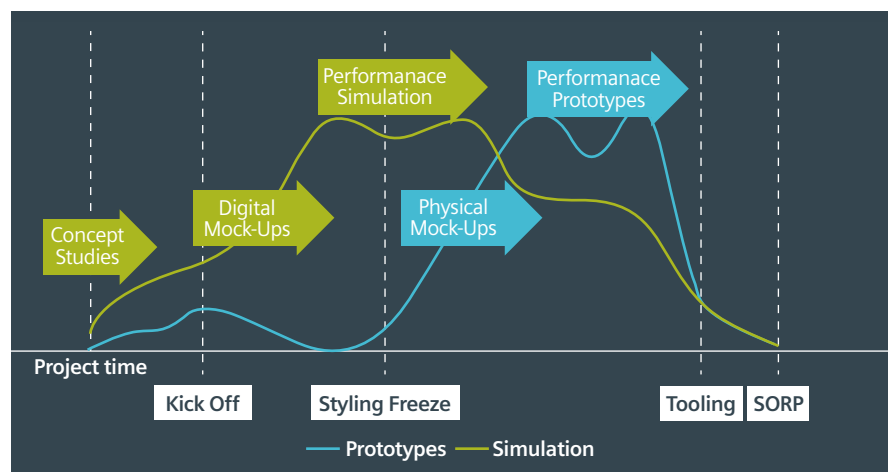

Figure 3: Project time line

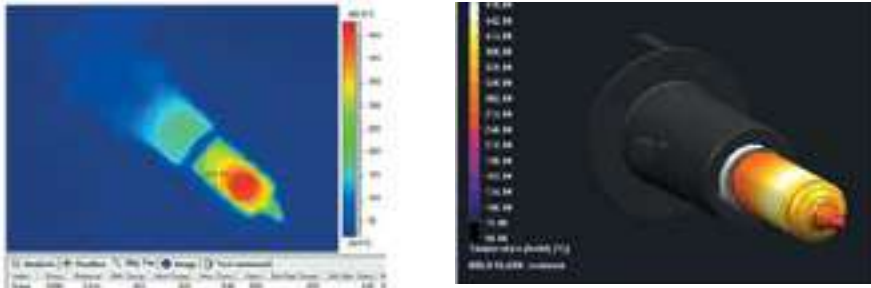

Figure 4: Thermography (left) and simulation (right)

must be described in a physically differentiated way. The validation of conventional light sources is discussed first. Here a detailed CAD representation of the individual components is important. Furthermore, the filling pressure, the noble gas identification and its composition have an influence on the result comparison (Figure 4).

After successful lamp validation, we designed a validation box (Figure 5) in which the cover lens is variable. Depending on the light function, different filter lenses and corresponding light sources can now be mounted. For a meaningful simulation, the temperature-dependent absorption coefficient must be taken into account in the material database.

The rear fog lamp from Opel Adam is shown in Figure 6 as a practical example.

Thermal analysis

Reflector systems or lens modules can be used in the design of front headlamps. Different approaches have to be used for the thermal design. In reflector systems, the resulting convective heat flow is defined decisively as the influencing variable. Based on this, a focal point analyses must be carried out for lens modules that are caused by solar radiation. If, in addition, LED technology (Figure 8) is implemented for the lighting functions, the focus is, among other things, on the heatsink design.

Sun-load analysis

The influence of sun rays on the headlamp system, which result in focusing (Figure 9) of the rays by lens modules or reflectors, poses an additional challenge to the design and material selection of the surrounding components. When defining the angle ranges, the sun's height and azimuth

angle must be specified. Additional effects from the environment, such as the albedo effect, must also be taken into account. With this effect, the sun intensity on the observed object is increased locally by additional reflections from the environment.

Further consideration must be given to transport and parking situations. Depending on the inclination of the road, higher or lower sun elevations must also be considered. Figure 10 shows the focal points in relation to the solar elevation (y-axis) and solar azimuth (x-axis). The yellow fields show a temperature above the vicat temperature, where a material adjustment must be made. With the red fields the temperature is far above the material resistance. Here, the component should be removed from focusing or the surface should be additionally vaporized with aluminum particles.

Heatsink analysis with Design of Experiments (DoE)

In the area of heatsink design there are the following main objectives. To use the smallest possible heatsink mass and at the same time not to exceed the junction temperature of the LED or keep it as low as possible. As the LED temperature increases, the optical performance decreases and the service life is greatly impaired.

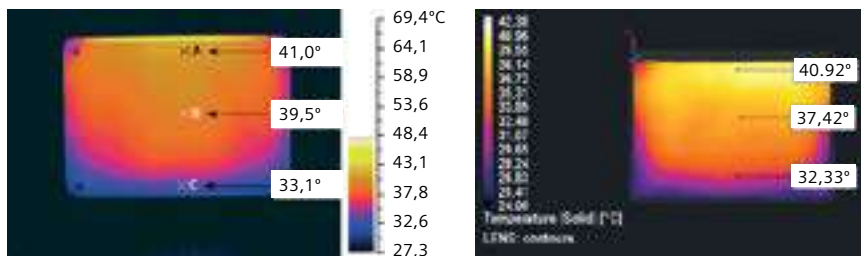

Figure 5: Thermography (left), Simulation (center), and overall model (right)



Figure 6: Rear fog lamp OPEL Adam

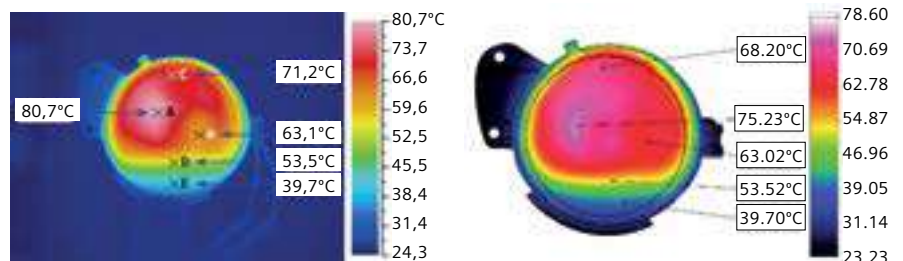

Figure 7: Thermography (left) and simulation (right)



Figure 8: OPEL Insignia headlight models - Matrix LED (top) and halogen version (bottom)

First, the optical pre-dimensioning as well as the determination of the possible installation space takes place. With the help of the DoE method, setting and target variables can now be defined (Figure 11). In this example, a reference heatsink is used as a basis and determined and optimized using the DoE method. The reference heatsink has a mass of 115g with an LED junction temperature of 133°C.

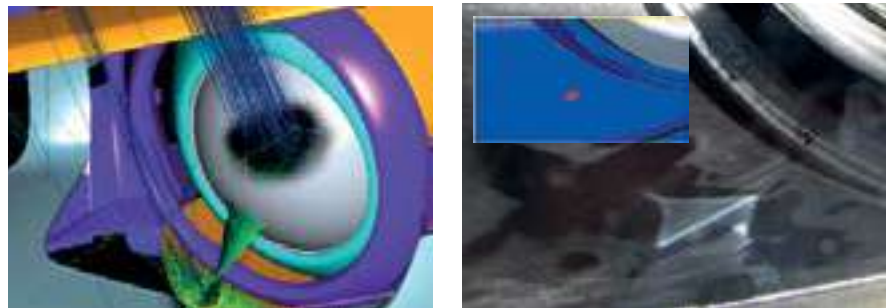

Figure 9: Visualization of the focal point (simulation)

The results are shown in Figure 12. On the basis of this overview, the model with the lowest mass and simultaneously low LED junction temperature is now considered for the further development phase.

Condensation analysis

The topic of condensate in headlamp systems is highly complex because many factors have an influence on the condensate behavior. However, after the concept phase (Figure 13), it is essential to set up an initial preliminary simulation and evaluate the results. In general, moisture is transported into

the system by the ambient air. It should therefore be noted that optimum conditions exist during production and transport (Figure 14).

Now the question arises; which control variables are available to manage the condensate behavior?

Since headlamps require pressure compensation, conventional vents are used - these are positioned at colder points of the headlamp housing so that an advantageous air exchange can occur. Another variant is the membrane solution, which primarily allows an

exchange from the inside to the outside. Here, the coefficients of gas permeability and diffusion must be clearly defined for the membrane model in the simulation. It is also possible to apply an anti-condensation varnish to the inside of the outer lens. The sorption properties must be defined here. Based on these two possibilities, there should be sufficient air circulation within the headlamp system. These can be implemented by various design measures of the individual components. Figure 15 compares a real vehicle condensation test in a climatic chamber with a transient simulation. This test describes

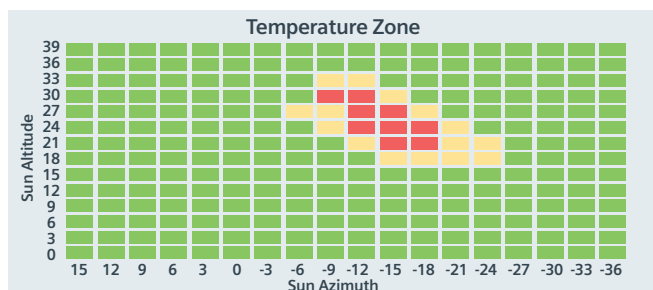

Figure 10: Focal points in relation to sun position

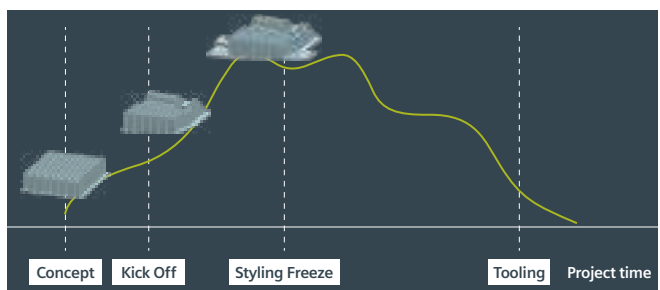

Figure 11 Development process of heatsink

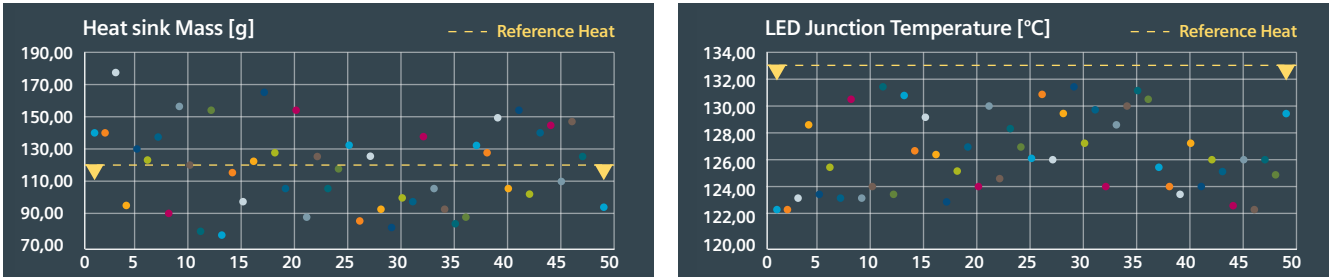

Figure 12: Result of the experiments

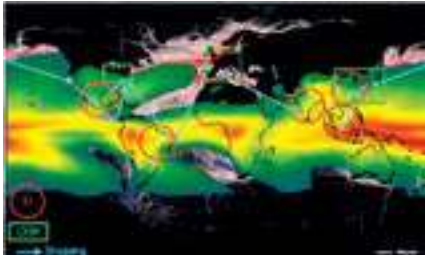

Figure 14: Geographical representation of humidity and OEM and Tier 1 locations

the degradation phase of the existing condensate.

Conclusion

By using Simcenter FLOEFD with an included optimization tool, robust and efficient digital mock-ups can be created. These have made it possible to clearly analyze and evaluate a multitude of concept variants, with regard to the different load requirements and the use of technology. Based on this, DMUs can currently also be used to assess new geographical environments and incorporate them into the conceptual design.

Another objective in this context is to combine design, lighting performance and quality and to ultimately integrate them into ever smaller installation spaces. ■



Figure 13: OPEL Crossland X

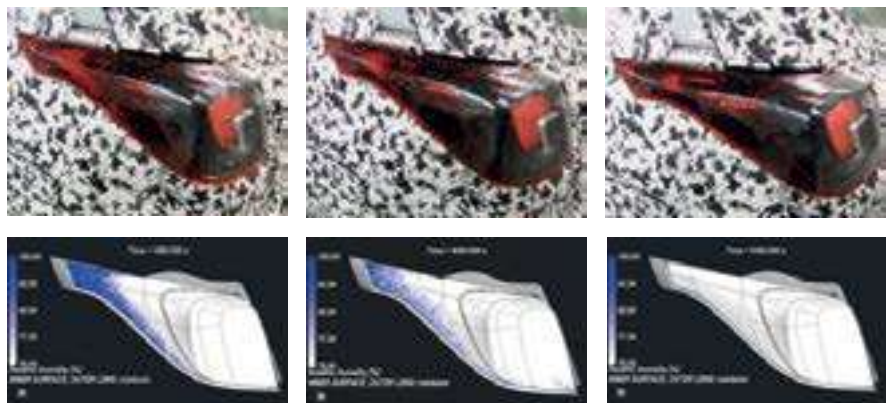

Figure 15: Comparison of Results - Real Test (top) and Simulation (bottom)

“The versatility and the scope of definition in each application are very impressive. This allows us to combine different disciplines in the field of thermal management and consider them holistically.”

Arthur Jordan,
OPEL Automobile GmbH / Group PSA

Harnessing the Power of the Wind

By Jo Loenders, Product Management Engineer, ZF Wind Power



Figure 1. Example wind turbine gear box

Harnessing the power of the wind is nothing new for humankind. The development of the sail for ships allowed for travel and exploration around the globe. There is also the classic image of a windmill, whether it be the large Post Mill style found across Europe or the multi-bladed wind pumps found across the Great Plains of the United States. These allowed humans to settle into different areas by using the energy of the wind and transforming it into useful work, such as pumping water or milling grains. While these technologies can still be used today, it is no longer the translation of wind energy into mechanical energy that is at the forefront of design but the translation in electrical energy.

In fact, wind power is growing worldwide becoming one of the largest

sources of renewable energy. To continue to meet this growing need, large numbers of wind turbines are being constructed both on land and at sea. As a business unit of ZF Friedrichshafen, ZF Wind Power is a leader in the design, manufacture, supply, and servicing of wind turbine gearboxes. Since ZF Wind Power first entered the wind turbine market in 1979, its manufacturing plants have shipped more than 65,000 gearboxes powering more than 120,000 megawatt of installed wind capacity around the globe.

These gearboxes are a critical part of the turbine as they translate relatively slow moving rotation from the large blades to a much higher rotational speed needed for the onboard electrical generator. These systems

consist out of multi stage planetary and helical gear sets. A challenge faced in their design is that as the gearbox operates there is a large amount of heat produced both at the bearings and at the gear mesh contacts. If this heat generation is not balanced with proper cooling and lubrication, the excess heat will cause issues such as overheating of the surface resulting in failure mode scuffing. This will ultimately cause the failure of the machine, and a significant financial cost for repair or replacement, as well as the chance for more catastrophic damage in extreme cases.

This is why during the design of the gearboxes, much engineering time is spent ensuring these systems have the appropriate flow rates and pressures. Originally this process took place using Microsoft Excel to calculate the expected flow rates based on the pressure drop of the individual parts of the gearbox flow paths. However this was a very complex and time consuming process as the distribution systems for the lubrication can involve hundreds, even thousands of small components that result in pressure losses. With this level of complexity it was important to validate the mathematical models with a component level test and then run an expensive verification of the combined systems. The result was a fairly inflexible solution that required a significant amount of engineering time both in the model construction and the requisite validation.



The use of Simcenter™ Flomaster™ software allows a significant streamlining of the development process. From the very beginning, creating the fluid model is easy and intuitive. Model construction is done by simply adding predefined components to the schematic and connecting them as designed. When it is necessary to make changes to the model it is as simple as replacing components, changing connections, or editing in the Simcenter Flomaster model, instead of updating input data or even changing the coding in the Excel calculation sheet.

It is also possible to reduce the design time needed to size distribution lines for required flow rates. In wind turbine gearboxes there is always more than one flow path that requires fluid flow.

These paths are rarely naturally equal with regards to pressure drop, so it is necessary to implement restrictions in some lines to ensure the flow is balanced. In Simcenter Flomaster, the Flow Balancing functionality allows this to be done directly instead of through a time consuming iterative design process. For each flow path, it is possible to simply set the desired flow rate in the part that needs to be sized, such as an orifice, pipe, or valve, and the software calculates the required size.

The use of Simcenter Flomaster also meant the possibility of a simple and quick validation of the models since each component comes with validation data and results. This means that unlike in-house programming where each time design changes require code changes and thus new validation, model updates

in Simcenter Flomaster don't require new validation. And with the ability to determine flow rates and pressures anywhere in the model, the verification of the system against test data from flow measuring devices under realistic circumstances was easy.

For ZF Wind Power, the use of Simcenter Flomaster leads to an efficient way of developing oil distribution networks for their wind turbine gearboxes. It allows for the reduction in design resources and validation effort giving a good return on investment. The use of Simcenter Flomaster within ZF Wind Power has resulted in an efficient way of developing oil distribution networks for wind turbine gearboxes. ■

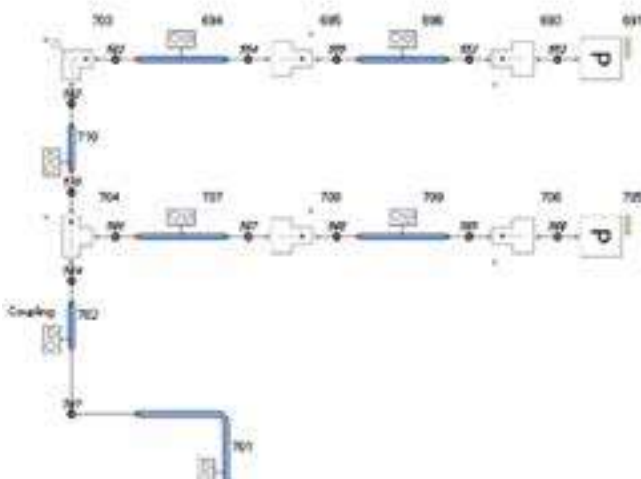
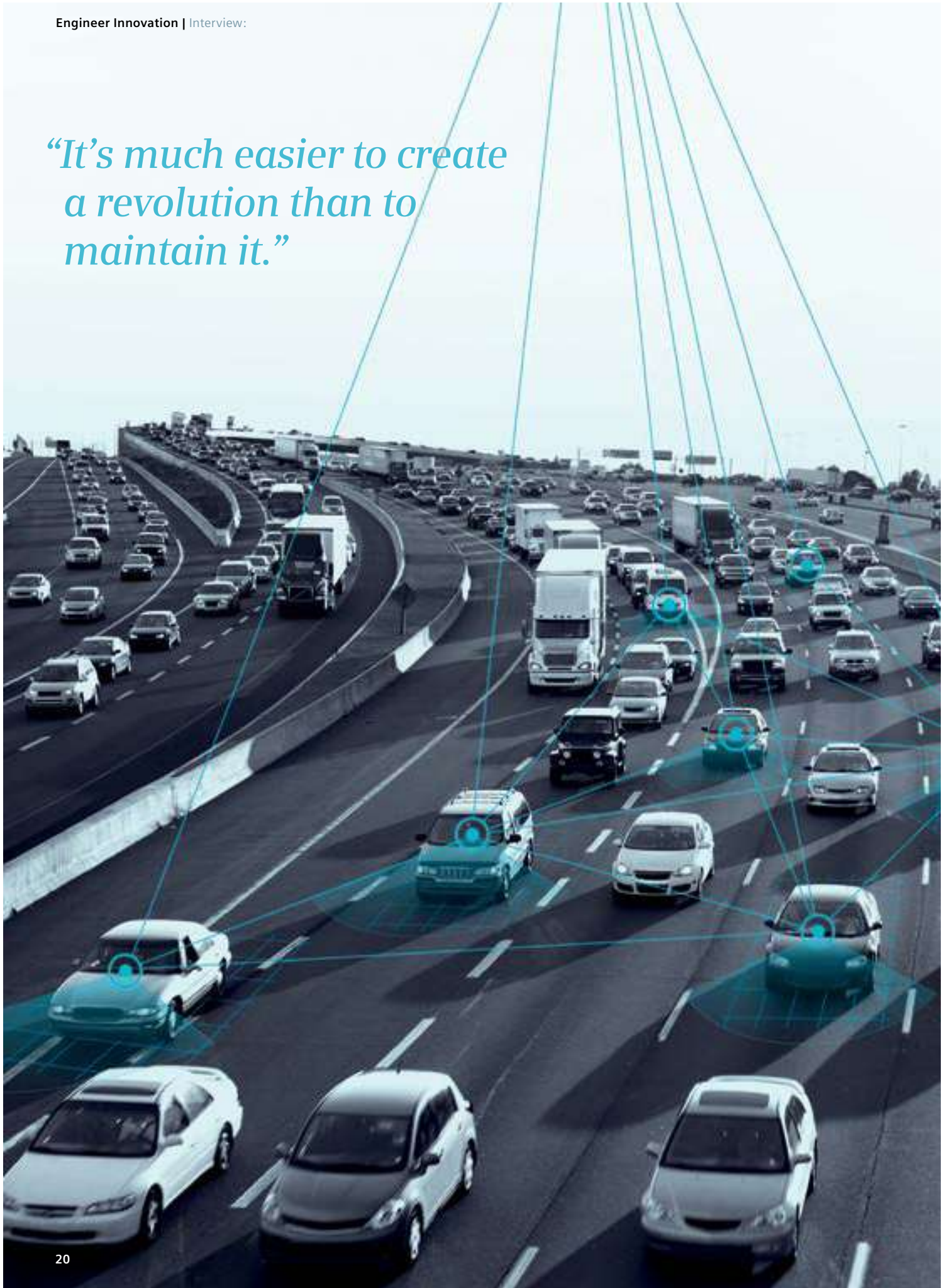

Figure 2. Simcenter Flomaster oil distribution model



Figure 3. Flow meter verification testing

“It’s much easier to create a revolution than to maintain it.”



Interview

The 2019 Reality Check: Autonomous Driving

Even though electric vehicles are taking off, truly autonomous vehicles still need to be manufactured. We spoke to two industry insiders about the progress being made and the challenges that lie ahead.

If 2018 was the year of big dreams (and in certain cases, some back-tracking), 2019 looks to be the year of the reality check. Yes, we have the technology to make electric vehicles (EVs) work and yes we have the collective *esprit* (to borrow from the French) to go down the path of self-driving vehicles. What we don't have is all the nitty-gritty technical details, and the enormous social and infrastructural implications ironed out.

So roll up your sleeves, according to industry experts, Joe Barkai, author and Chairman SAE Connected Cars; and our colleague Jan van den Oetelaar we still have a ways to go when it comes to autonomous vehicles.

S: What are the trends affecting automotive original equipment manufacturers (OEMs) at the moment?

Jan van den Oetelaar: What we see is that the OEMs are strapped with an enormous game-changer today. There are a number of big mega trends. Anything to do with digitalization is number one. Second is anything related to urbanization, which is a big challenge. Then we have the

personalization that people want today, and last but not least, there is a fourth, sustainability, which overall is something that is challenging.

The OEMs have translated these trends into something called the CASE subjects: connected, automated, shared and electrified. They are trying to gather information around these four themes, and set up an ecosystem to make this big change a success.

S: What about electric vehicles? It seems they are becoming a reality.

Van den Oetelaar: Electrification is clearly an element that the OEMs are conquering. If we are able to get the right natural resources together as well as our connection to the energy grid, we are going to be able to move forward. The next step after that is anything related to autonomous driving.

S: How close are we to the goal of autonomous driving?

Joe Barkai: First of all, it's a progression. I always like to say, 'It's not a revolution, it's an evolution'. Many people in the industry are not looking at this in the right way. Right now, autonomous vehicle features, as sophisticated as they are, are heralded as cool features. That is really not important because there's too little business or societal value in that. I see a tremendous value in cars that provide services for people with disabilities, for the elderly, or for a

working single parent who needs to get the children to soccer practice or ballet class.

S: What is the next step for autonomous vehicles?

Van den Oetelaar: It is not about what we know and what we can do, it is about understanding what are the elements that we don't know and understanding the risk associated with it. This is something that we are trying to help our customer base with. From a technical perspective, this is the core of the equation today.

S: Who is driving this? Are the traditional OEMs taking the lead?

Van den Oetelaar: Vehicle manufacturers are one part of the new ecosystem, but we are seeing new industries pop up and hook into this new ecosystem. This is going to be an integral part of it. A good example is telematics. A second example is cloud infrastructure – anything having to do with the Internet of Things (IoT).

S: Are we as a society ready for autonomous vehicles?

Van den Oetelaar: If we start to develop vehicles that are automated and electrified and we start to operate them under different circumstances, the big questions that come up are: 'What is the effect on the occupant? What are people perceiving inside? And what are people perceiving outside? Do bikers and pedestrians feel reassured?'

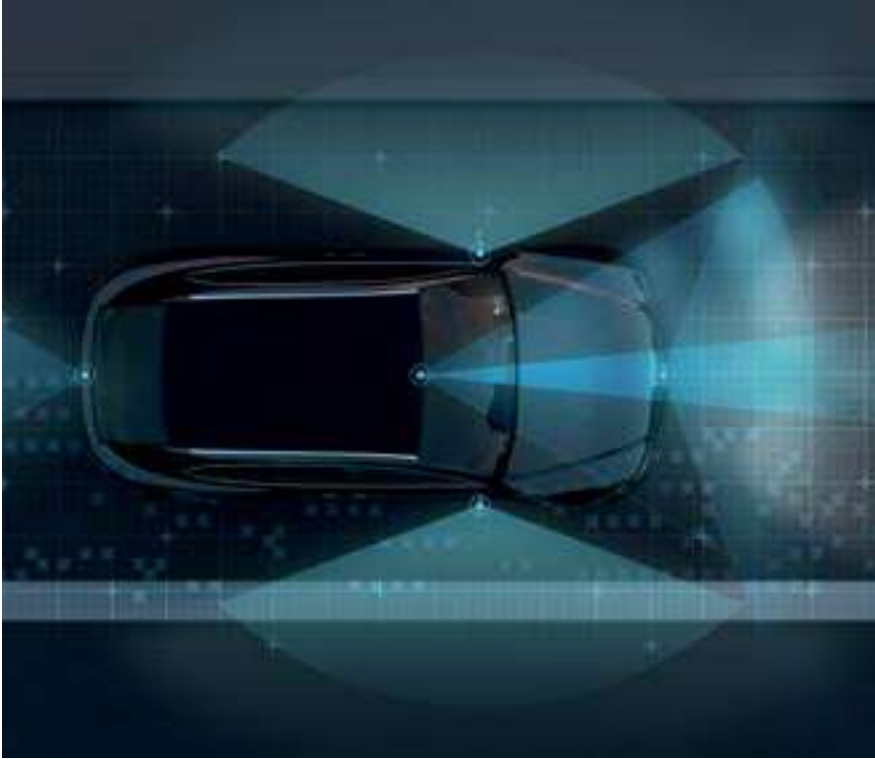

Everyone is convinced that safety remains one of the key aspects. So our focus on the outside of the vehicle is in reality to improve occupant safety because occupant safety is the ultimate goal.

S: What role does TASS International, a Siemens Business play in EV development?

Van den Oetelaar: Our platform Simcenter Prescan is able to connect to all types of autonomous elements. We can hook up to existing OEM simulation work, but also the new entrants in this market who will be able to help us build a good overview and enhance the richness of the scenario database. We need this to evaluate the complete ecosystem.

Without getting too technical, what we bring to the table is the connection of the vehicle to the full world around it. It is the eyes and ears of the vehicles. This is what we have in our portfolio today and this is what we are recognized for on a global level.

S: As an industry expert, what is your biggest challenge?

Van den Oetelaar: If you ask most CEOs in automotive, it is very clearly safety. Safety is number one. OEMs can

insure themselves against recalls and technical things that you can solve. What you can't insure today is your brand image and the way that OEMs handle safety is key to keeping their brand image upright.

S: What are the safety challenges that need to be addressed of EVs?

Van den Oetelaar: If you look at safety, then what we tend to look at is physical safety – the crash tests that we do. Today, if you look at an automated vehicle, we tend to look at functional safety.

Safety has a number of components. There is the component of technology. There is the component of connectivity, where we have to understand how the connectivity works and how we are able to master the connectivity under the safety flag. And last but not least, there is functional safety, which includes legislation. The big question is how we can make sure that the technology and legislation side work hand in hand.

S: Creating proper autonomous driving legislation seems to be a huge challenge. What is the real status today?

Van den Oetelaar: We are working

together with a number of governments, road authorities and other agencies that drive these types of developments forward. What we see is a great openness to use new simulation tools to provide insights into the effects of certain elements, like how the vehicle is designed and how it operates in a certain environment.

S: What still needs to happen?

Van den Oetelaar: The road authorities would like to see a vehicle that has a natural driving behavior. An automated vehicle that would stop at a crossing and not drive off smoothly whenever there is a space available would lead to irritation from other road users.

Today, people do not understand why an automated vehicle or self-driving vehicle doesn't behave exactly the way that they would drive the vehicle themselves. This is something that we have to learn.

We are in discussions with some road authorities to not only allow a vehicle to go on the road, but to go one step further and make the vehicle pass a driving license. The self-driving cars will have to apply for a driving license so they really operate in a naturalistic way in a normal environment.

There are enormous amounts of current regulations and at the same time these regulations don't cover what we are trying to validate for an autonomous vehicle today. That is a big challenge.

Barkai: Safety issues are certainly important and today we are not convinced that we have enough test miles accumulated to prove that we have covered all the possible self-driving scenarios. There are interim steps to take. For instance, we should invest more in autonomous trucks and truck platooning systems, where a human drives the first truck. Today we are looking at autonomous cars primarily from a technology innovation point of view and not from a broad adoption point of view. We will forgive a human for making a mistake, we will not forgive a machine for making a mistake.

S: How are autonomous vehicles tested?

Van den Oetelaar: We have been assigned to become the simulation partner of a big test track in the United States, ACM. It is the biggest test track globally where you can validate interconnectivity and interoperability between vehicles. It is not just the vehicle on its own: the question is 'how do I (as a self-driving vehicle) get along with my peers who are on the road as well?'

Autonomous vehicles will be released on these types of test tracks. We currently have relationships like this with companies and governments in the US, Europe and Asia. What we see is that there is a big willingness to share information to get up to a level where we jointly can see and access what the risk is to make sure that we have a satisfying product with little to no safety risks.

S: How will autonomous vehicles pass industry regulations?

Van den Oetelaar: Today if you bring a vehicle to market, you have to homologate your vehicle. It means it will have to comply with a number of different rules that in a lot of cases are standard. There are some variations for different countries. Once you have met these regulations, your vehicle is released and it means that it functions according to the legislation out there.

Anything that goes beyond is the responsibility of the driver. So a lot of systems in your vehicle are not operating when you switch the key. You have to push the button. That means you as a driver are responsible for the function of the vehicle.

This is not the case for automated vehicles. If we go for automated vehicles, we have to push a lot of buttons and this (functionality) is installed automatically. This drives the fact that we have to work on new legislation. It goes beyond the fact whether the steering wheel is round or it's a joystick. I don't think that is the question anymore. The question is how can we make the actions or interactions with the rest of the traffic – how can we make that safe and robust for all the use cases out there.

S: Besides safety, what other areas need attention?

Joe Barkai: We need more conversation about interoperability of systems and business models. For example, there's not enough conversation about one city municipality that develops a smart infrastructure and another that develops smart energy management and how they work together. On the same trajectory, we don't have enough interoperability standards and there's no regulation saying you have to use a specific standard. We're very early in the process.

S: Reality check: when will we see true autonomous vehicles on public roads?

Barkai: We are looking at ten or more years before we have safe fully autonomous vehicles that we can summon anytime, anywhere and they will take us anywhere. But there are many opportunities until we get there so it's not like we have to wait seven years or ten years to enjoy the benefits of autonomous vehicles in semi-limited locations and applications.

A key role in providing value in autonomous cars is not only the automated driving itself or the autonomous navigation, it's about providing an ecosystem that allows you to deliver a service. Until we have a fully developed ecosystem of partners

working together, the progress will be much faster on the technology side and much slower in the adoption side. I want to change the balance to drive adoption on the usage side faster so that we see incremental value and incremental progress even before we have Level 5 automation.

S: What comes after autonomous vehicles?

Van den Oetelaar: If we look today at how technology is being implemented and applied, we are seeing that automotive is driving a lot of the innovation. At the same time, there are lots of use cases and industries that have similar needs and that can benefit from the same technology. Whether it is autonomous ships, whether it is AGVs (Automate Guided Vehicles) that run in factories that will drive a complete reformation of the factory concept, whether it is anything that is airborne, like drones or aircraft...We are seeing lots of different areas where the technology that is being developed can be duplicated and replicated. We feel that this is something that is buzzing on the market. As a Siemens company, this is a good thing. Actually, it is great. It is not just about automotive; it is about society as a whole. ■



Joe Barkai, author and chairman SAE Connected Cars



Jan van den Oetelaar, CEO TASS International, a Siemens Business



Electra Meccanica

Electric automotive manufacturer uses Simcenter and NX to move from concept to finished product in 18 months



Revolutionizing productivity

For nearly 50 years Intermeccanica made custom sports cars. Then owner Henry Reisner met Jerry Kroll, a passionate environmentalist who also happened to love sports cars. The two decided to fuse their passions. They sketched an idea for a three-wheeled, single-commuter electric vehicle. The goal was to marry their love of driving with their mission to save the planet and transform mobility in the process.

The result was a new company called Electra Meccanica, located in Vancouver, British Columbia, Canada, and a new car called the SOLO. Reisner, co-founder and president, and Kroll, co-founder, chairman and chief executive officer (CEO), knew they had to move fast with their concept, so they transformed a napkin sketch into a digital NX™ software design in a matter of days. Then they used Simcenter™ software to optimize and validate the performance of the all-electric SOLO. Finally, using NX CAM and 3D printing, Electra Meccanica built its dream car.

It took just 18 months to go from concept and digitalization to a road-ready vehicle.

Now they're working with Chinese manufacturer Zongshen to produce 75,000 SOLOs in three years.

"There truly is a revolution in productivity because of the Siemens software that we're using," says Kroll.

To top it all off, Electra Meccanica was uplisted to the NASDAQ Capital Market (under the ticker symbols SOLO/ SOLOW) in August 2018. To mark the occasion, Kroll rang the NASDAQ opening bell on August 30.

Persistence pays off

Kroll met Reisner by walking into the Inter Meccanica office one day: "Jerry was an adamant environmentalist, convinced that electrification of vehicles was the future 15 years ago," says Reisner. "I didn't share that vision and on several occasions ushered Jerry out of my shop so I could get some work done. But his persistence knows no bounds, so he kept coming back and we became friends. When he brought the concept of a single-passenger, three-wheeled commuter electric vehicle to me, I thought it was a brilliant idea."

“The three wheel thing isn’t anything that you say, ‘Oh, it’s got to be three wheels,’” says Kroll. “It’s just the best package for light weighting the vehicle. If you run the analysis on the thing, you’re eliminating 25 percent of the weight, which you don’t need. And you’re in a single-person vehicle. As you’re driving, you turn the wheel and you don’t even know there’s just one wheel back there. It’s sublime.”

Kroll points out that 83 percent of people commute by themselves so a single seater makes an awful lot of sense. He says it also provides the best driving experience.

“I’ve spent the last 25 years in motorsports representing Indy 500 winners and all kinds of different drivers and all kinds of different series, and I’ve been racing cars myself for five years,” says Kroll. “My preference is a single-seater car and there’s a reason for that: It’s the purest form of the driving experience.

“The SOLO offers the single-seater experience for the road for \$15,500 (US). When you drive it, you get it. It’s like before you had a smart phone, you’d say, ‘Why do I need one of those?’ But once you have it you can’t live without it. This is a brilliant product and I predict we’re going sell as many SOLOs as Apple is selling iPhones.”

The benefit of using a single interface

Rich Hoyle, who is the principal engineer at Aligned CAE, was brought on in September 2015 as a direct contractor to Electra Meccanica. He worked on suspension and chassis design and general modeling and simulation for the SOLO vehicle.

“If you look at a vehicle development program, this was extremely rapid,” says Hoyle. “When I became involved in the project in September 2015, basically there had been some rudimentary surfacing done. We had the 2D sketch and the wheelbase to find the defined track, and that was pretty much it.

“One of the advantages of using NX and the fully integrated Simcenter™ 3D software is we’re not jumping between different tools for different activities so we can do our design and simulation work all in a single interface. We weren’t worrying about transferring data from tool A to tool B. That was a big benefit to us.”



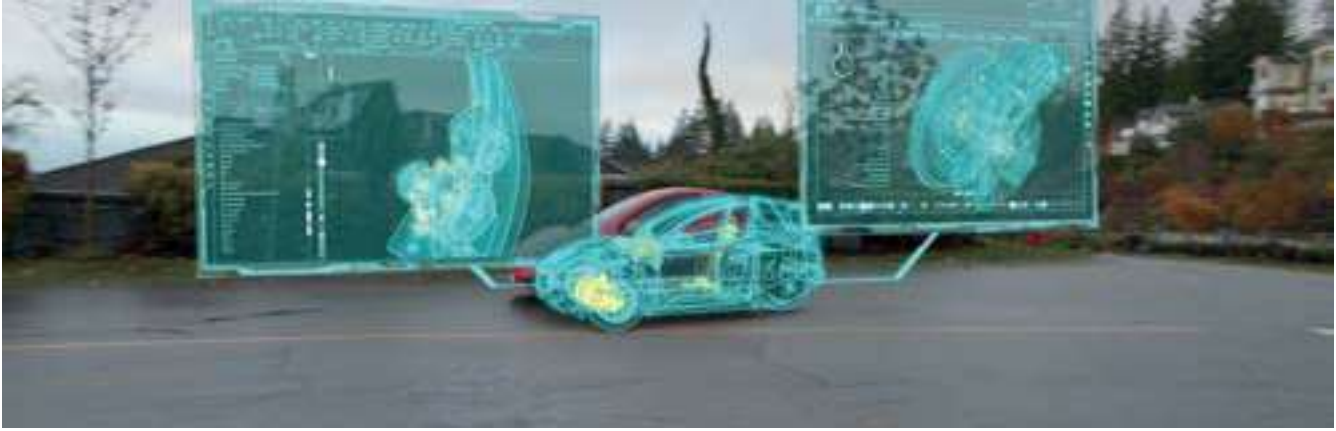

“There truly is a revolution in productivity because of the Siemens software that we’re using.”

Jerry Kroll
Chief executive officer
Electra Meccanica Vehicles Corp.

Hoyle was used to working in the iterative design and computer-aided design (CAD) part of the process, which is largely disconnected from the simulation part of the process.

“With Simcenter 3D, we have a direct parametric link back to the CAD data all in the one GUI, so that means that we can analyze the design, work out how we remove this, reduce some mass here, go back into the design, iterate it with two clicks, and we have updated results,” says Hoyle. “Simcenter 3D is very powerful for rapid design development.”

Design for manufacturing

The fundamental vehicle design is completed so now Electra Meccanica is focusing on the manufacturing design. The firm is looking at the tooling processes so they can start considering drafts for body panels, and updating the design so they can produce this vehicle in volume.

“Using the NX tools for analyzing the formability draft and those types of issues is very helpful to us,” says Hoyle.

Zongshen is also using NX as the primary tool for the design so they are able to take the design, alter it slightly for high-

volume production and look at all the different molding/forming requirements they have for their mass-volume production.

“We have a constant design loop with our partners in China, who are going to be mass producing the vehicle, and they’re using all the different tools of NX as well as the CAE tools,” says Hoyle. “The fact we’re both on the same page with the tools that we’re using certainly makes the design process a lot easier and the communication a lot smoother.”

Getting to market faster

“The world is changing and we have two strains of companies that are manufacturing, and what we’re looking at is a totally different way of thinking,” says Hoyle. “The smaller companies have smaller budgets but they have more nimble teams. What they’re looking to do is get tools that enable them to achieve engineering excellence on small budgets with small teams, and tools like NX and Simcenter allow them to do that.”

In the past, simulation has been used for prevalidation of design before going to testing. The tools have evolved so now a manufacturer is able to start looking at preprocessing a design, getting as close as they can to being prepared for the test.

For the composite materials of the chassis, for example, Electra Meccanica used the Simcenter 3D Laminate Composites solution to look at various layups for the skins of the materials and body panels. It is a powerful tool, notes Hoyle, for trying different methodologies for lay-up and also optimizing material usage and distributing layups in different areas of the vehicle, all inside of the Simcenter 3D environment.



“When we looked at the suspension architecture, we used the Simcenter 3D motion tools to evaluate turning radius, roll centers, that type of stuff in the suspension design,” says Hoyle. “Those tools helped us visualize easily and quickly, and make rapid design iterations based on our turning circle requirements, which are obviously extremely tight since we want it to be a great city car so it has to get into tight spots.

“We use NX CAM and the NX 3D printing functionality for prototype development, and generate our parametric toolpaths here, which is another benefit to keeping everything inside of one system. We can have a CAD model that we’ve done in NX that’s parametric and is easily adjustable, and have a fully parametric one linked into our CAM software, which is in NX and can then go straight to our CNC machining center.

“The key benefit is having the design and simulation all inside one environment, and being able to modify a design and automatically update a simulation result

to see the cause and effect. As far as a tangible result, it enables us to iterate faster and get to market quicker, which is really the goal here.”

Shutting down the last gas station

“If you look at the numbers, there’s not a lot of competition in electric cars,” says Kroll. “There’s still a bazillion gas cars being built. That’s our competition and we’re trying to encourage as many of those gas car companies as possible to stop doing that and join us in building electric cars.

“The electric car is like the internet and a gas car is like a fax machine. Once you drive it you get the difference. The only difference is that fax paper wasn’t killing the planet and gas is. Less than 10 percent of the cars that are being sold today are electric. We’ve got a long way to go and the faster that we can inspire the big auto manufacturers, in addition to Tesla and GM, to start building all their cars without fossil fuels, the better. That’s really what this company’s mission is: To shut down the last gas station.” ■

“Simcenter 3D is very powerful for rapid design development.”

Rich Hoyle
Principal engineer





TREK

Trek Bicycle

Design space exploration enables optimization of bicycle aerodynamics and ride quality

Designing second-to-none bicycles

Trek Bicycle Corporation is an American manufacturer of bicycles, cycling components, accessories and apparel whose founders set out in 1976 to make “the best bicycles the world had ever seen.” The company’s vision was grounded on two principles: the product would be of the highest-quality craftsmanship, and it would bring the joy of cycling to a broader audience. Propelled by this vision, Trek is now one of the largest bicycle manufacturers in the world, employing almost 2,000 people and producing about 1.5 million road, mountain and city bikes each year.

While not everyone may think of bicycles as high-tech products, bike design involves complex physics and frequently unknown interactions among multiple physical phenomena. A key challenge is the trade-off between aerodynamic efficiency optimization and comfort and ride quality. Aerodynamic bikes are

traditionally known for their harsh rides and poor handling, Trek notes.

Attacking this challenge in developing its Madone road bike, Trek applied computational fluid dynamics (CFD) together with finite element analysis (FEA) to set a new benchmark for aerodynamics in a bicycle that’s also comfortable to ride and handles smoothly. Aerodynamic performance is most influenced by the geometry of a bicycle’s tubular frame. Aerodynamic tube shapes typically have high aspect ratios, where the depth of the tube is two to three times greater than the width. This provides for a very aerodynamic profile, but the large section properties resist bending, like an I-beam, creating a harsh and unforgiving ride. To overcome this conflict, Trek engineers hit on the solution of separating the aerodynamics from the comfort with a tube-in-tube construction. This new way of designing a frame allowed them to design an outer tube structure optimized for aerodynamics with Kammtail Virtual Foil (KVF) tube shapes – an aerodynamic airfoil design that originated in the auto racing world. Meanwhile, an inner tube structure was optimized for ride comfort by FEA-based tuning of deflection and vertical compliance. These are the properties by which the frame cushions the rider from vibration and road surface irregularities.

Automating workflows for bicycle design

A few years ago, Trek engineers began seeking a tool to automate their search for optimized frame designs. They needed a solution that would be compatible with their existing computer-aided engineering (CAE) software – Simcenter STAR-CCM+ for CFD and Abaqus for FEA, as well as

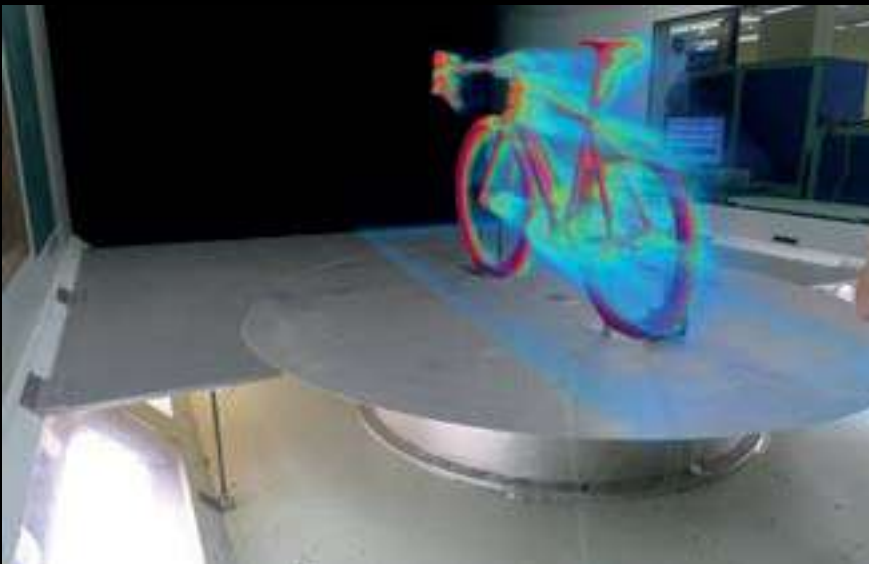

Figure 1: The Madone, the ultimate bike, a fusion of power, aerodynamics, ride quality and integration, was designed using Simcenter STAR-CCM+ and HEEDS

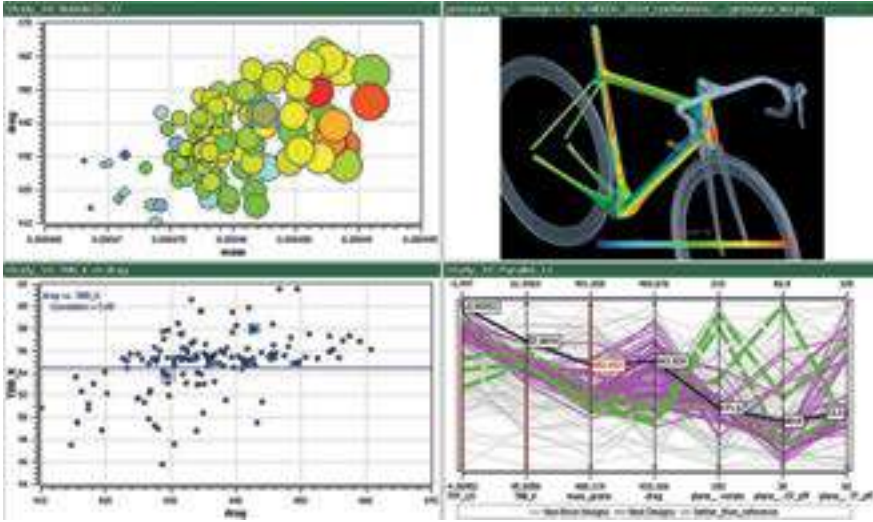

Figure 2: Bicycle design involves conflicting physics and unknown relationships among design variables: structurally optimized shape versus aerodynamically optimized shape; frame geometry, tube shape selection, composite construction; rider configurations and body position.

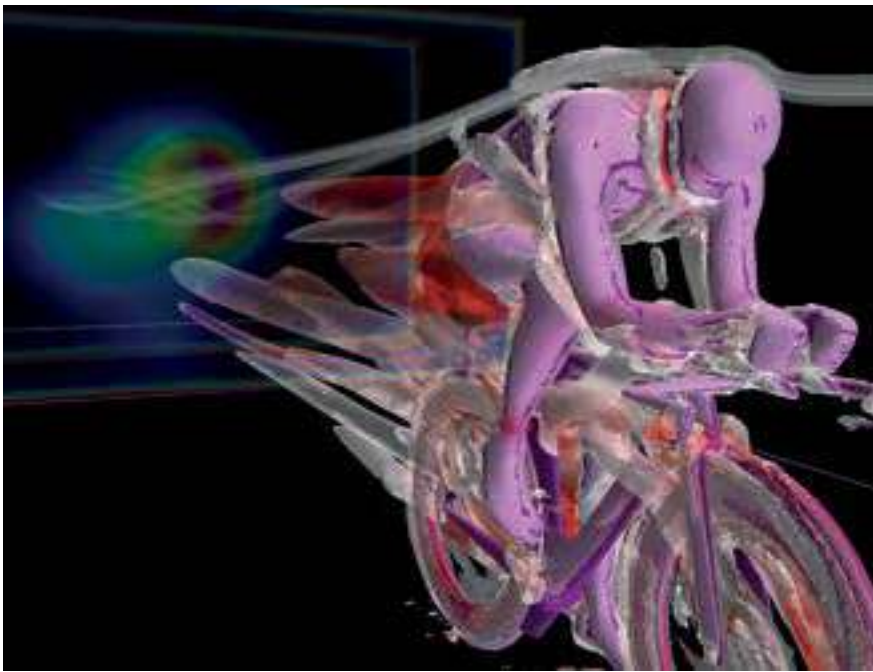

Figure 3: By making previously unknown correlations visible, multidisciplinary design optimization furthers understanding of the underlying physics, inspires dissection of problems from multiple angles, and encourages objective, data-driven conclusions and discoveries.

their computer-aided design (CAD) system, SolidWorks. They also wanted a tool that did not require a lot of time to set up a problem, processed a fast analysis, and provided the ability to visualize study results and graphically explore the design space. Lastly, because their CFD simulations tend to have long run times, they wanted a software that was cloud HPC (high-performance computing) ready.

The solution that best met their needs was HEEDS™ software, the design space exploration solution from Siemens PLM Software. HEEDS works by capturing and automating an engineer’s current design workflow, based on design and analysis tools of the user’s choice. The user defines design parameters and multidisciplinary design goals, then HEEDS automatically explores the design space to quickly identify feasible solutions that meet all the specified goals.

A proof-of-concept project proved the ability of HEEDS to handle multiple design objectives for bicycle frame optimization. The aim of this study was to minimize aerodynamic drag at the same time as frame mass, while satisfying constraints on both stiffness and baseline mass. Parameters were set to drive the cross-section sketch in a CAD model. Simcenter STAR-CCM+ was used to compute the frame drag, and FEA software was coupled to the process to calculate mass and stiffness of the frame. HEEDS generated multiple design iterations, numerically and graphically characterizing the key performance attributes of each iteration, and showing how each iteration balanced the trade-offs between mass, structure properties and aerodynamic drag.

“Facing substantially greater demand for computational resources, Trek turned to cloud computing, taking advantage of the availability of HEEDS on an HPC cloud platform.”

Minimizing the aerodynamic impact of water bottles

Analyzing the impact of water bottle placement on aerodynamics was required in order to discover a design that made the Madone the fastest bike under real-world conditions. The addition of down tube and seat tube water bottles impacts drag by creating additional pressure and disrupting airflow on the tube surfaces. To minimize these unfavorable drag impacts, HEEDS was used to explore optimal water bottle locations to minimize overall frame drag. In the starting CAD model, water bottles were mounted on the down tube and seat tube at arbitrary points on a prototype frame. Each bottle's original location was marked with respect to the center of the bottom bracket – the component that connects the crankset (chainset) to the bicycle and allows the crankset to rotate freely. HEEDS then iterated over new designs (new bottle positions), progressively adjusting the iteration input values according to the prior drag responses. After 140 iterations, the final result showed a 5.5 percent reduction in overall drag. In this study, the aggregate result showed the preference to place the seat tube bottle as low as possible toward the bottom bracket, while keeping its influence minimal on the down tube. The seat tube is an important area for determining overall bike drag and affects the bike's yawing ability, so keeping this tube as exposed as possible would minimize the drag penalty.

The most important benefit of HEEDS, Trek's engineers say, is what they call an ensemble-based analysis, wherein trends for achieving the objective become apparent once sufficient data are produced via design space exploration. This uncovers previously unknown correlations among design variables and performance attributes, as well as deepening engineers' insight into already known phenomena. Beyond furthering their understanding of the underlying physics of their designs, it also inspires them to look at problems from multiple viewpoints – indeed, the software sometimes discovers solutions that engineers hadn't thought of, as occurred in the water-bottle placement study. Because automated design space exploration reveals much more

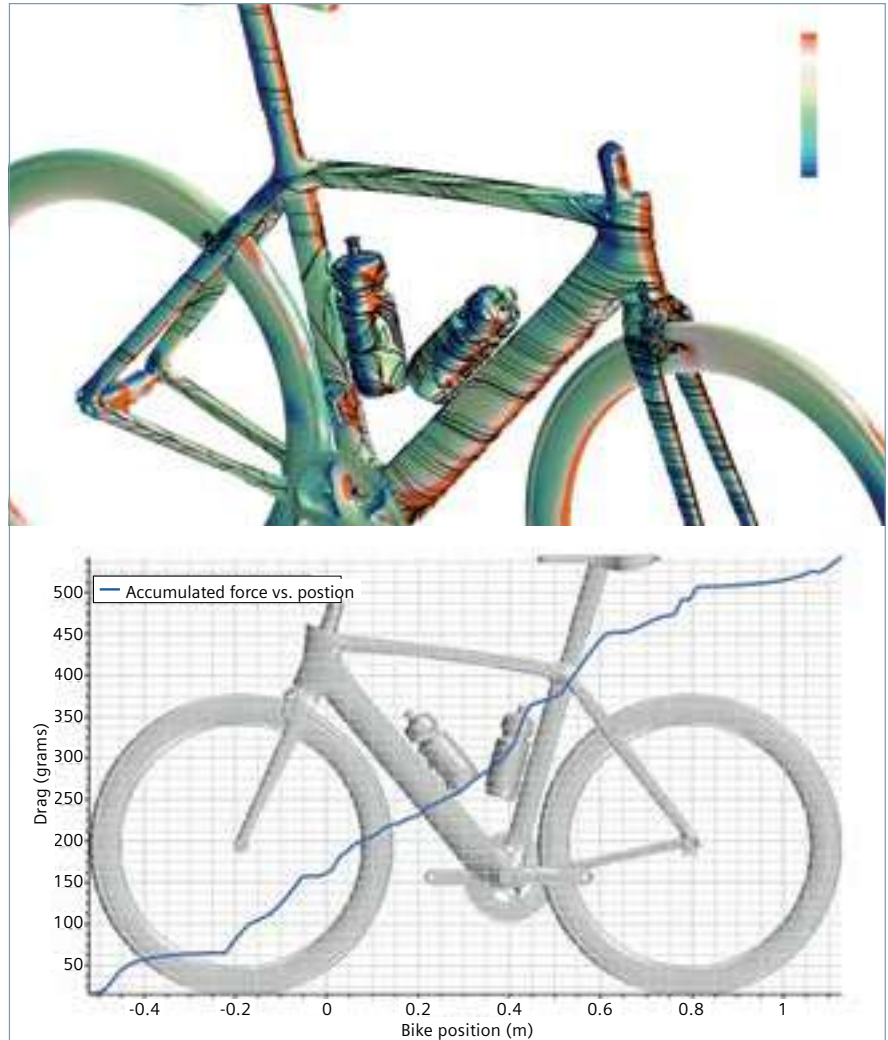

Figure 4: Impact of water bottles on surface pressure and surface flow (top) and accumulated drag force versus bike position (bottom).

information about a design than the limited number of iterations possible with sequential, manually executed analysis runs, Trek engineers say their conclusions tend to be more objective and data-driven than before.

Previously, when carrying out optimization manually – with CFD and FEA but without HEEDS – engineers would typically analyze 30 to 50 different design iterations for a given problem. Now, HEEDS makes it easy and practical to carry out 500 to 1,000 iterations in the same time or even less. This, in turn, created a new challenge: substantially greater demand for computational resources. Trek turned to cloud computing, taking advantage of the availability of HEEDS on ScaleX, the cloud simulation and HPC platform from Rescale. Trek benchmarked a typical Simcenter STAR-CCM+ case involving a

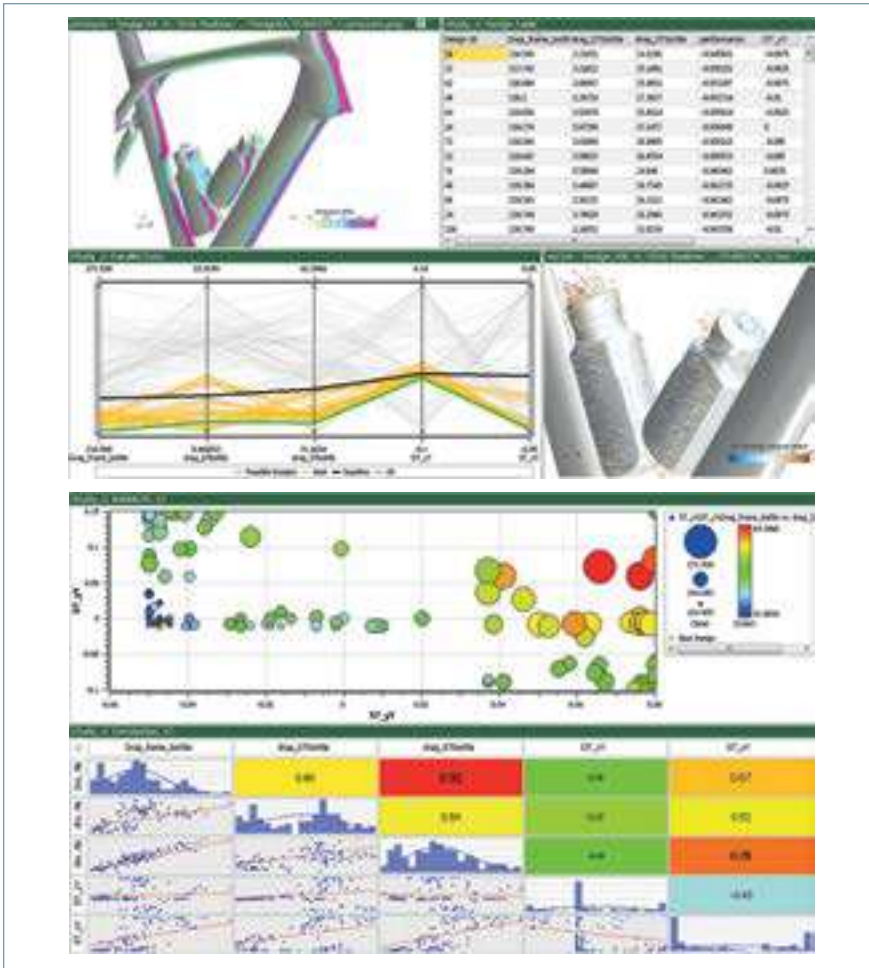

Figure 5: HEEDS output for water bottle placement optimization.

bike in a wind tunnel model with about 12 million cells. Run time on an old, on-premise HPC device with 12 cores was six hours to extract one drag number. On the ScaleX cloud platform using 64 cores, this fell dramatically, to 42 minutes. Using 96 cores, run time was further compressed to 32 minutes. With 128 cores, run time was just 22 minutes. Instead of waiting almost a full workday for an answer, cloud HPC lets analysts extract an answer in close to real time, file the report and proceed to the next step in their project.

Four-person drafting: identifying optimal rider assembly configuration for a given wind condition

In a project demonstrating the value of cloud HPC, Trek studied a situation in cycling races where riders group closely together in what’s called a pace line, to conserve energy by reducing wind drag. Using Simcenter STAR-CCM+ and HEEDS in a coupled analysis, engineers ran a simulation on ScaleX to study varying bicycle drafting methods. The case modeled four cyclists in the computational domain, each with X-Y and lateral coordinates. The objective was to identify the optimal rider assembly configuration for a given wind condition. To begin, the CFD case was

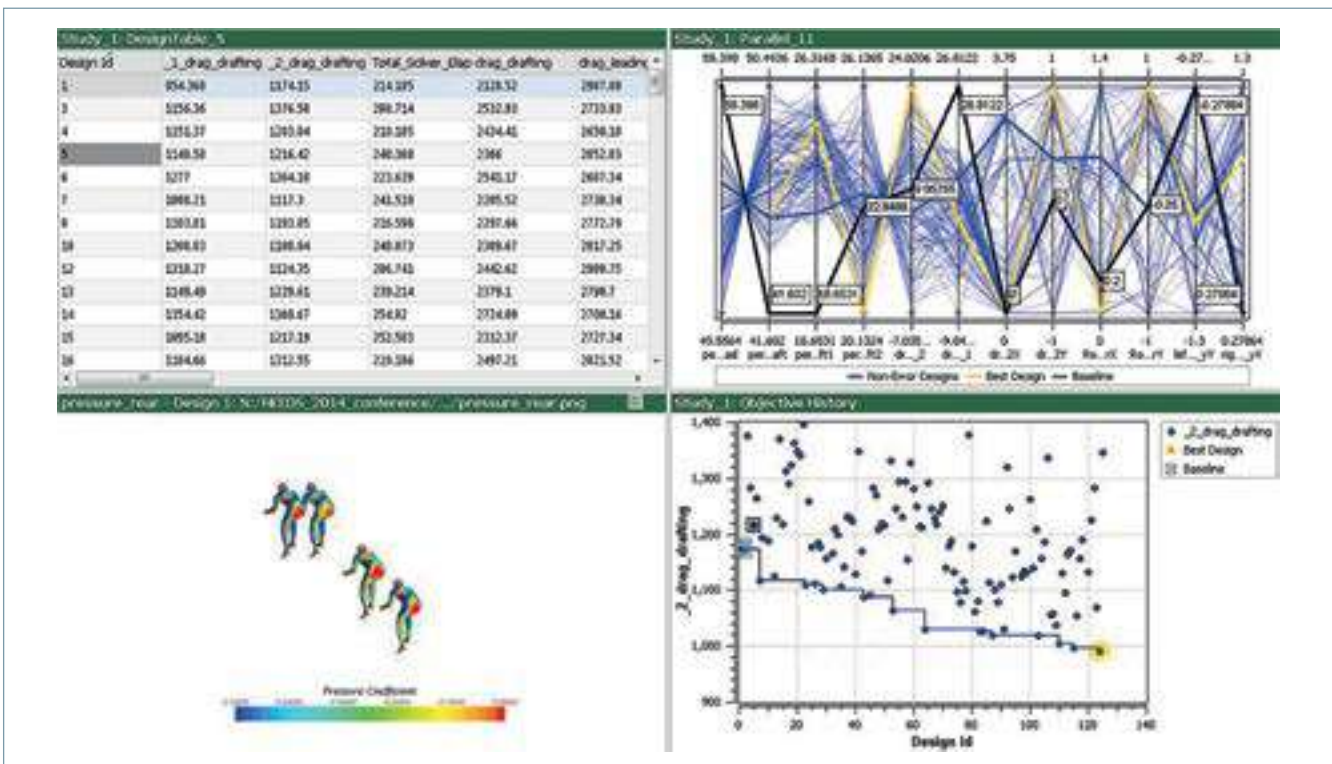

Figure 6: HEEDS output for the optimization of a four-person drafting configuration.

set up in Simcenter STAR-CCM+. Using an optimization workflow predefined in the ScaleX environment, Simcenter STAR-CCM+ and HEEDS were coupled in one simulation, and the job was set to run on 64 high-performance cores. The simulation used a steady-state Reynolds-averaged Navier-Stokes (RANS) turbulence model to study aerodynamic impact among several riders. As the HEEDS iterations executed, the analyst could watch each cyclist moving around within the specified domain, with HEEDS exploring and making visible the trends and relationships among variables, and showing the drag reduction converging to a given value. In this way, HEEDS

allowed Trek to fully explore the experiment to make informed decisions about the best drafting techniques for competitive cycling.

A giant leap forward

Design space exploration and cloud computing are enabling Trek's R&D processes to take giant leaps forward. What excites the company most is the prospect of its analysts, design engineers and industrial engineers all being able to brainstorm together more effectively and rapidly than ever, thanks to the design insights available within HEEDS and the quick turnaround times of cloud HPC. ■

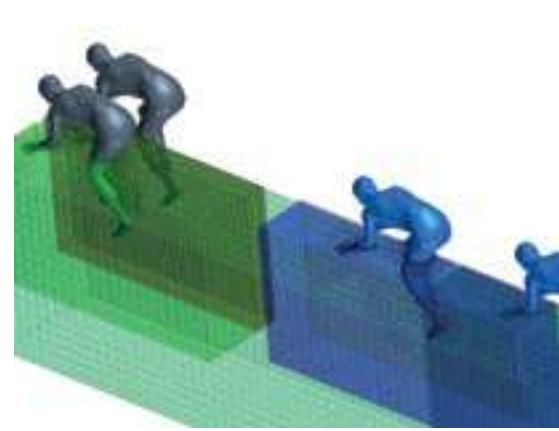

Figure 7: Bicycle pace-line drafting simulation: geometry and overset mesh setup in Simcenter STAR-CCM+.

“HEEDS uncovers previously unknown correlations among design variables and performance attributes, as well as deepening engineers’ insight into already known phenomena.”

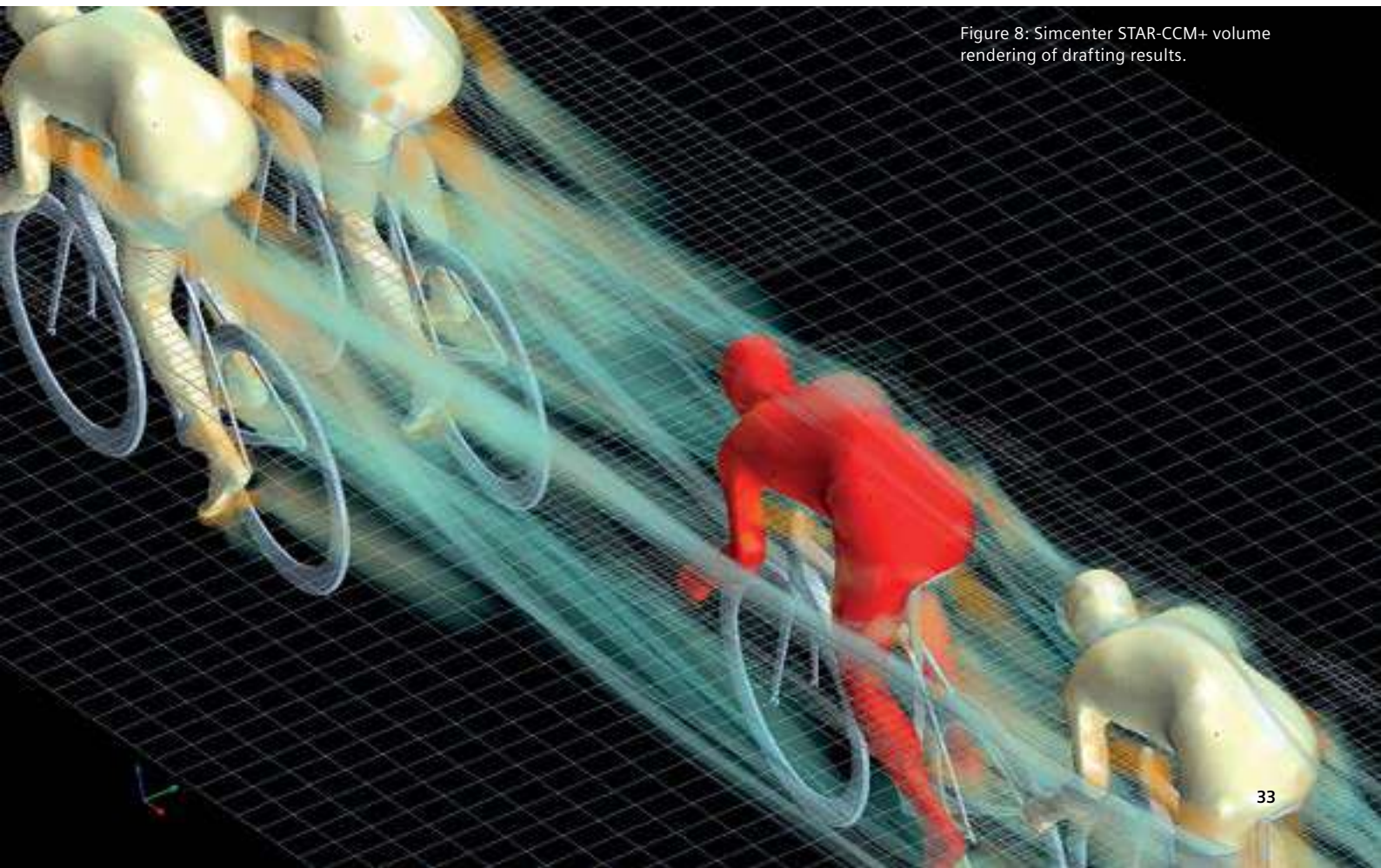

Figure 8: Simcenter STAR-CCM+ volume rendering of drafting results.

The Pure Perfection of Electromagnetic Suspension in Induction Furnaces

Dr. Vitaly Peysakhovich, President, Elmag Corporation

An induction furnace is an electrical furnace in which the heat is applied by induction heating of metal. This is a clean, energy-efficient and well-controllable melting process compared to most other means of metal melting.

Induction furnaces with cold crucibles (CCIF) are broadly used for the melting of super-pure metals and alloys as they reduce load contamination compared to traditional furnaces with the ceramic crucible. This is due to the water cooling system employed.

However in some applications, the very small contamination that happens at contact of the molten metal with cold copper is unacceptable. A higher level of purity requires full elimination of molten metal contact with cold crucible walls in the process of melting. The goal can be reached by holding molten metal in suspensive condition in the process of melting. Practically, the electromagnetic (EM) field of the coils in this furnace have to not only create the heat for induction melting, they also need to provide EM suspension of melted metal.

Each induction melting furnace creates some meniscus of molten metal in the process of melting.

As a rule, the meniscus volume is very small and does not have any influence on the melting process. In the full suspension case, the molten meniscus volume has to be commensurable with the full load volume of furnace, ideally, 100 percent of it. Creation of such furnaces is an independent problem that requires the development of a calculation method that has to take into consideration a combination of closely bound electromagnetic, thermal, hydrostatic and electro-dynamic processes. The objective of the article is to show such a calculation method.

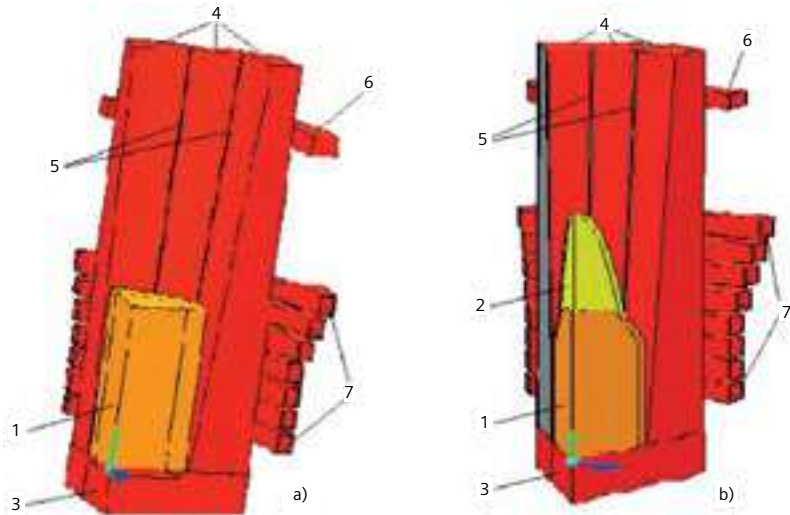

Figure 1: 3D models of furnaces with cold crucible. a) solid load, 12- sections crucible, 1/4 of furnace; b) partially molten load, 24- sections crucible, 1/8 of furnace; -solid load, 2-molten load, 3-crucible bottom plate, 4-crucible sections, 5-gaps between sections, 6-flux ring, 7-induction coil. Note: water cooling system of cold crucibles is not shown

The description of this developed method is done on a concrete example:

- Load: material is titanium, solid load diameter is 76 mm, initial load height is 100 mm, temperatures (degrees Celsius) (initial is 20, melting is minus 1660, overheating is minus 1800), latent heat fusion is 419 kJ/kg.
- Cold crucible: material is copper, minimum initial diameters are from 80 to 140 mm, height is 273 mm, number of sections are 12 and 24, gaps between sections are 0.5 mm.
- Induction coil (combination of cylindrical and conical groups of turns): material is copper, minimum inner diameter is 166 mm, height is 160 mm
- Electrical parameters: frequency is 10,000 Hz, nominal inverter power is 100 kW, upper limit of coil voltage is 1000 Volts, upper limit of coil current Amps.

Let's recall how the cold crucible furnaces works. Figure 2 shows an

example of magnetic field distribution in an induction furnace with cold crucible.

Magnetic flux created by an induction coil can be conditionally divided into three parts:

- Coil flux leakage;
- Flux along the crucible's sections ; and
- Flux that passes to the load through crucible sections.

The ratios between the three parts of magnetic flow determine the efficiency of the furnace. The more that is part of load magnetic flow, the higher the efficiency.

The number of sections has a very strong influence on the cold crucible as well as on all the furnace parameters. Comparing simulation results between crucibles with 12 and 24 sections shows that useful magnetic flux and the electrical efficiency of the furnace with the 24-section crucible is significantly higher than in the furnace with the 12-section crucible. The

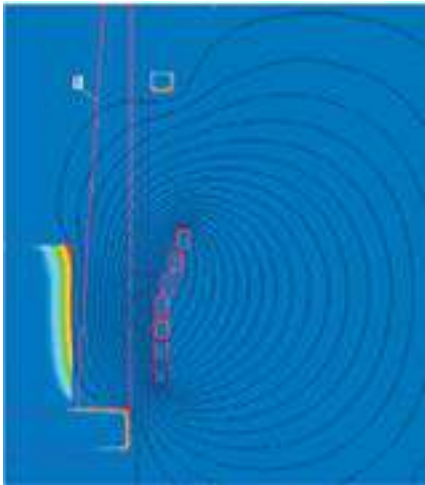

Figure 2: Magnetic field and current in cold crucible furnace with solid load. 1-cold crucible profile.

additional advantage of the 24-section crucible is also due to a more uniform distribution of the magnetic field along the load azimuth perimeter. This significantly improves stability of the molten load meniscus.

Figure 3 shows distribution of currents induced by furnace coil in two variants: solid and combination of solid/ molten loads.

The furnace magnetic field induces current, and therefore heating in both the solid and molten load. At the same time, there are very big differences between the two kinds of loads: drastically different shape and material properties. In the process of one furnace heat, during load transfer from a solid billet to melt meniscus, there are cardinal changes of furnace load parameters. As was previously stated, the furnace must simultaneously melt the load and suspend the molten metal. The satisfaction of both conditions requires complex calculations. Figure 4 shows the workflow diagram developed for the calculations.

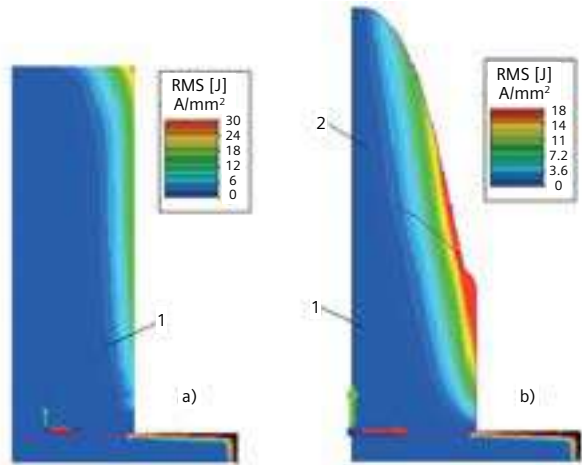

Figure 3: Current density distribution in load. 1-solid load, 2-molten load.

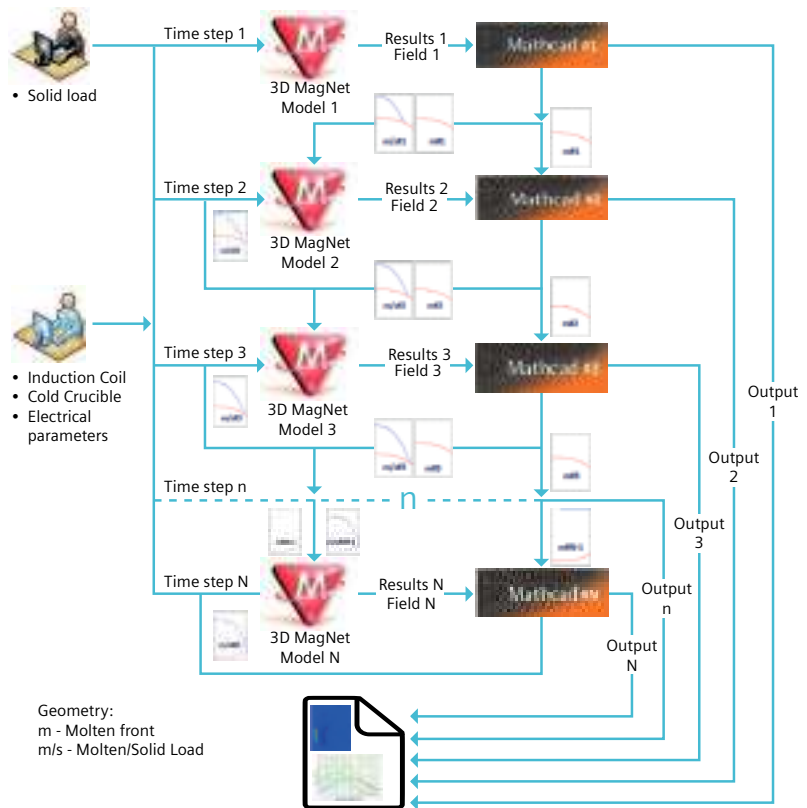

Figure 4: Calculation workflow diagram

The total time for the melt, starting from the activation of the furnace to the actual metal casting, has to be divided into time steps.

Each time step consists of independent electromagnetic block made of a Simcenter™ MAGNET™ mode. The post-processing of all simulation data will be done in Mathcad. The input in the Simcenter MAGNET model comes from the output of the previous step. The Simcenter MAGNET models make electromagnetic calculations and transfer the results to MCD program. The MCD program uses the results for thermal, hydrostatic and electrodynamic

calculations. Calculation results of the steps are transferred, as input to the next step of the workflow and to a common workflow output.

The first step is the time between the start of the heating process and the actual melting of the top surface of the load. It differs from other time steps because it requires a separate solid load calculation method. The rest is calculated by dividing the remaining time by the number of time steps without the first. Taking in to consideration the shape of the cold crucible segments, requires full 3D simulations of the electromagnetic fields in Simcenter MAGNET. An example of cold crucible meshing is shown in Figure 5.

The results of Simcenter MAGNET simulation after each step are transferred to Mathcad postprocessing blocks. The blocks are responsible for providing the following operations:

- Calculation of temperature and energy as in solid so in molten parts of load;
- Determination of load meniscus shape; and
- Meniscus EM stabilization.

The results of each time step are integral parameters and shape of the molten load. The results are transferred to the next time step input.

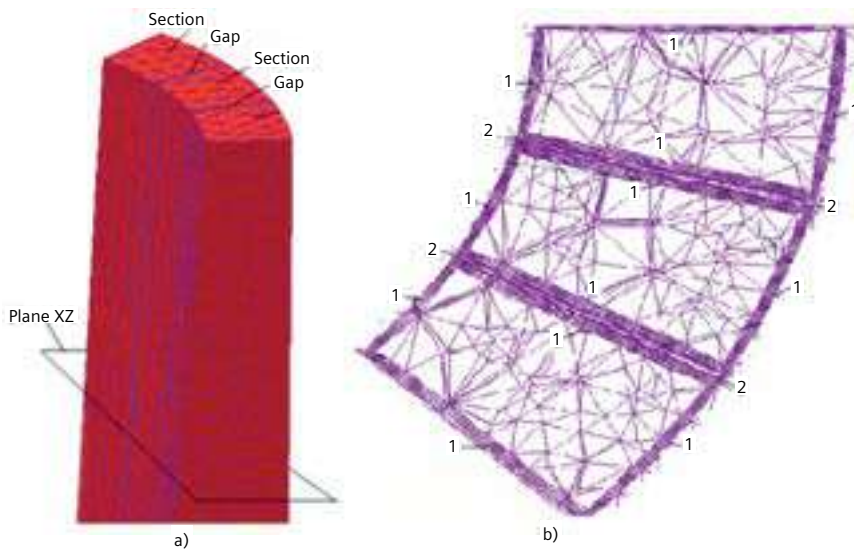

Figure 5: Cold crucible meshing. a) section surfaces b) plane "XZ" cross section. 1- section mesh layers (3x0.3mm), 2-gaps mesh layers (4x0.1 mm)

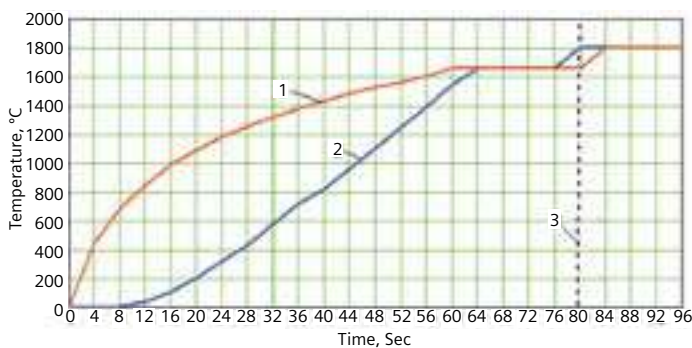

Figure 6: Determination of initial molten load front at one of time step 1-surface T at 50mm from load bottom, 2-axis T at 98 mm from load bottom, 3-time of load axis melt.

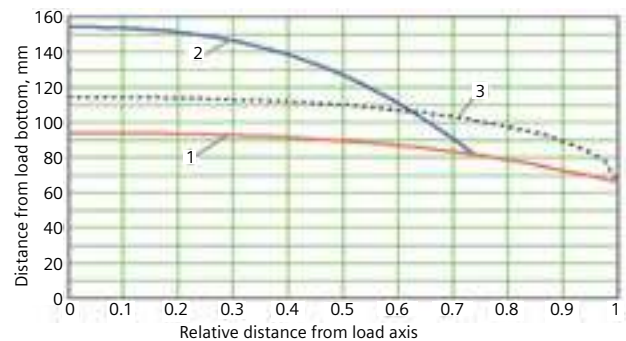

Figure 7: A profile of partially molten load after 80 sec (step2). 1-load solid part, 2-molten load after iteration, 3-molten load before iteration

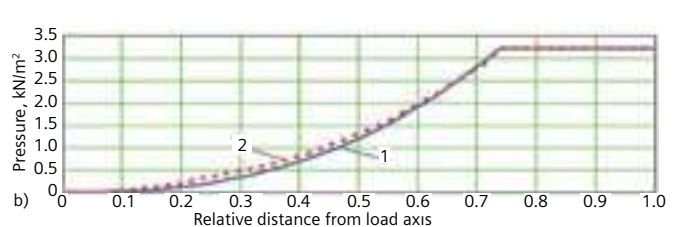
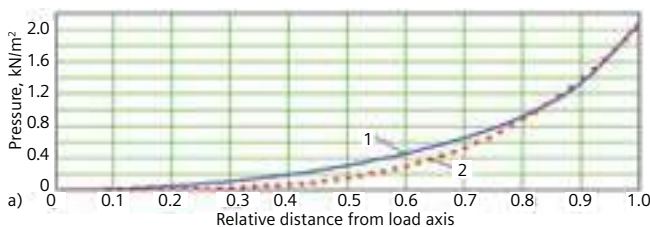

Figure 8: Hydraulic and EM pressure on meniscus surface. 1-hydraulic pressure, 2-EM pressure

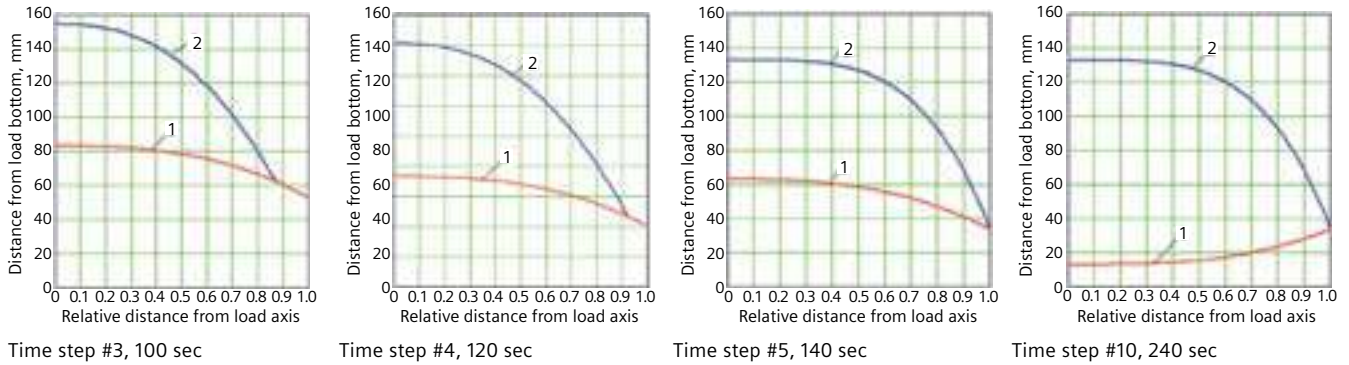

Figure 9: Load profile variation during a furnace heat. 1-solid load, 2-molten load

showing variation of load temperature(T) with time.

The graph is fixing the molten load front location. That gives the necessary data for load meniscus calculations. Figure 7 shows the procedure of meniscus calculation. The calculation of the shape of the load meniscus requires an iterative approach, so the meniscus data is passing, as feedback, into its own Simcenter MAGNET model. Nominally, the load meniscus calculation comes to finding out a molten load shape with hydraulic pressure that is equal to the electromagnetic pressure of the coil magnetic field.

The third profile is an ellipsoid of second order with a bottom diameter equal to the solid load diameter and volume of the molten load. The Simcenter MAGNET block has the distribution of the magnetic field in the zone of molten load, particularly, in the zone of outer diameter of the molten load. The intensity of the magnetic field in this zone can be used to determine the initial meniscus height and its bottom diameter (Figure 7, Curve 2).

Curve 2 in Figure 8 is incompatible with the electromagnetic pressure curve that Simcenter MAGNET produces (See Figure 8a). The two curves have a good coincidence on its ends, but not in the middle. There are two ways to improve compatibility of the curves: a) induction coil design; b) induction coil location.

The coil design method was used from the beginning, this design uses a combination of cylindrical and conical coil turns. This design showed satisfactory results in the initial stages. The curves on the Figure 8b show good agreement.

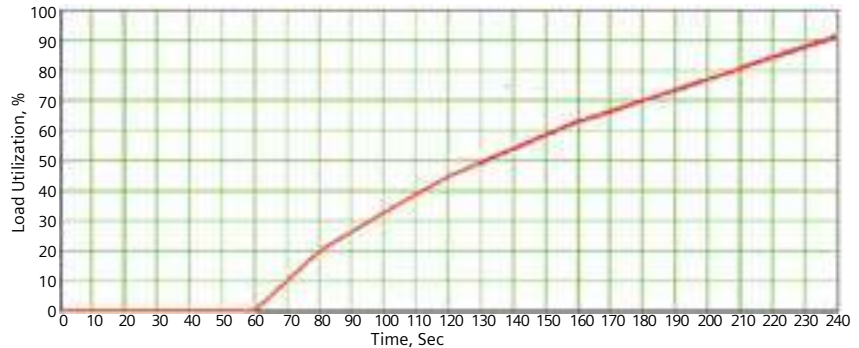

Figure 10: Furnace load utilization coefficient.

The coil location produced conflicting results: it is impossible to find one optimal location of coil for all variants. The design decision was made to move the induction coil in the process from the top of the furnace heat to the bottom.

The change can be done synchronously with time steps or continually. This variant was explored and shows satisfactory results. Some examples of the load profiles calculations are shown in Figure 9.

The developed method efficiency can be defined by estimation of load level utilization of the furnace. The "Load Utilization (LU)" coefficient may be used for the goal. The LU coefficient is defined as a ratio between mass of molten load output and mass of furnace charge. As the Figure 10 shows, at the use of movable induction coil, the LU coefficient is more than 90 percent.

Conclusion

The represented method of the induction furnaces with the cold crucible calculation allows for the design of furnaces with minimal contact between the molten metal and the furnace crucible, which in return dramatically reduces the contamination of the load. ■



Photos courtesy of Hydro-Québec.

Hydro-Québec

Canadian energy provider uses Simcenter testing solutions to optimize power output



Addressing challenges of the 21st century

Generating and distributing energy in a more sustainable way is a major challenge in the 21st century. Hydro-Québec is a world-renowned power utility and a leading technological innovator. It aims to play a pivotal role in the transition to renewables and the decarbonization of electrical generation.

Hydro-Québec generates, transmits and distributes electricity. It is the largest power utility in Canada, and a major player in the global hydropower industry. It also operates a vast high-voltage transmission system. Its sole shareholder is the Québec provincial government.

Its mission is to provide customers with a high-quality power supply while contributing significantly to Québec's collective wealth. As a recognized leader in hydropower and large transmission systems, Hydro-Québec exports clean, renewable

power and commercializes its expertise and innovations in world markets.

Enable sustainable power generation

Hydro-Québec operates some 60 hydroelectric generating stations and is one of the largest hydroelectricity producers in the world. Nearly all of the electricity is generated using water. To support its objectives to deliver clean energy to customers across Québec and export markets, Hydro-Québec also relies on its research institute, the Quebec Electricity Research Institute (IREQ). IREQ is the largest electric utility research center in North America. Hydro-Québec invests a yearly average of \$100 million Canadian dollars (CAD) in its innovation projects.

The IREQ team is made up of approximately 500 people; a broad range of scientists, technicians, engineers and specialists. Their efforts make it possible to extend the service life of facilities, boost performance, optimize

the maintenance of equipment, support energy efficiency programs and improve customer service.

François Lafleur is a researcher who specializes in mechanics and vibration at the IREQ. The research projects Lafleur is involved in span multiple technology fields, from optimizing the maintenance intervals of large turbines and maximizing the power output of existing facilities, to finding ways to preserve the aquatic fauna in the vicinity of hydraulic-electric installations.

Testing for better planning

One of the objectives of the IREQ team is to optimize the maintenance of the large turbines used in hydroelectric power generation. Those turbines operate permanently, keeping the shutdown episodes that occur for research, maintenance or repair purposes to a minimum, ensuring continued energy delivery and full customer satisfaction. The goal is to space out planned inspections by a minimum of five years.

Using Simcenter testing solutions, Lafleur measures and analyzes the vibration levels of the turbines. A typical test campaign takes up to ten days to complete. Since some measurements cannot be performed when turbines are in use, the timing of tests depends on the grid needs. No tests are performed during the winter season when energy needs peak. In the spring or summer season, multidisciplinary IREQ researchers visit power-generation sites to perform extensive tests on idle turbines.



The objective of the tests is to evaluate turbine conditions to predict maintenance needs. Ultimately, the tests aim to improve the planning of maintenance intervals and minimize turbine downtime. To get full insights into turbine conditions, the team takes up to three days to instrument the power generation equipment with a panel of temperature, electromagnetic, acoustic and vibration sensors.

During a planned shutdown phase, Lafleur carries out tests to measure the cavitation erosion on turbine blades. He uses techniques such as impact testing, or more rarely shaker excitation, to measure the transmissibility functions between the blades and the lower guide. The results let him understand whether the erosion stayed within reasonable limits.

“Simcenter SCADAS Mobile and Simcenter SCADAS XS provide maximum flexibility. They can easily be brought to the most remote test sites to perform measurements in operating conditions.”

François Lafleur
Researcher
Hydro-Québec



Understanding the structural dynamics in operational conditions

To get full insight into the turbine's operating conditions, some tests are performed during operation. Lafleur carries out measurements to confirm that vibration levels do not exceed the regulatory norms and standards, or uses modal analysis to find out at which frequency the maximum level of vibration occurs in the turbine. Since excitation forces cannot be measured when the turbine is in operation, Lafleur relies on operational modal analysis (OMA) and operational deflection shape (ODS) techniques to understand the structural dynamics of the turbine. The ODS also helps him separate stator from rotor frequencies, while the OMA filters out electromagnetic harmonics from the structural modes.

Equipped with Simcenter™ SCADAS™ Mobile software or Simcenter SCADAS XS hardware, Lafleur performs measurements and a first assessment onsite before he brings the data back to the laboratory for further analysis. To Lafleur, the advantages of hardware like Simcenter SCADAS XS are obvious.

"Simcenter SCADAS Mobile and Simcenter SCADAS XS provide maximum flexibility," says Lafleur. "They can easily be brought to the most remote test sites to perform measurements in operating conditions. There I can carry out my measurements autonomously, even without a

connection to my laboratory's server. With Simcenter SCADAS Mobile and Simcenter SCADAS XS, I am confident I will obtain high-quality, well-conditioned data that I will be able to further analyze in the lab. The good quality of results is critical in my job as I have only limited access to the item under test.

"One advantage of Simcenter testing solutions is the seamless integration of the hardware and software. With the Simcenter™ Testlab™ software, I can prepare my test in the lab, for example, creating a basic geometry of the turbines with the diameters and the shapes, or prepare calculations on the complete synchronous and asynchronous frequency range. When onsite, I focus on measurements using Simcenter SCADAS Mobile as a throughput recorder. I am always certain of the precision and quality of the measured data that I will analyze later back in the laboratory."

The modularity of the solution also meets Lafleur's needs when it comes to laboratory analysis: "I can use the information coming from the same accelerometer to calculate multiple values, for example, speed and displacement. Since we adopted the Simcenter value-based licensing scheme, I can use tokens to perform the analysis I need, from an operational modal analysis to a sound intensity calculation. I also appreciate the project workflows in the software and the easy data documentation."

Multidisciplinary intelligence

With Simcenter Testlab software, Lafleur has access to a wealth of analysis tools to gain deeper insights into the data sets. He shares his findings with colleagues from the multidisciplinary team. For example, vibration measurements are correlated and compared with temperature and electromagnetic measurements. The IREQ investigations allow Hydro-Québec to implement innovative methods to reduce maintenance time and intervals so they only need to perform necessary maintenance using nonintrusive methods.

IREQ's multidisciplinary team works on projects that require them to find

intelligence in the data from various origins, and consolidate it to gain a deep understanding of a system's multi-physics behavior. The team carries out investigations to find out if the power output of a turbine could be increased from 70 to 120 percent without jeopardizing safety or reliability of the equipment, and with a minimal impact on the turbine's lifetime. Limitations to uprate are mostly linked to mechanical and thermomechanical stress on the generators. The multidisciplinary team combines its knowledge of the system to create intelligent models of the turbine generator system. Test data is widely used to validate assumptions on the complex models. Although this innovative approach is still being consolidated, it already yields astonishing results: a power increase in some generators of 15 to 20 percent.

Focusing on customer service

Hydro-Québec activities are not solely focused on power generation. The company also offers energy transmission and distribution to homes. Hydro-Québec's mission is to deliver a safe, reliable power supply and offer outstanding customer service. IREQ's researchers also support this objective with their projects.

Electromagnetic repulsion effects coming from electric wires can be the source of annoying noise and vibrations. Hydro-Québec seeks to reduce these effects inside homes and around distribution grids in the vicinity of settlements in order to improve the comfort of electricity users. Whenever a disturbance is reported, members of the IREQ team will come to the site to measure and characterize noise levels, using, for example, the compact and portable Simcenter SCADAS XS. They will analyze the situation and apply appropriate countermeasures, such as modifying the wire configuration or installing a noise-damping device in order to reduce noise levels and increase consumers' satisfaction with the energy delivery services.

Versatile tools for a multitasking team

Being involved in such diverse projects, it is no wonder that Lafleur appreciates the versatility of the Simcenter testing

solutions. He also appreciates the efficiency of the technical support offered by the Siemens team. By extracting the information nested in the high-quality data acquired with Simcenter SCADAS and fully exploiting the multiple analysis possibilities offered by Simcenter Testlab, Lafleur is able to gain invaluable insights into data sets, and work jointly with experts in other engineering disciplines to propose novel solutions to tackle current challenges. ■

“With Simcenter SCADAS Mobile and Simcenter SCADAS XS, I am confident I will obtain high-quality, well-conditioned data that I will be able to further analyze in the lab.”

François Lafleur
Researcher
Hydro-Québec





Figure 1: Airbus Helicopters H160 prototype

Airbus Helicopters

Helicopter manufacturer uses Simcenter Amesim to minimize time and costs for certifying airworthiness



Navigating the airworthiness certification process

Airbus Helicopters strives to provide the most efficient solutions to its customers who serve, protect, save lives and safely carry passengers in demanding environments. Its helicopters are in service across more than 150 countries, performing nearly every type of vertical flight task imaginable. The company's product line offers the full spectrum of rotary-wing aircraft solutions for civil, government, military, law enforcement and combined private/public uses.

To earn an airworthiness certificate issued by a national authority, Airbus Helicopters, like all other aircraft makers, must make sure its machines and systems comply with a long list of certification specifications. To obtain certification, key aircraft systems – such as hydraulics – must be carefully assessed. Systems must work under any flight conditions and ensure the safety of the pilots, crew and passengers in case of failure.

The thermal management of evaluating hydraulic circuits is part of

the check list. First, Airbus Helicopters has to assess the integration of the circuit in the aircraft zones with the thermal impact without exceeding maximum defined temperatures. Further, it has to be certified there is a well-designed and working hydraulic circuit that can support proper flight command functioning even in case of failures (leakage, pump failure, etc.).

Based on these observations, there are two common problems that engineers must consider: the first one is development time. Indeed, getting certified is a long process. The earlier Airbus Helicopters can obtain certification, the faster it can get to market and the more competitive it can be. The second is the cost of prototypes incurred by test campaigns. So time and cost are a big part of the challenge, and that is something Airbus Helicopters considers when putting together its development programs.

Predict and verify thermal-hydraulic system performance

Of course, Airbus Helicopters cannot even consider bypassing the prototype test phase, whether it is for the system or once the system is integrated into the helicopter. Nevertheless, there are means to assess and define the best system architectures early in the development cycle, as well as the thermal management of the full system based on the architecture definition analysis. Employing system simulation enables Airbus Helicopters to predict and evaluate the strategies to maintain the heat balance of an aircraft program.

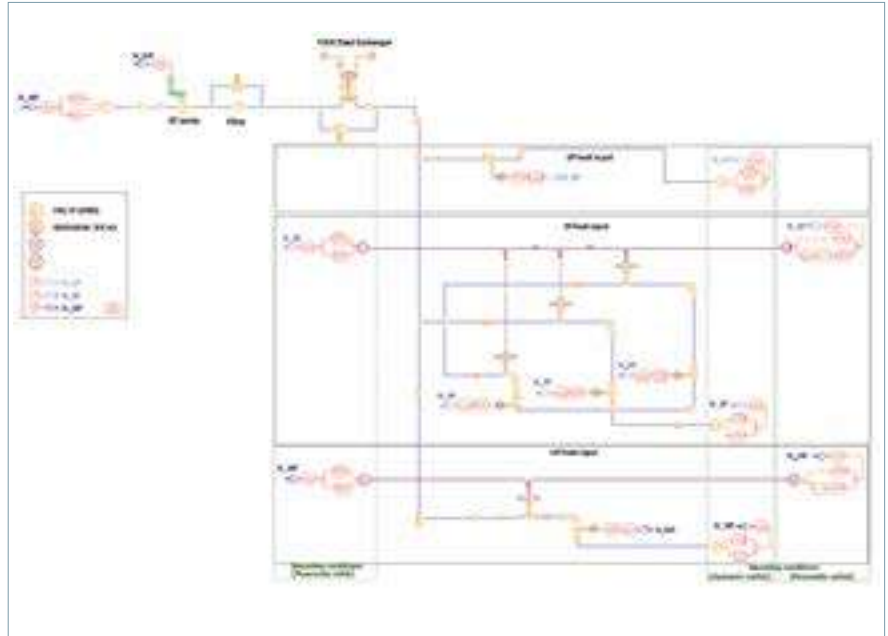

Figure 2: Simcenter Amesim thermal-hydraulic model

That's what Benoit Genot, hydraulic and flight control engineer, and Jean-Baptiste Lopez-Velasco, thermal management expert, and their teams decided to opt for when they were developing the Airbus Helicopters H160, its six-ton, new-generation, medium-sized rotorcraft. They leveraged Siemens' Simcenter Amesim software, part of the Simcenter™ portfolio, to accurately predict and verify the thermal-hydraulic system performance from early stage system sizing to fully integrated design. Their objective was to provide power to the main actuators installed on the helicopter flight domain while designing the hydraulic circuit. This is done under specific conditions, such as

“The whole circuit is linked to the main rotor actuators and the tail rotor actuator. For that we use Simcenter Amesim and its supercomponent capabilities to design some of our components.”

Benoit Genot
Hydraulic and flight control engineer
Airbus Helicopters

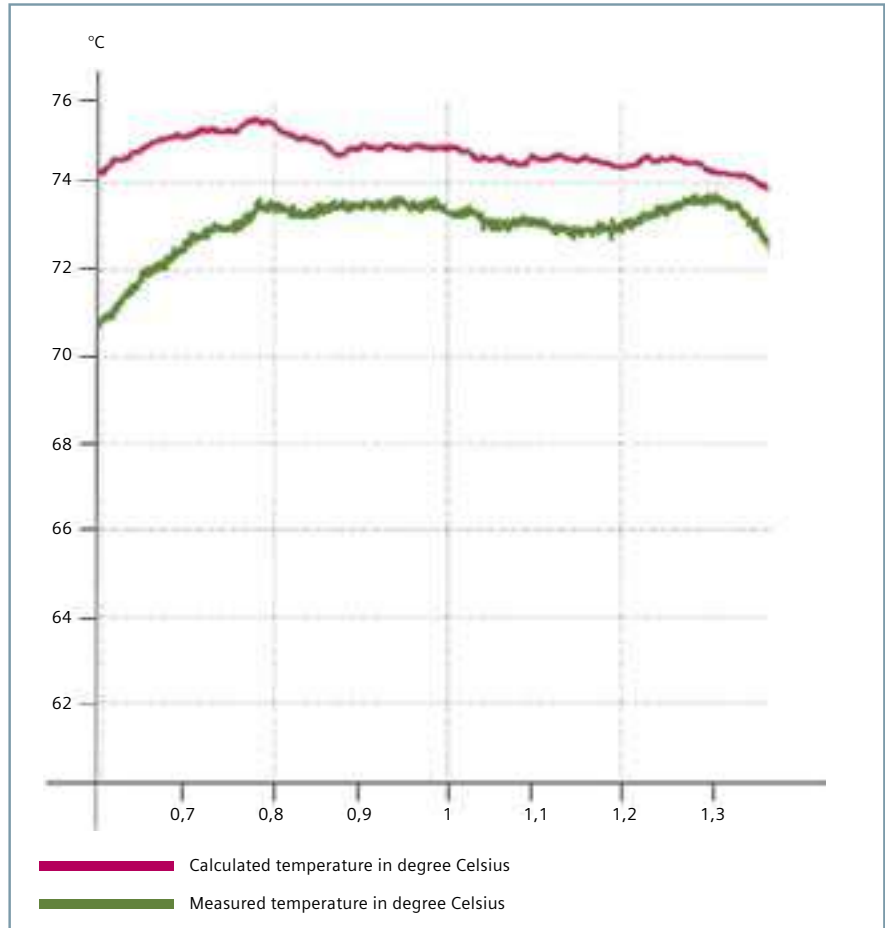

Figure 3: Comparison of stationary oil temperature: simulation vs. test

not exceeding temperature qualifications in hot conditions that can reach 50 degrees Celsius/122 Fahrenheit in outside air temperature.

“Our first objective was to design a rough architecture of a hydraulic circuit,” says Genot. “Each hydraulic power supply unit is composed of a tank, sensors (temperature/pressure/ fluid level), pumps and an emergency pump in case of a failure of one of the

main pumps. The whole circuit is linked to the main rotor actuators and the tail rotor actuator. For that we use Simcenter Amesim and its supercomponent capabilities to design some of our components.”

Secondly, it is crucial to understand the thermal influence of the hydraulic system on some of the helicopter parts. Indeed, once integrated into the helicopters, the hydraulic circuit mainly

“One of the questions that Simcenter Amesim helps us clarify is whether it is required to cool the fluid – in that case we need to use a heat exchanger.”

Jean-Baptiste Lopez-Velasco
Thermal management expert
Airbus Helicopters

covers the upper deck and main gearbox compartment. Around 90 percent of the hydraulic circuit is in this area. That is what Lopez-Velasco analyzes: "Based on the first scheme of the hydraulic system (modeled according to normal and failure cases conditions), we can start the thermal modeling using Simcenter Amesim," says Lopez-Velasco. "One of the questions that Simcenter Amesim helps us clarify is whether it is required to cool the fluid – in that case we need to use a heat exchanger. Then during the development there are several loops of calculation to refine the model."

Saving time on test campaigns

"Of course, tests remain mandatory for modeling construction and validation," says Lopez-Velasco. "Using Simcenter Amesim for system simulation enables us to anticipate model architecture so we can save time on the test campaigns because our model is already fine-tuned."

During test campaigns, Airbus Helicopters teams test the system in normal and failure modes. The measurements are done at different levels. They assess oil temperature, ambient temperature, velocities, pressures and flowrate. In addition to comparing the test and simulation result, the idea is also to refine the parameters of the simulation model based on the test results. The purpose is to make the model as true as possible to the physical version of the product.



Figure 4: Full dynamics test bench

In this case, Genot and Lopez-Velasco reached an accurate result because the difference between the Simcenter Amesim modeling and the test bench results only varied by +/-5 degrees Celsius while the aircraft was stationary.

"Modeling with Simcenter Amesim permits us to anticipate the design and architecture freeze of the hydraulics systems (routing, tank, heat exchanger) to secure the development cost and planning," says Genot.

In the future, Genot and Lopez-Velasco plan to study different weather cases, work on transient calculations (not only for stationary analyses) and integrate a real-time platform with Simcenter Amesim. ■



Figure 5: Hydraulic actuator test bench

“Modeling with Simcenter Amesim permits us to anticipate the design and architecture freeze of the hydraulics systems (routing, tank, heat exchanger) to secure the development cost and planning.”

Benoit Genot
Hydraulic and flight control engineer
Airbus Helicopters

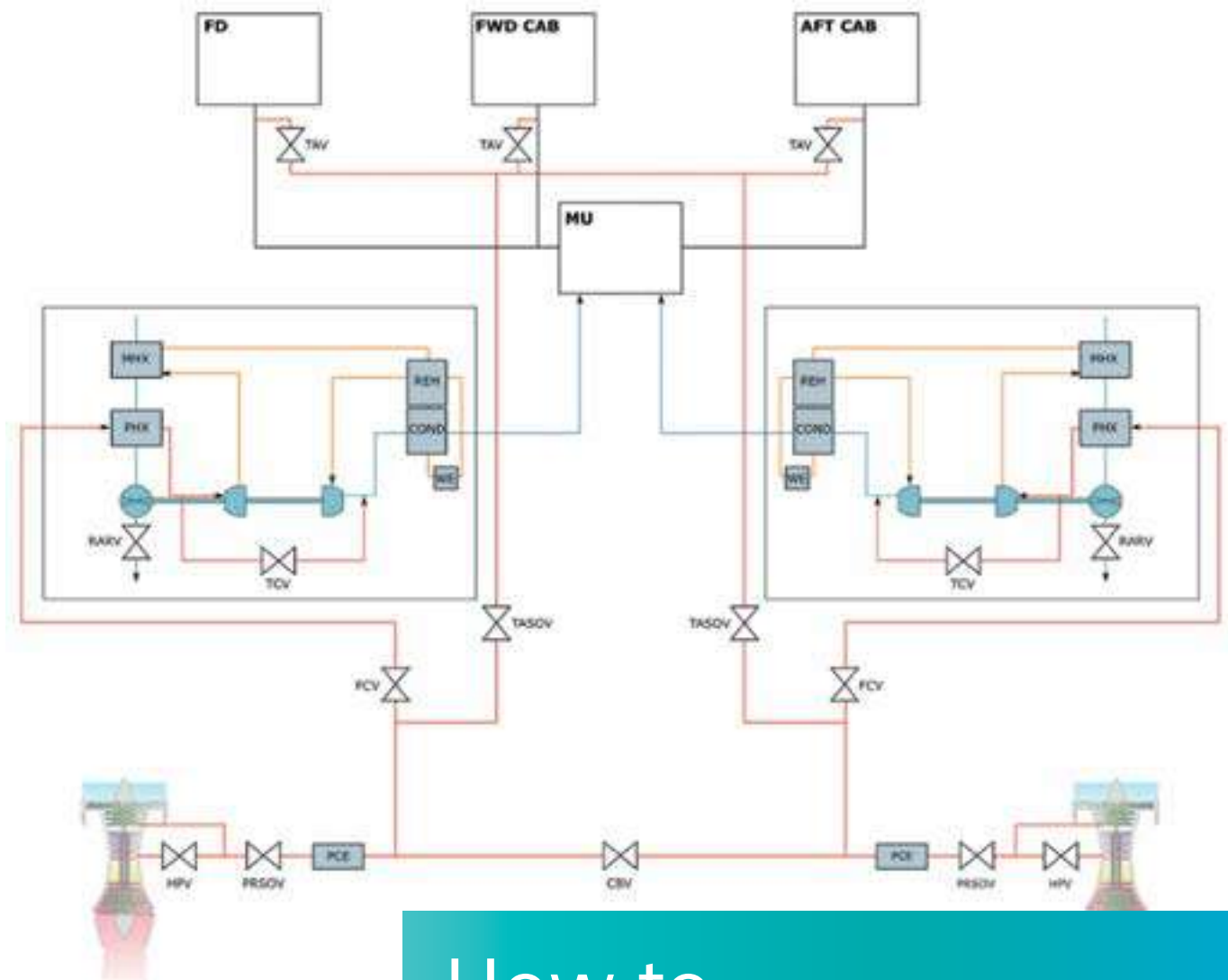

How to...

Assess aircraft cabin cooling sizing with Simcenter Amesim
 By Federico Cappuzzo, Simcenter Amesim product manager

Addressing environmental control systems design challenges

According to the certification specifications for large civil airplanes (such as FAR-25 or JAR/CS-25), aircraft environmental control systems (ECS) must ensure adequate cabin conditions for passenger safety. For instance, crew and passengers must receive enough fresh air, free of hazardous concentration of gases, and pressurized cabin compartments must provide a pressure altitude of no more than 8000 feet (ft). On top of that,

aircraft manufacturers equip the ECS to provide an optimal temperature for passenger comfort during the flight.

Another requirement expressed by airlines concerns the so-called “pull-down” or cabin cooling case. Here, aircraft manufacturers are requested to demonstrate that the aircraft on the ground on a hot day is able to reach a temperature lower than 27 degrees Celsius (80 degrees Fahrenheit) in less than 30 minutes. This shall be achieved using the auxiliary power unit (APU) as

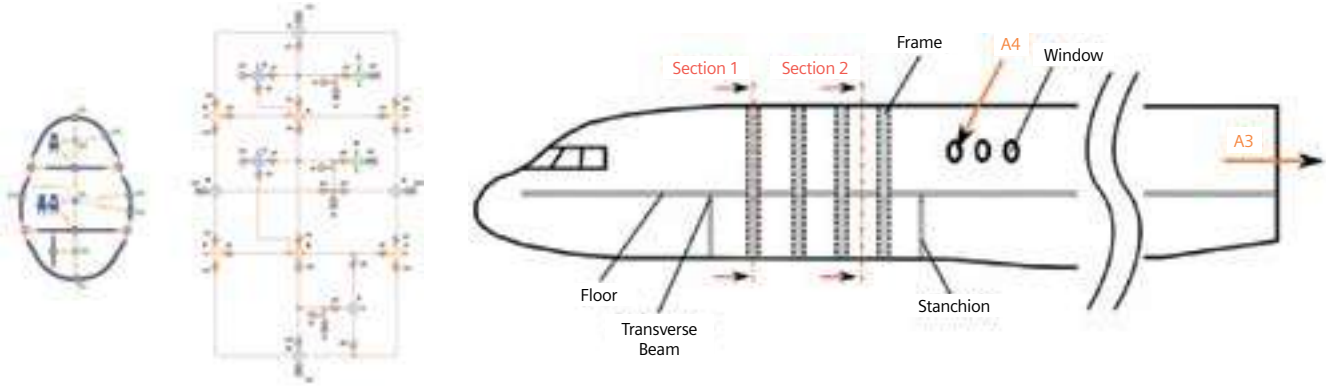

a power source, with an initial cabin temperature after heat soak of 45°C (113°F) and no passengers aboard. This requirement has a direct impact on the aircraft turnaround time, hence the aircraft operating cost, as the cooling down time delays the aircraft's full operability.

From an engineering perspective, this requirement represents one of the main dynamic sizing cases for the aircraft ECS. In particular, it drives the sizing of the air cycle machines (ACMs) or air conditioning packs. These refrigeration units are based on the air cycle cooling process and represent the core of the ECS.

A typical ECS architecture is shown in the schematics below. Compressed hot air is bled from the engine compressors or the APU (not represented here), cooled by a pre-cooler heat exchanger installed downstream the engine bleed ports and conveyed to the ACMs. Each ACM consists of a compressor, a turbine and a fan mounted on the same shaft. Hot air bled from the engine compressors passes through the primary heat exchanger where it is cooled before entering the compressor. Compressed air passes through the main heat exchanger, a re-heater and a condenser before entering the turbine. At the exit, air humidity is removed by another passage through the condenser. At this point, the cooled air is conveyed to the mixing unit.

This architecture is known as 3-wheel machine, and a common variant is the 4-wheel machine where a second turbine is added on the same shaft downstream the condenser.

From the mixing unit, the fresh air is then distributed to the cabin, here divided into three main zones, namely the flight deck, the forward and the aft cabin.

It is clear that in order to speed up the design of the ACMs and hence reduce development time and costs, it is necessary to assess their performance integrating them into the ECS with the appropriate environmental conditions. Simcenter Amesim software provides powerful capabilities which help you model and integrate multi-physical systems as well as evaluate their performance for different sizing scenarios.

Optimizing ECS design with Simcenter Amesim

Contributing to international research projects and working closely with our customers, Siemens PLM Software developed a methodology that, starting from the aforementioned requirements, allows engineers to derive the required power to be delivered by the ACMs to cool down or heat up the cabin, to model the equipment and to integrate it with the ECS model. This methodology, summarized in the following sections, is explained in more detail in the standard demonstrators included in Simcenter Amesim and applied to industrial use cases as described in papers [1] and [2].

Assessing power requirements

The first step of the methodology consists of discretizing the aircraft structure by applying a nodal approach with a goal of capturing its thermal behavior. This can be achieved using

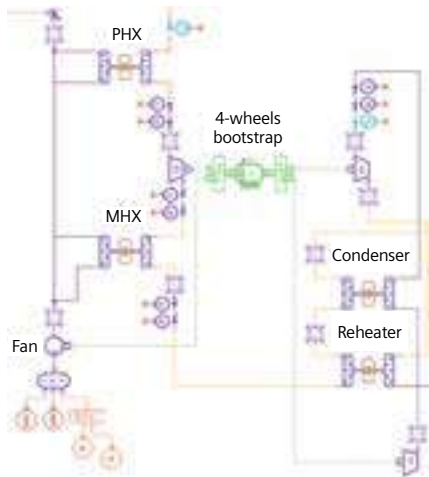
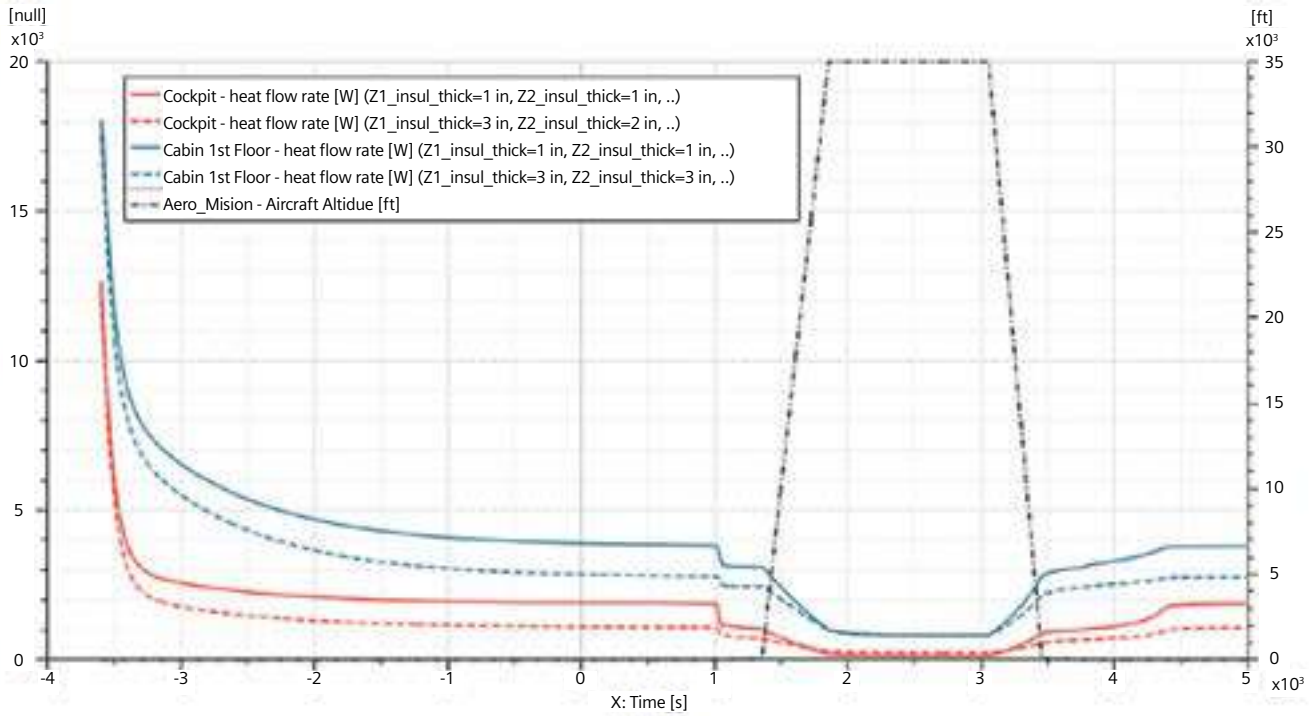

the Simcenter Amesim thermal library. The equivalent thermal circuit of a section of a double deck fuselage aircraft is illustrated in the picture below on the left. On the right, the corresponding Simcenter Amesim model is depicted.

This nodal approach can be applied to the entire fuselage discretizing it along the longitudinal axis.

Using this approach, the desired cabin temperature is imposed, while the atmospheric boundary conditions, computed with the dedicated components of the Simcenter Amesim Aeronautics and Space library, vary according to the specified mission profile. As a result, you can compute the heat flow rates in the cabin during the flight mission. These are plotted below for different thicknesses of the insulation layer. The heat flow rates represent the required power that the ECS must deliver to maintain the desired cabin temperature throughout the flight.

Modeling air cycle machines

Once the preliminary power requirements for the ACM are available, these can be modeled using the Simcenter Amesim Gas Mixture and Moist Air library. This is the second step of the methodology. An example

of a 4-wheel ACM is depicted in the figure above.

With this kind of model it is possible to study the gas temperature and pressure evolution in the ACM components and size them effectively. Furthermore, the start-up procedure was simulated as follows. The aircraft is at rest on the ground. At $t = 2s$, the flow control valve connecting the left engine bleed system to the ACM is opened, letting hot pressurized air flow through it. The right flow control valve is opened at $t = 3s$. The mixing point target temperature is set at 293 K, and then lowered at 288 K and 283 K at 12 and at 15 s respectively.

The results are plotted below. In the first subplot one can notice that as the flow control valve is opened, the pressure builds up accelerating the turbine. In the second subplot, the target and computed temperature of the mixing point are plotted, together with the trim air valve opening fraction.

Analyzing results

From a performance modeling perspective, the rest of the ECS mainly consists of pipes and other equipment dedicated to the distribution of the pressurized air from the engine bleed ports to the cabin. This portion of the

system can be easily modeled with the Gas Mixture and Moist Air library.

Finally, the models of the aircraft thermal structure and the ACMs and distribution network can be integrated together. This allows you, among other things, to verify that the cooling units are correctly sized and to simulate the overall system performance during failure conditions.

The initial objective of this article was to simulate the “pull-down” or cabin cooling case scenario. This is possible with the integrated model and the results achieved are plotted below. The first subplot shows the aircraft mission profile, i.e. the Mach number and the altitude from which the static and total pressure and temperatures are derived. The second subplot shows instead the atmospheric static temperature and the temperature inside the cabin. You can note that the initial cabin temperature is set to 45°C (113°F) and the atmospheric static temperature on ground is 40°C (104°F). The plot cursor is set at t=0s, i.e. 30 minutes after the ACM start-up.

Therefore, using Simcenter Amesim you can see how the cabin temperature falls below the requested threshold, and validate the system performance for the “pull-down” or cabin cooling case.

Related content

- [1] Cappuzzo, F., Broca, O., and Leboi, J., "Simulation of Aircraft Virtual Architecture - Bleed Off-Take and ECS," SAE Technical Paper 2017-01-2159, 2017, <https://doi.org/10.4271/2017-01-2159>.
- [2] Unlu, D., Cappuzzo, F., Broca, O., and Borrelli, P., "Minimizing Aircraft ECS Bleed Off-Take - Virtual Integrated Aircraft Applications," SAE Int. J. Aerosp. 9(1):151-162, 2016, <https://doi.org/10.4271/2016-01-2054>. ■

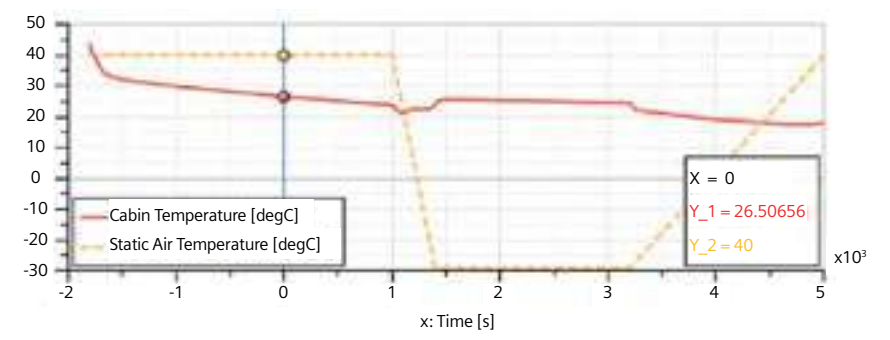
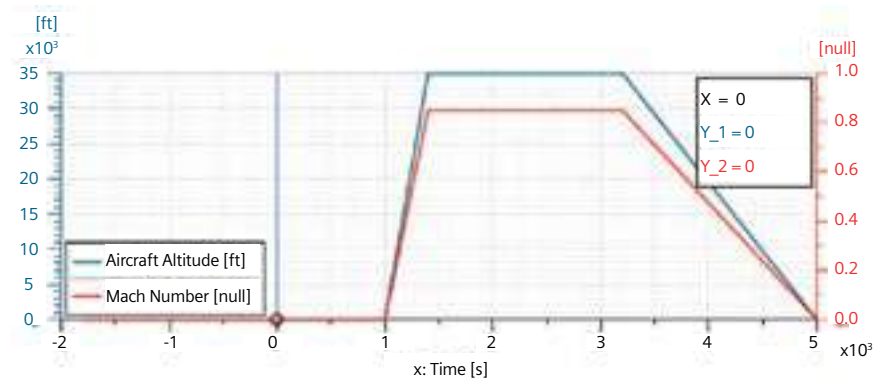
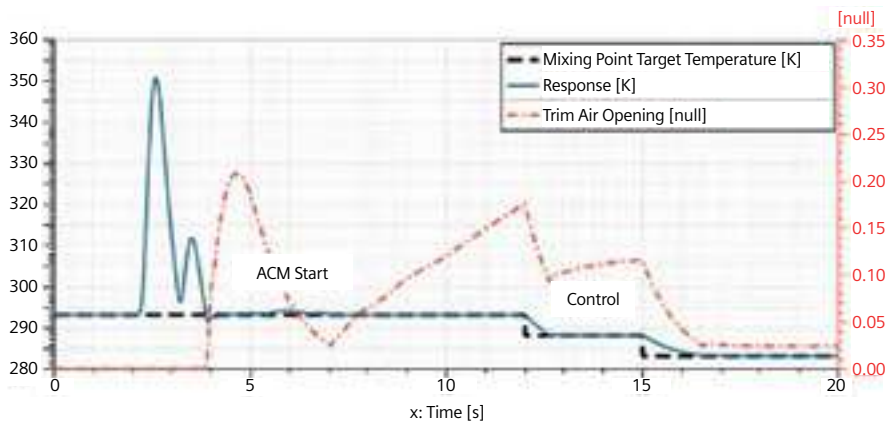
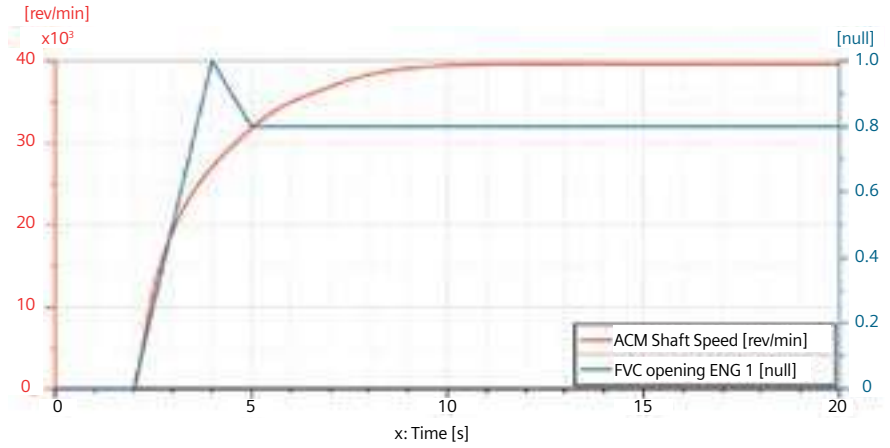



Hyundai Motor Company

Global auto manufacturer uses Simcenter to optimize hybrid vehicle performance



Korean modernity

Over the last two centuries, mankind has dramatically evolved. And certainly, modern times have brought many benefits, including longer lives, comfort, communication means, traveling tools and much more. But at the same time, continuous population growth, industrialization and globalization have put enormous stress on the environment. Unfortunately, it was only in the last decades of the previous century that scientists started to share persuasive evidence that we are slowly but certainly causing irreparable damage to our planet.

The current generation is the first in human history to consider how to balance technological advancement with low environmental impact. As a result, engineers are challenged to develop technologies that can satisfy operational and consumer requirements while also meeting the demands for low energy consumption and emissions. To fulfill those demands, many industries, particularly transportation, will require a drastic modernization, both technologically and in terms of process.

It's not a coincidence that the Korean word for modernity is "hyundai." The engineers of Hyundai Motor Group (HGC), the third-largest vehicle manufacturer in the world, have experimented since the late 1980s with alternative, more environmentally-friendly propulsion methods than traditional internal combustion engines (ICEs), including flexible-fuel vehicles, electric vehicles and hybrid-electric vehicles (HEVs). The latter are currently the most interesting, awaiting the availability of batteries that can allow a larger range and additional infrastructure to charge electric motors.

Complex HEV engineering

Designing HEVs presents complex challenges, such as determining which configuration will perform the best for a particular vehicle and its intended use. The main idea is to let the electrical motor support the ICE so that it can work more efficiently, or even be replaced for some drive cycles, like city use, for example. Significant engineering effort goes into the sizing of components and in defining the control algorithms that coordinates the

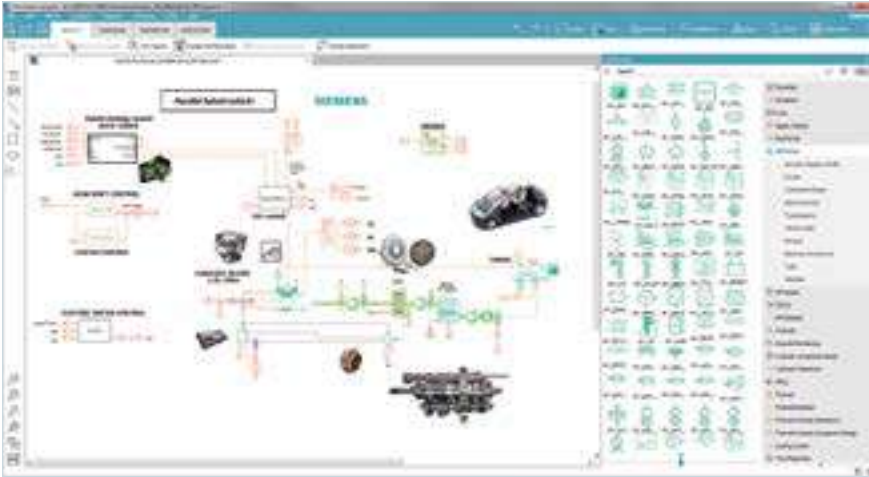

collaboration of the electric motor and ICE for optimal efficiency. At the same time, engineers must consider other critical performance requirements, including driving dynamics and comfort.

“As the effect of changing a parameter in favor of one performance aspect can negatively influence another, we have to look at multiple attributes simultaneously to find the optimal balance,” says Bang Jae-Sung, senior engineer at Hyundai. Jae-Sung is one of the specialists at Hyundai’s R&D center who focuses on developing the HEV control logic for optimal vehicle performance. “On top of that, with so many parameters involved and so many different drive cycles to evaluate, it would become a very time-consuming and costly affair if too much of the process still relied on trial and error.”

Implementing a simulation-based approach

Together with Siemens PLM Software specialists, Hyundai engineers researched the possibility of saving development time and cost by implementing a more automated performance optimization process, using state-of-the-art simulation capabilities. Together, they executed a project in which they virtually tested, validated and calibrated an HEV main controller using a real-time, closed-loop, model-based system simulation. Though hardware in-the-loop (HiL) test platforms are industry-standard, this test case was rather unique in that it accurately captured both fuel economy and drivability simultaneously.

“HiL simulation can be a difficult balancing task,” says Jae-Sung. “On one hand, you have to limit the number of

“The project we did with the Simcenter Engineering specialists showed us that we can realize a good correlation between results from HiL simulation and the real vehicle behavior for multiple attributes simultaneously.”

Bang Jae-Sung, Ph.D.
Senior engineer R&D Center
Hyundai Motor Company



“By pre-defining major calibration values using HiL simulation, we were able to reduce the number of actual vehicle tests by 40 percent.”

Bang Jae-Sung, Ph.D.
Senior engineer R&D Center
Hyundai Motor Company

degrees of freedom (DOFs) so that the calculation can run in real-time, but on the other hand the simulation model needs to remain sufficiently accurate so that it still produces realistic results. This requires very specialized software tools. By using Simcenter Amesim software from Siemens PLM Software for the plant model in co-simulation with the MATLAB, Simulink and Stateflow environments for the controller models, we could achieve this objective really well.”

Besides the supervisory hybrid control unit (HCU), which was the main subject of the validation study, the engineers also had to model the subsystem controllers to an appropriate level of detail. The engine management system (EMS) for example, regulates fuel, air and spark to produce the torque that is commanded from the HCU. If this feature is not modeled accurately, it can lead to significant deviations when predicting fuel economy and the battery’s state of charge. Other subsystems add to the complexity.

The dynamic Simcenter Amesim model included the required physics to accurately capture the energy flows and conversions from fuel to mechanical and electrical energy. For drivability assessment, the model possessed all the relevant elements for replicating the natural frequencies between 0 and 20 Hertz (Hz), as these can be felt by the driver. The model also included the

efficiencies and energy losses of the main components necessary to predict fuel economy. The model was systematically built from component to full vehicle, validated in each of these stages, and later simplified to run in real time.

Reducing physical testing

“The project we did with the Simcenter Engineering specialists showed us that we can realize a good correlation between results from HiL simulation and the real vehicle behavior for multiple attributes simultaneously,” says Jae-Sung. “It confirmed that we can use this approach for upfront performance validation, as it allows us to quickly evaluate trends when designing HCU algorithms and defining calibration values, so that we can achieve a better starting point for physical prototyping.”

The implementation of the Simcenter Amesim based process as a standard development practice allows Hyundai engineers to improve the performance of HEVs while dramatically reducing time and cost. “By pre-defining major calibration values using HiL simulation, we were able to reduce the number of actual vehicle tests by 40 percent,” confirms Jae-Sung. “And we are in the process of extending the scope of this methodology to a much larger number of test scenarios, by including additional physics in the models, such as thermal effects on engine, electric



motor and battery, road geometry, vehicle lateral dynamics and many more.”

Future ambitions

This thorough digitalization of the process for eco-friendly vehicle design aligns with Hyundai’s long-term vision. In its mission statement, Hyundai clearly expresses the ambition of fulfilling its role and responsibility as a trusted global firm, while at the same time continuously improving the customer experience. To achieve this dual goal, the company counts on effectively delivering innovative mobility solutions based on technologies that are both eco-friendly and human-oriented. Adding value to their vehicles by applying this digital transformation to product development is a logical part of this endeavor.

The next step is just around the corner. Rising innovations such as cloud computing, big data analytics and the Internet of Things offer new technological perspectives. They will also enable companies like Hyundai to stay closely connected to their

customers and, for example, get more information on the actual use of their vehicles, even on an individual basis.

“Making a vehicle smart by digitally connecting development and operation will be the next technological revolution,” confirms Jae-Sung. “For our application, we could imagine that additional improvement of performance and energy efficiency can be achieved by developing a control logic that can reflect the driver’s tendencies, and gather on-the-spot information on the actual traffic density. In that sense, digitalizing vehicle development is just one step in a broader process.”

It is a vision that matches current industry trends, and one that Siemens PLM Software endorses. To realize this vision, Siemens is gathering all the building blocks for an environment that facilitates a digital thread throughout the entire product lifecycle. Through ambitious development plans and acquisitions, Siemens clearly aspires to support their customers when they create the next modernity – in Korean: the next Hyundai. ■

“Making a vehicle smart by digitally connecting development and operation will be the next technological revolution.”

Bang Jae-Sung, Ph.D.
Senior engineer R&D Center
Hyundai Motor Company



Sound Camera

Home appliances: from noise troubleshooting to noise reduction strategies

The current trends of living in increasingly dense cities, buying smaller living areas, and having open kitchens means that people are constantly surrounded by noise. Busy environments make having a quieter home something to strive for. Customers have become more sensitive to noise generated by their household appliances. They do not wish their conversations to be disturbed by a dishwasher's cacophony.

Noise levels and sound quality, then, are important characteristics in all kinds of home appliances and white goods, and manufacturers are now acknowledging this trend. They realize that they can use pleasant sounds as brand identity and as a competitive advantage. These manufacturers optimize noise levels and the quality of the sound produced in each of their products in order to bring acoustically better goods to the market.

For this, however, manufacturers must follow certain regulations and standards set by the International Organization for Standardization (ISO). For example, the ISO-based sound power procedure allows the comparison of noise values between different equipment in an absolute way, independent from the distance to the object and from the acoustical environment where it was measured. Moreover, the value obtained from the ISO sound power test appears on the European Energy Label for white goods. It allows manufacturers to compare their equipment with previous generations or with competitor brands. It also guarantees the end-user that they are choosing the quietest brand when purchasing an appliance at the store or online.

However, measuring the sound power value is one thing. What if your main competitor releases a new model that is

only 1 or 2 decibels (dB) lower than yours? Such developments in the market may make you lose the market share and may cause a significant loss of money.

How can you make sure that you will be able to decrease the sound power value of your next generation dishwasher or washing machine? Certainly not by a trial-and-error approach, nor by randomly adding acoustical material to the prototype. These approaches are far from optimal and they do not guarantee success. Luckily, different test-based approaches can help you lower the sound power value in a systematic and time efficient way.

Smart strategies to improve noise in products

As a strategy, you can 'block' the noise, try to 'find' where it comes from, and with some further details, you can 'understand' the underlying phenomena.

Block the noise

You can block the noise quite easily by adding acoustic material to dampen or absorb the noise before it enters the room. Extra acoustic material can be used inside the equipment to help lower the emitted noise. Typically, a bitumen layer is put on the side panels of, for instance, washing machines and dishwashers.

But what if you want to try new materials or a combination of multiple layers? It is not necessary to apply all the different acoustic materials every time you want to test it. Quantifying the acoustical absorption and transmission loss characteristics of such materials can be done on a small sample using impedance tube standards, such as ISO10534 or ASTM E1050, using the Simcenter Testlab Sound Absorption or Sound Transmission Loss solutions. As an



Figure 1: European Energy Label

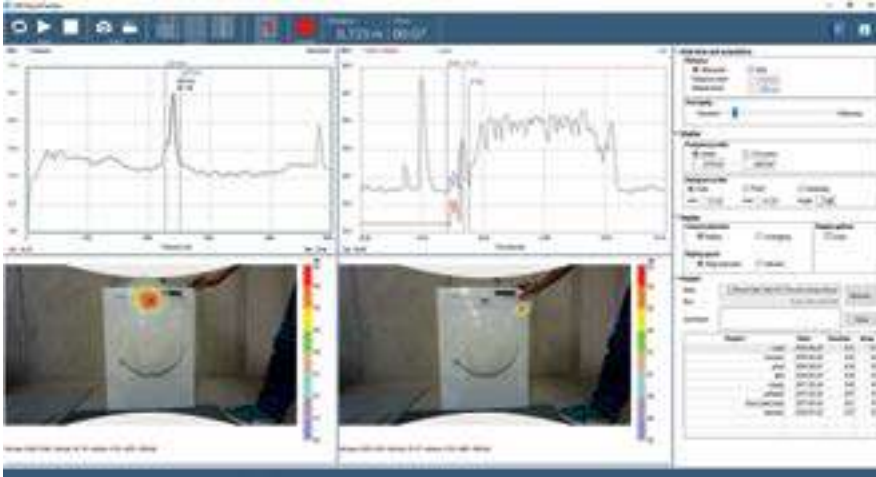

Figure 2: Sound Camera

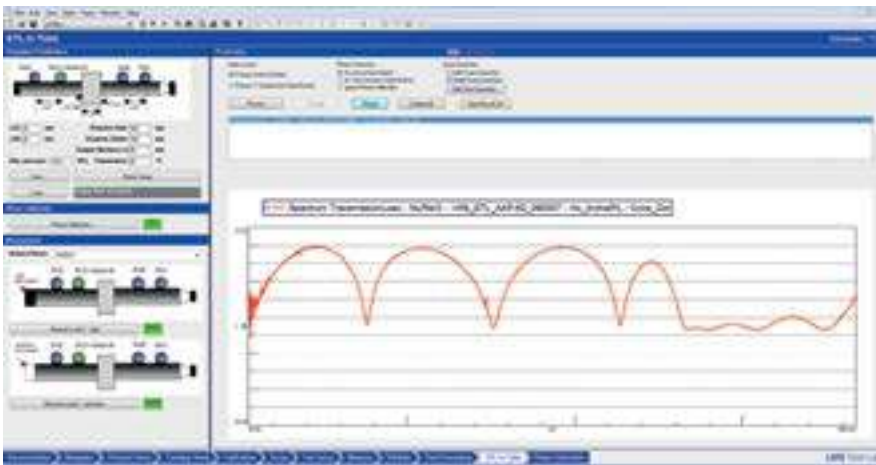

Figure 3: Transmission loss measurement

alternative, room-based testing setups (ISO354 and ISO140) provide the same absorption and transmission loss curves.

Once you select the optimal material, knowing where to apply it is next. It is not efficient to place the acoustical material on all panels. A better approach is to find the locations where such a material is most effective. If you produce

thousands of dishwashers a day, saving one cent per unit on acoustical material could mean huge savings in cost. Knowing where the main noise leaks are located will tell you where you need to modify the design. The fastest way to find noise leaks is by using an array-based sound source localization technique, such as the one offered by the Simcenter™ Sound Camera™ System.

Real-time holograms show the acoustical hotspots, as well as the critical frequencies. Very similar to an infrared camera (where designated colors indicate the zones with higher temperatures), the sound camera shows you where the highest noise levels are originating from.

Understand the noise path

Instead of looking where the noise leaks out, another strategy can be to tackle the problem from inside. A washing machine has a lot of moving parts: rotating motors and belts, springs that hold the tumble, etc. They either generate vibrations and induce noise (the sources) or amplify certain frequencies (the transfer paths), such that an unexpected noise problem might occur (the receiver end). Our source transfer receiver approach will help you understand the underlying dynamic phenomena.

All components are identified and characterized as a function of their dynamic behavior. Understanding their interaction and knowing the critical frequencies and paths will help determine the “guilty component” you should be working on. This systematic approach can be started in a very simple manner by using impact testing and looking at transfer functions. Much more detailed insights on the complete dynamic behavior of your products can be obtained with Simcenter Testlab Transfer Path Analysis (TPA).

Shape the noise

Some manufacturers of home appliances go even one step further: once they have the noise levels well under control, they start to examine how their equipment sounds and whether this sound is appreciated by the end-user. The beeping sound when pushing the start button, the opening and closing of the door, and the splashing sound when the washing machine does the laundry is all

orchestrated into one pleasing hearing experience. Shaping the generated sound so the human ear likes it is the domain of sound quality engineering; a domain rather new to the home appliances industry, but a well-established one in the automotive industry for decades.

The process of sound quality engineering involves the recording of different sounds, which is done using a binaural recording device, such as Simcenter SCADAS XS and the binaural headset. These recordings can either be used to calculate sound quality metrics using Simcenter Testlab Neo Sound Quality Analysis or to run some listening sessions with a sample group of customers (called 'jury testing') using Simcenter Testlab Jury Testing.

Sound quality metrics are objective calculations that intent to express how

well certain sounds are appreciated by human being. Jury testing does the same in a subjective way by replaying the recorded sounds to a group of people who then electronically report their assessment of the sounds. However, as jury testing sessions are very time consuming, the goal is to find a "golden formula" that combines sound metrics that correlate with the results obtained from jury testing campaigns.

All in all, combining different testing techniques will guarantee that the noise levels and sound quality of your home appliances stay under control. For all aspects concerning sound quality testing—binaural recording, sound metrics and jury testing—the Simcenter Testlab software and the Simcenter SCADAS platform offer dedicated tools and specific user-interfaces that help complete these tasks efficiently. ■



Figure 4: Simcenter SCADAS XS



Figure 5: Simcenter Testlab Neo



Figure 6: Jury Testing using binaural headsets

Volvo Trucks

Truck manufacturer uses Simcenter Testlab and Simcenter SCADAS to improve cabin sound quality



Make truck driving safe and enjoyable

"I love truck driving," says Theresia Manns. "The ride behavior of a heavyweight can't be compared to a car. You feel much more involved when driving a truck. There is no room for boredom as you have to constantly assess driving conditions and be in control." Manns is not a professional truck driver, journeying millions of miles across Europe to bring resources and manufactured goods to their final destination. Instead, she helps develop next-generation trucks for the Volvo Trucks company in her hometown of Gothenburg, Sweden.

Her mission is to turn truck driving into an enjoyable, comfortable experience for drivers and passengers. As a noise, vibration and harshness (NVH) engineer, she understands the impact of ride comfort on attributes such as quality perception, driving pleasure and safety.

"My focus is to improve the sound quality in the truck's cabin," says Manns, a senior feature analyst in the noise and vibration laboratory, part of the Volvo Trucks Technology Group. "Sound quality is definitely not a negligible aspect of truck design and development. Poor sound quality and the occurrence of disturbing noises cause additional stress and mental fatigue for the driver."

Scout for clues

Manns compares her job to that of a detective. Whenever a noise issue occurs, she investigates the origin of the problem and proposes appropriate countermeasures. "It is a very challenging role," she comments. "We

have to be accurate in our analyses in order to find the exact cause of the annoyance, reveal the nature of the problem and propose an adequate solution to it."

The Simcenter Testlab 3D Acoustic Camera software, with its Simcenter™ Solid Sphere Array hardware, is one of Volvo Trucks' preferred tools for acoustic measurements.

The spherical acoustic camera can be used to scan the inside of a truck's cabin (Figure 1), measuring the sound field while omitting reverbs, and overlaying the depiction of the real sound sources to the 3D geometry of the truck's interior. In other words, it displays acoustic hot spots on a photograph of

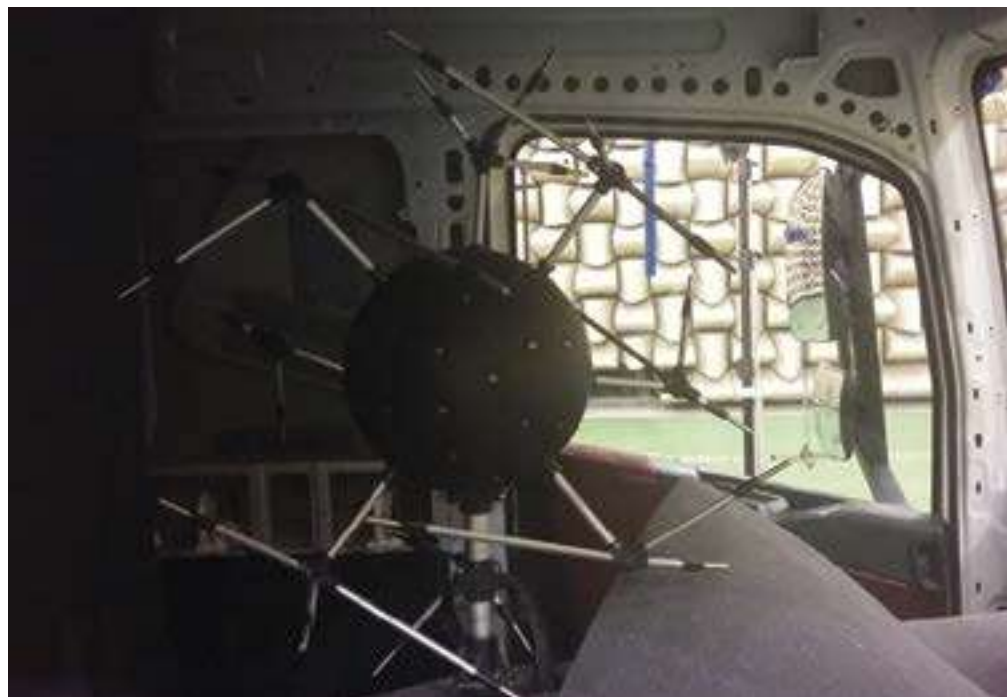

Figure 1: Spherical acoustic camera used to scan the inside of a truck's cabin



those are rare, valuable items. The array is often employed when the team tests or benchmarks vehicles at its Swedish proving ground track Hällered. “When necessary, the tool allows us to perform multiple tests during the same measurement run as long as the other test is not influencing the acoustics,” says Manns. “We don’t always need to dedicate the test to acoustic quality only.”

Although not easily quantified, the time gained by being able to perform multiple simultaneous tests is important.

the interior. In the past, Manns had to check many points to find the origin of a troubling noise, but now she can see it on the image. This method provides quick input for further investigations; the acousticians can estimate and rank potential noise issues based on the picture. As a result, the engineering team at Volvo Trucks can make relevant modifications and focus on the next action.

Time-saving testing methods

This drastically simplifies truck instrumentation and shortens instrumentation time. “It is difficult to estimate the time gain, but I know it to be consequential,” says Manns. “Before we would perform larger sound analysis on various occasions, doing one test at a time. Now we check many potential weak spots in a single measurement run. Setting up the Simcenter Testlab 3D Acoustic Camera takes us less than two hours, and the measurement is really quick. The array makes it a lot easier to assess multiple vehicles in shorter times, for benchmark, quality checks or hot spot detection on a prototype.”

Time efficiency in measurement is a true asset when testing prototypes as

The setup of the acoustic camera is relatively straightforward after a short induction, and it can be used in numerous circumstances. In the test cell, the acoustic camera is employed for the full system as well as component testing. The array is useful on the test track and in test cells, but it also serves the purpose of aero-acoustic measurements in the wind tunnel.

“The fact that we can use the array while performing other tests is a huge money saver,” says Manns. “For example, we can instrument a truck in order to get our data while it is undergoing an aerodynamic test in the wind tunnel to see both aerodynamic and aeroacoustics impact simultaneously.”

Knowing that wind tunnel tests are extremely costly, every gigabyte of collected data should be worth its money. While the installed camera records huge data sets on the connected Simcenter SCADAS Mobile hardware, the system’s powerful Simcenter Testlab software facilitates value-added postprocessing, rapidly delivering results and information.

“Setting up the Simcenter Testlab 3D Acoustic Camera takes us less than two hours, and the measurement is really quick.”

Theresia Manns
Senior feature analyst
Volvo Trucks

The convincing power of images

The acoustic camera system offers more than data capture. The obtained image overlay provides unmistakable evidence of the analysis results. Multiple data sets can easily be compared at a glance as the powerful analysis software features multi-batch processing capabilities. In that way, different configurations are quickly compared and assessed, saving precious analysis time on individual data sets.

In the lower frequencies, acoustic pressure is often the cause of faintly perceived annoyances that prove to be tiresome for long-haul truck drivers. Using the Simcenter Testlab 3D Acoustic Camera, the NVH team at Volvo Trucks applies the equivalent source method (ESM) to obtain clear displays of the low- to mid-frequency noise sources. ESM also helps quantify noise sources so that they can be ranked in order of sound contribution.

Manns notes the system lets experts point to a selected sound source, displayed as a red spot on the computer screen and replay the audio file of the identified noise issue. Further, she explains it allows them to analyze, rank and compare the sound contribution of various large areas such as the vehicle's dashboard, side windows, roof air vents, etc.

Beyond the strong analysis capabilities of the system's software, Manns says, "The Simcenter solution is a user-friendly tool for presenting results to designers and the management team." To adapt a well-known phrase, since an image is worth a thousand words, the graphical results obtained with the array demonstrate the value of design modification.

Putting the test system through its paces

Manns is an enthusiastic user of the Simcenter Testlab 3D Acoustic Camera system, but admits that she and her team have not been blindly trusting the tool from the start: "We performed numerous tests with the Simcenter Testlab 3D Acoustic Camera before deciding to invest in it. Ultimately, the method convinced us, and today the array constitutes a valuable asset for our testing team."

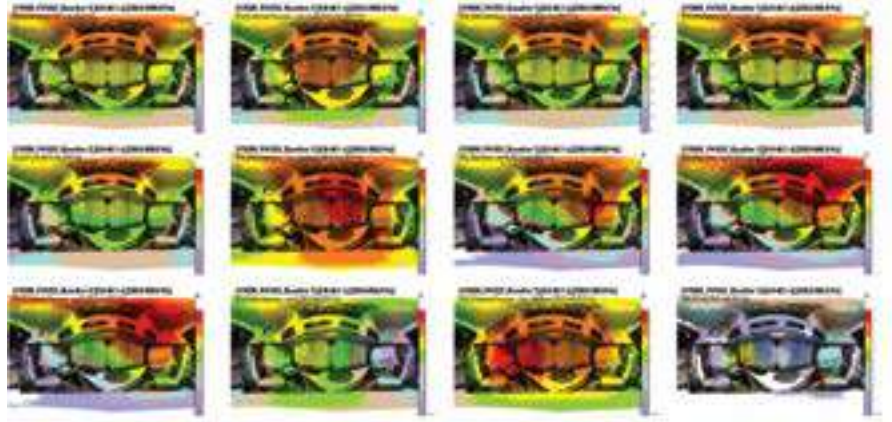

“The array makes it a lot easier to assess multiple vehicles in shorter times, for benchmark, quality checks or hot spot detection on a prototype.”

Theresia Manns
Senior feature analyst
Volvo Trucks

With the first electric trucks rolling out the Volvo Trucks production lines by 2019, it is expected that Manns and the other engineers in the team will take up an increased workload. As Claes Nilsson, president of Volvo Trucks, states in a press release: "This opens the door to new forms of cooperation with cities that target to improve air quality, reduce traffic noise, and cut congestion during peak hours since commercial operations can instead be carried out quietly and without tailpipe exhaust emissions early in the morning or late at night."

Achieving quiet operation has always been the challenge of the team of acousticians. In acoustic terms, truck electrification translates in different, often more tonal sound issues. There is no doubt the Simcenter Testlab 3D Acoustic Camera is a strong asset for helping to detect and eradicate those issues. ■

Figure 1: Model of an egg frying on a CPU in Simcenter FloTHERM XT

Geek Hub

This time...Frying an Egg on a CPU!

By James Forsyth, Engineering intern, Mentor, a Siemens Business

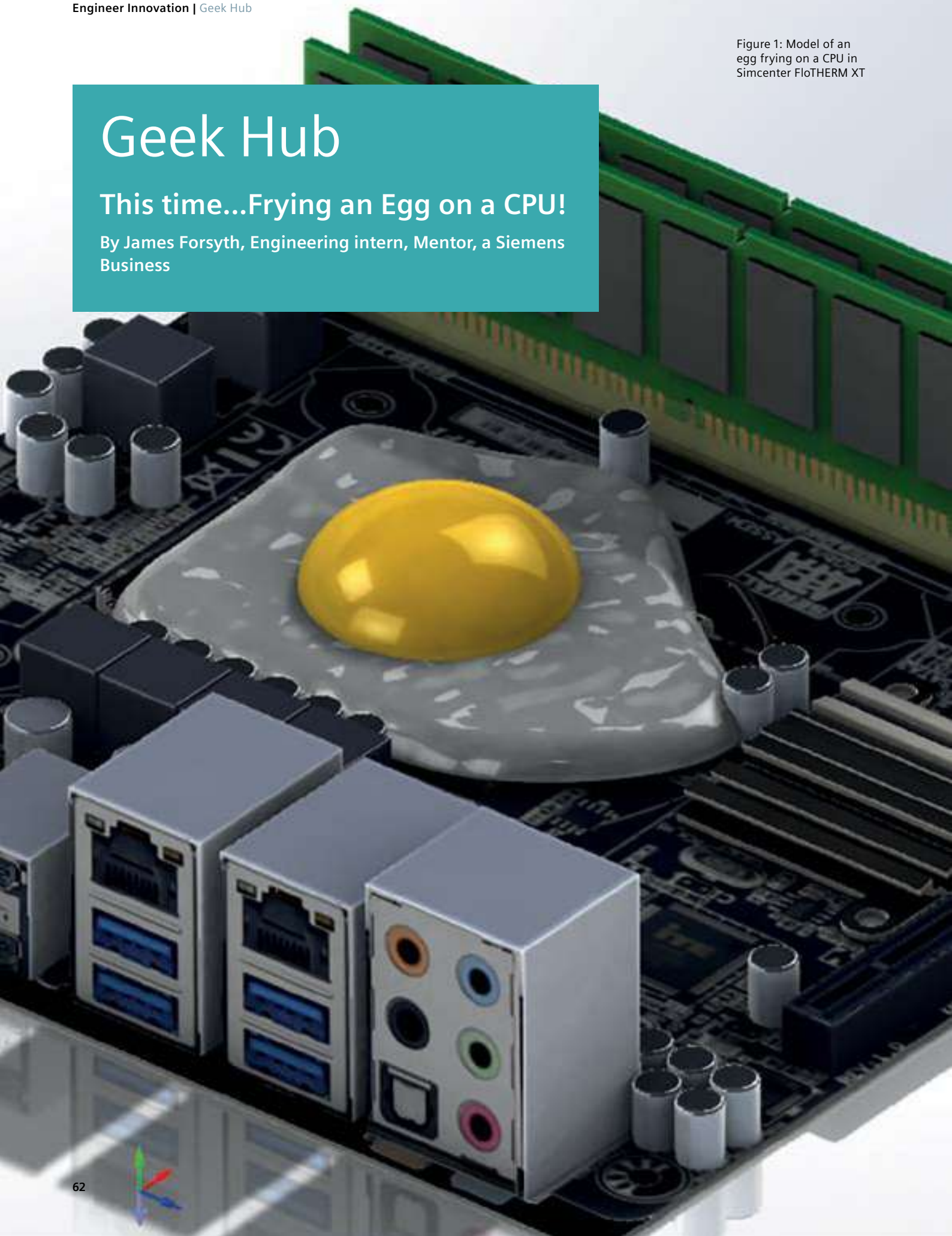

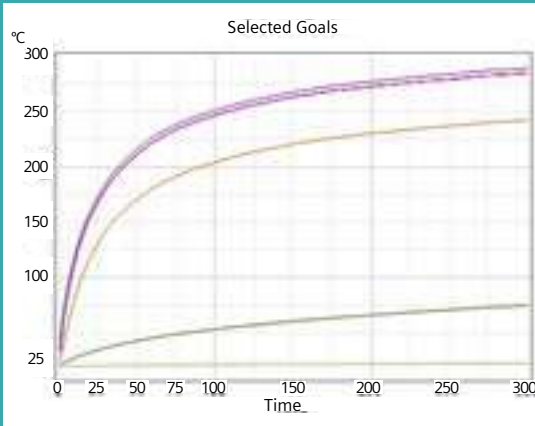

Figure 2: Temperature against time for egg cooled CPU

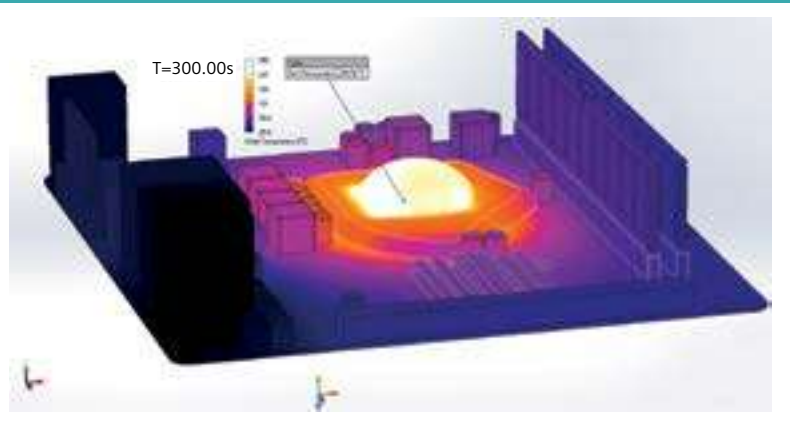

Figure 3: Temperature surface plot of egg after five minutes of heating

Solving complex thermal models with CFD requires a lot of processing power and a CPU under full load generates a fair amount of heat. But can you cook an egg on it? Search online and you can find videos of people attempting to cook on their processors, but how effective as a cooling solution is this? Before you throw away your conventional heatsink and fan, in favor of a multifunctional omelette, we'll investigate what CFD in Simcenter™ Flotherm™ XT software can predict about the fate of your PC if you do so.

Model

As a student intern at Mentor, a Siemens Business I get the opportunity to create and play with interesting and unusual thermal models made in the software. For this concept, I started by creating a very basic project comprising two cuboids and a cylinder to model a motherboard, processor and egg. Then I did some research – standard dimensions for motherboards, CPU thermal design power (TDP), thermal data for eggs.

Using this very simple model, I was able to test things rapidly, get a rough feel for the range of temperatures and evaluate how feasible the concept was to model.

I then created a more detailed model, starting by importing a board using FLOEDA Bridge, a tool in Simcenter Flotherm XT that allows 3D CAD geometry to be produced from an intuitive 2D EDA environment. Using a topographical image of a representative mITX motherboard and a selection of known dimensions, I was able to accurately scale the image as a

texture onto the board. This allowed the footprints of the board components to be positioned accurately against the image.

An excessively detailed board is not necessary for this model as we are only interested in the CPU temperature. To do this, the model needs to include the major sources of heat and any geometry that may alter the flow of air around critical components. The geometry around the CPU, such as the CPU socket, needs to be much more detailed as this has a significant effect on heat transfer by conduction. The CPU itself is modeled with accurate geometry and a two-resistor network assembly thermal model, based on an Intel® Core™ i3-4130 as a representative mid-range desktop processor. Typical maximum T_{junc} and T_{case} are 90°C and 72°C.[1] The geometry far from the CPU, such as the I/O ports, can be modeled as simple cuboids that will present an obstacle to air flow on that edge of the board. Additional detail would just prolong the solver computation time with diminutive improvement in accuracy.

Limitations

One consideration is that the egg cannot quite be simplified to a material with thermal properties dependent on temperature, which Simcenter Flotherm XT is easily capable of modeling. For instance, apply heat to a block of aluminum and that energy will all eventually be transferred to the ambient air



as it cools. Do the same to an egg and not all of the energy will be transferred to the ambient; cooking an egg is an endothermic process and a proportion of the energy will be converted to the change in chemical enthalpy of the egg as it cooks.[2]

So the question is: how significant is this lost 'cooking energy' to our model? Well, after some research and calculations, not very. The specific enthalpy to denature the egg proteins during cooking is around 2.7 J/g for egg white and around 1.0 J/g egg yolk,[3,4] so for an average 50 g egg, the total energy required is only around 80J. This energy would contribute to a total drop in CPU temperature of approximately 6°C, but this removal of heat can only happen once per egg. Compare this to the 54 W TDP[1] of the CPU under heavy load; after a few minutes of egg cooking, the heat dissipated is of the order of 10 kJ and the protein denaturation can only mitigate a negligible fraction of this.

The majority of the heat supplied ends up, well, heating the egg. The egg's high water content gives it physical properties similar to water – slightly higher densities of 1130 kg/m³ for the yolk and 1133 kg/m³ for the white; specific heat capacities of 3.55-3.60 J/(kg K) for the yolk (increasing with temperature) and 2.55-2.75 J/(kg K) for

the white; thermal conductivities of 0.550-0.558 W/(m K) for the yolk and 0.389-0.407 W/(m K) for the white (decreasing with temperature). The actual values used in the model were based on a moving average of reported experimental data.[5].

Another factor not considered in the model is water in the egg heating up to steam which rises, carrying away heat, though this is in small enough quantities compared to the flow of surrounding air that it can be ignored for now.

These two modeling limitations mean that the results are likely to be a slight overestimation of the temperatures while the egg is still cooking, giving a worst-case scenario. This can often be beneficial; if the worst-case scenario is within thermal design constraints, the actual performance should be superior.

Above 65°C, the white begins to coagulate and above 70°C the yolk solidifies. Once solid and cooked, the egg is a much poorer heatsink; it is less thermally conductive and convection within the egg no longer occurs, it is less dense due to water loss, and air/steam gaps are formed underneath the egg, insulating the CPU causing more heat to accumulate. Modeling the egg as always liquid gives a best-case scenario above 70°C.

Results

Unfortunately, the CPU junction temperature exceeds 90°C within six seconds, at which point the CPU clock would throttle down to reduce the thermal power and prevent damage to the system – less than ideal for a cooling solution. The egg would also burn and catch fire.

The central location of the CPU on the board and the large obstacles to air flow in the neighboring memory DIMMS and I/O ports mean limited cold air can passively flow over the hot egg by natural convection. Even adjusting the results for the modeling limitations described earlier, there is simply insufficient cooling.

For comparison, a new project configuration was created with the egg substituted for a standard Intel® stock

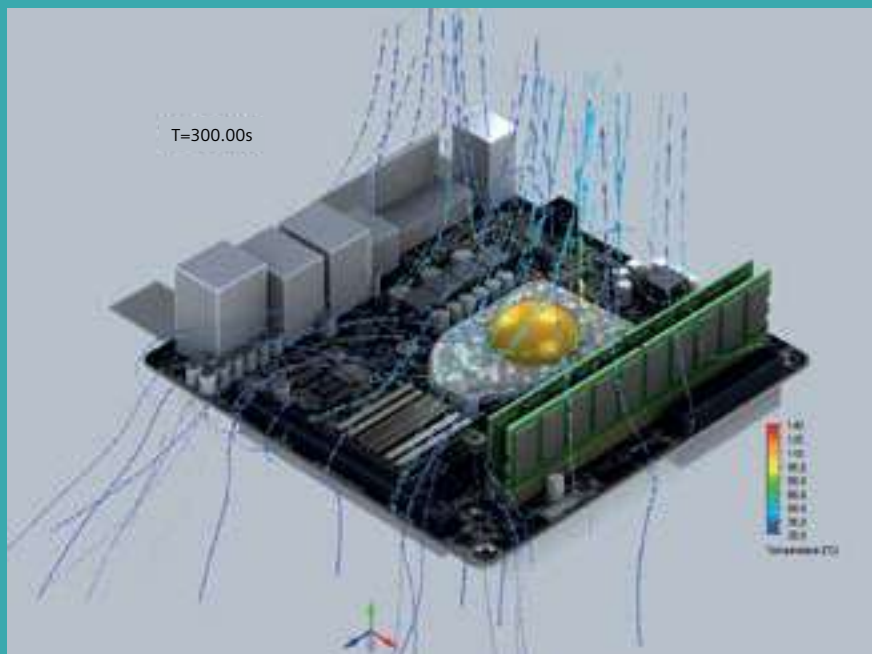

Figure 4: Particle plot, showing air flow around egg and CPU

CPU cooler radial heatsink and fan. Once solved, this gave a junction temperature of 65.1°C after five minutes of the CPU being under full load at 54W with the system approaching equilibrium.

Conclusion

The passive cooling of the egg cannot match the forced convection of the stock cooler. An egg-based cooling solution could only keep the CPU below the maximum 90°C T_{junc} if the CPU performance were throttled down to 10W TDP, so there are only possible applications in lower power environments with plenty of ventilation. With the requirement of frequently swapping out the egg, I can't see this catching on. If the aim is to cook eggs though, CPU's certainly produce enough heat to do so; with thermal throttling, the processor acts as a thermostatically controlled surface at around 90°C, sufficient to cook on. If you value your computer, maybe consider buy a frying pan instead.

References

[1] Intel Corporation, 2014. ARK | Intel® Core™ i3-4130 Processor (3M Cache, 3.40 GHz) [online]. http://ark.intel.com/products/77480/Intel-Core-i3-4130-Processor-3M-Cache-3_40-GHz [accessed April 2015]

[2] J. McClements, University of Massachusetts, 2001. Thermal Analysis of Foods [online]. <http://people.umass.edu/~mcclemen/581Thermal.html> [accessed April 2015]



Figure 5: Board with egg replaced with stock CPU cooler

[3] C. Németh, K. Horváth, Á. Drobecz, L. Friedrich, K. Pásztor-Huszár, C. Balla. Calorimetric study of changes induced by preservatives in liquid egg products. Polish Journal of Food and Nutrition Sciences, 2010, Vol.60(4)

[4] A. Laca, B. Paredes, M. Díaz. Thermal behaviour of lyophilized egg yolk and egg yolk fraction. Journal Of Food Engineering, 2011 Jan, Vol.102(1)

[5] J. Coimbra, A. Gabas, L. Minim, E. Garcia-Rojas, V. Telis, J. Telis-Romero. Density, heat capacity and thermal conductivity of liquid egg products. Journal of Food Engineering, 2006, Vol.74(2) ■

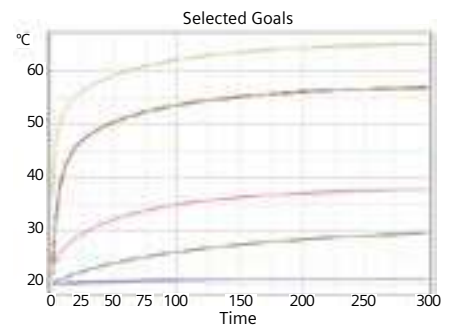

Figure 7: Temperature against time for stock cooled CPU

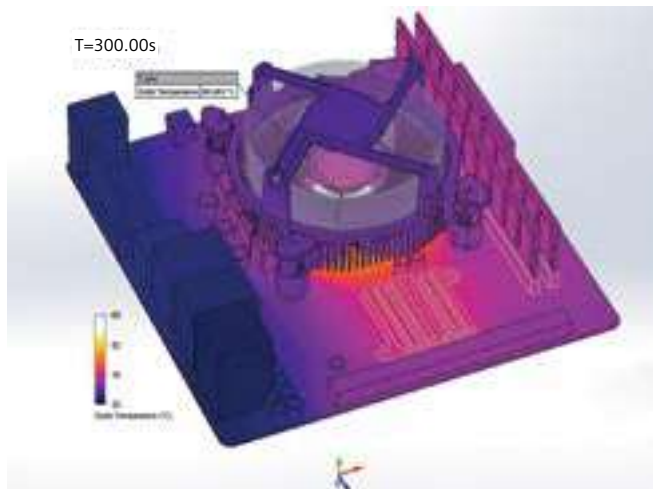

Figure 7: Particle plot showing air flow through stock cooler

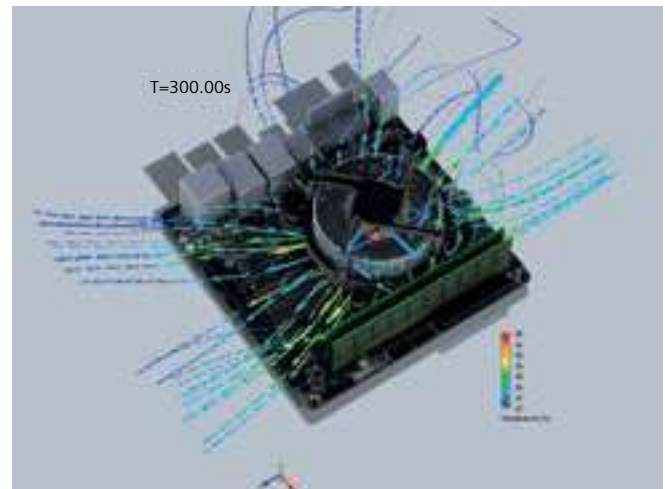

Figure 8: Surface plot of stock cooled CPU

Brownian Motion...

The random musings of a Fluid Dynamicist

How entropy made my house untidy

I am writing this column in a messy room, in a messy house. A house that only hours previously had been (at least to my rather uncritical eye) in a state of almost perfect tidiness, is now in a state of utter disarray.

But of course, none of this is my fault. The blame rests squarely with entropy which, as you might vaguely remember from undergraduate thermodynamics, is a measure of disorder in a system (in this case the untidiness of my house). One of the fundamental principles of physics is that the entropy of a closed system always increases over time.

While there are an almost infinite number of ways that I could arrange the contents of my house, only a very small number of these billions upon billions of permutations would leave the house in a "tidy" state. And certainly, none of those involve socks in the kitchen, discarded underwear in the bathroom or cereal bowls in the bedroom. Since there are always many more disorderly variations than orderly one, almost any interaction I have with my home environment will push it towards a state of "disorder", and only carefully considered deliberate actions will act against the relentless march of entropy and reduce the amount of disorder in my house.

It's a bit like a Rubik's cube. There are 43,252,003,274,489,856,000 different permutations of a Rubik's cube, but only one "correctly solved" state. Anyone can reduce a solved cube to one of those 43 quintillion unsolved permutations with just a few random twists. But no amount of random twisting will ever return the cube to its solved state. Instead, you have to spend effort and energy first learning how to solve the cube and then correctly applying the algorithms to solve it. Or you could just pull the stickers off and stick them back on like everyone else.

Unfortunately for me, the human mind is wired to appreciate order over disorder. Only an artist can turn a selection of paints and a canvas into a beautiful painting. Only a musician can arrange an array of notes into a beautiful song. And only a talented writer can waste time arranging words and letters into an article about entropy when he should be frantically tidying his house.

I fear that none of this will be much consolation to my long-suffering "other half" when she returns home to find her previously tidy house in a state of utter disarray. While I could use the Second Law of Thermodynamics as an excuse, experience tells me that it would probably be safer just to blame it on the dog. ■

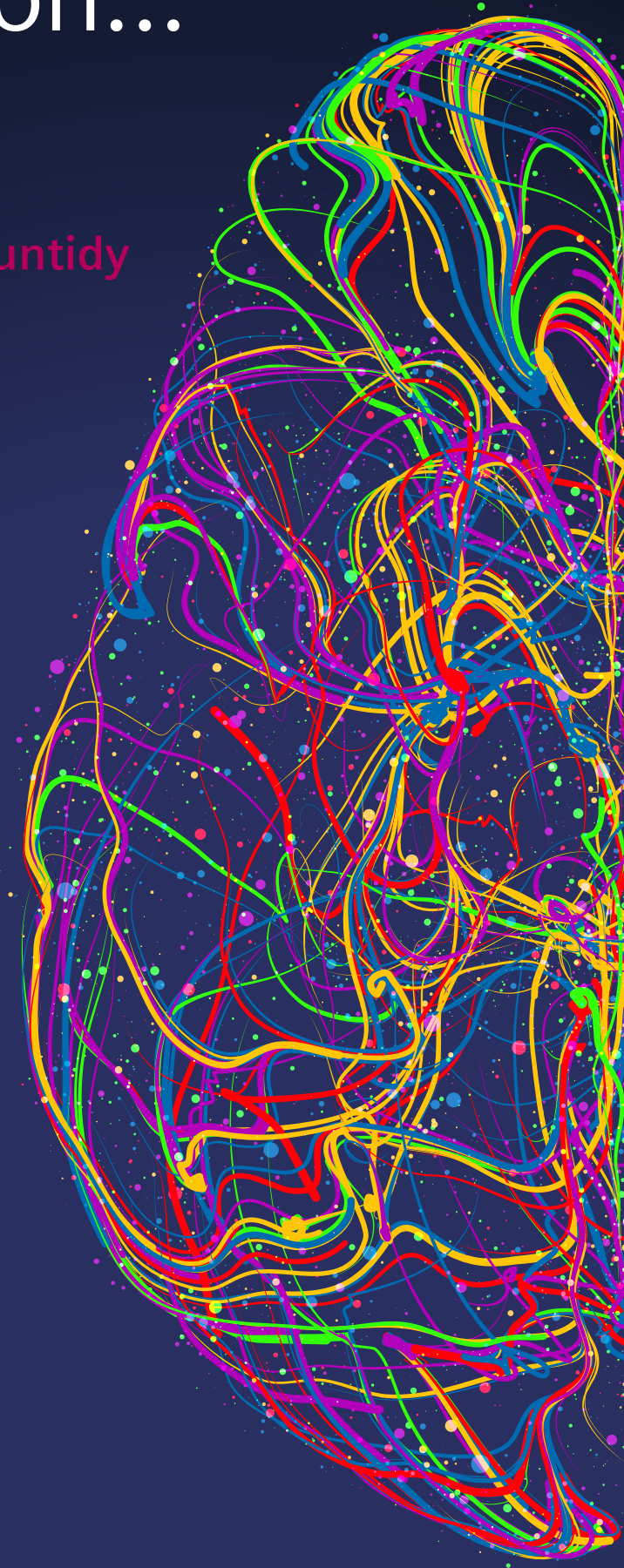

SIEMENS

Ingenuity for life

Siemens Digital Industries Software

The future of engineering

Register for
the 2019
Simcenter
conference



Join us for the 2019 Simcenter Conference
2nd – 4th December 2019
Mövenpick Hotel, Amsterdam City Centre

[siemens.com/simcenter](https://www.siemens.com/simcenter)

Director of publication: Peter De Clerck

Editor-in-chief: Natasha Antunes

Although we make every effort to ensure the accuracy of Engineer Innovation, we cannot be held liable for incorrect information.

© 2019 Siemens Product Lifecycle Management Software Inc.

77875-1 05/19

