



SIEMENS

Ingenuity for life

Siemens Digital Industries Software

Fibersim

Engineering innovative, durable and
lightweight composite structures

[siemens.com/plm/fibersim](https://www.siemens.com/plm/fibersim)

PLY LAYUP TABLE

Name	Seq-Step	Orient	Material
P001	A10	0	TOW-G
P002	A20	-45	TOW-G
P003	A30	90	TOW-G
P004	A40	0	TOW-G
P005	A50	45	TOW-G
P006	A60	0	TOW-G
P007	A70	0	TOW-G
P008	A80	45	TOW-G
P009	A90	0	TOW-G
P010	A100	90	TOW-G
P011	A110	-45	TOW-G
P012	A120	0	TOW-G

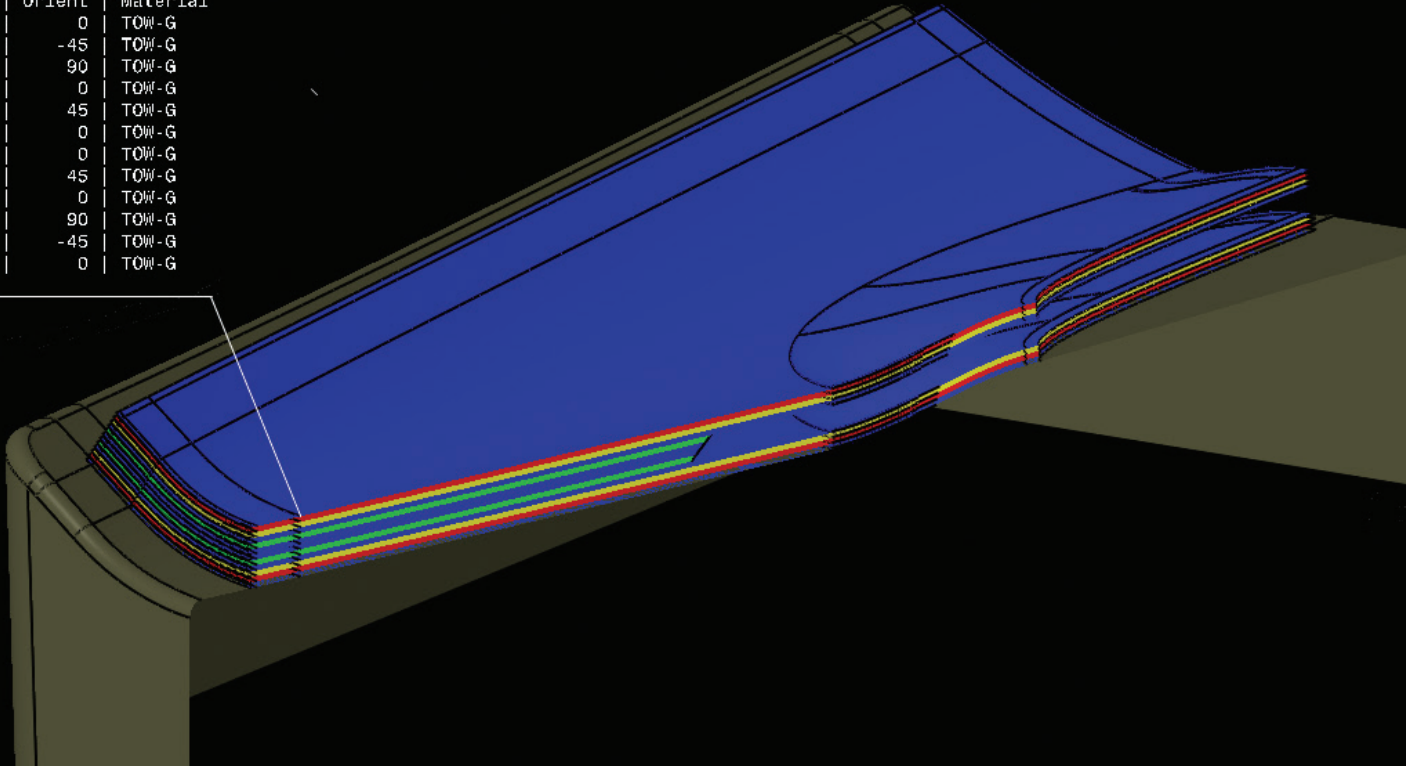

Fibersim software:

- *Supports multiple composite design and manufacturing processes*
- *Automates design definition and change*
- *Features an open architecture that supports multiple CAD systems and best-in-class engineering tools*

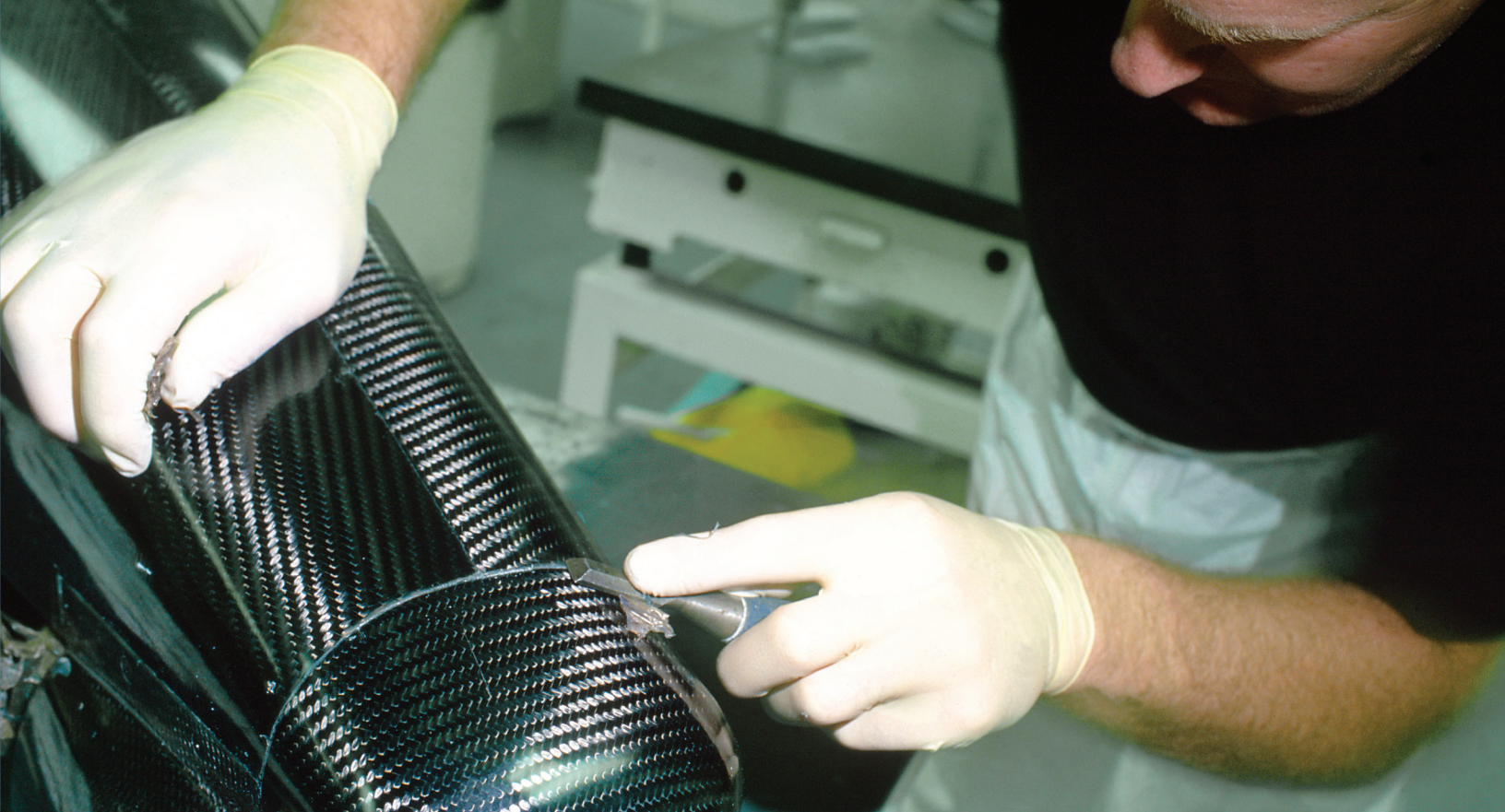

Contents

A specialized problem requires specialized tools	5	Product producibility simulation	14
Addressing the unique needs of collaborative composite product development	6	Manufacturing definition	15
Supporting the entire product development process for composites	7	Manufacturing design detail	16
Preliminary design	8	Manufacturing documentation and automation	17
Ply/core development	10	Product inspection	18
Detailed design definition	12	Integrate the entire composite development process	19
Verify design data	13		

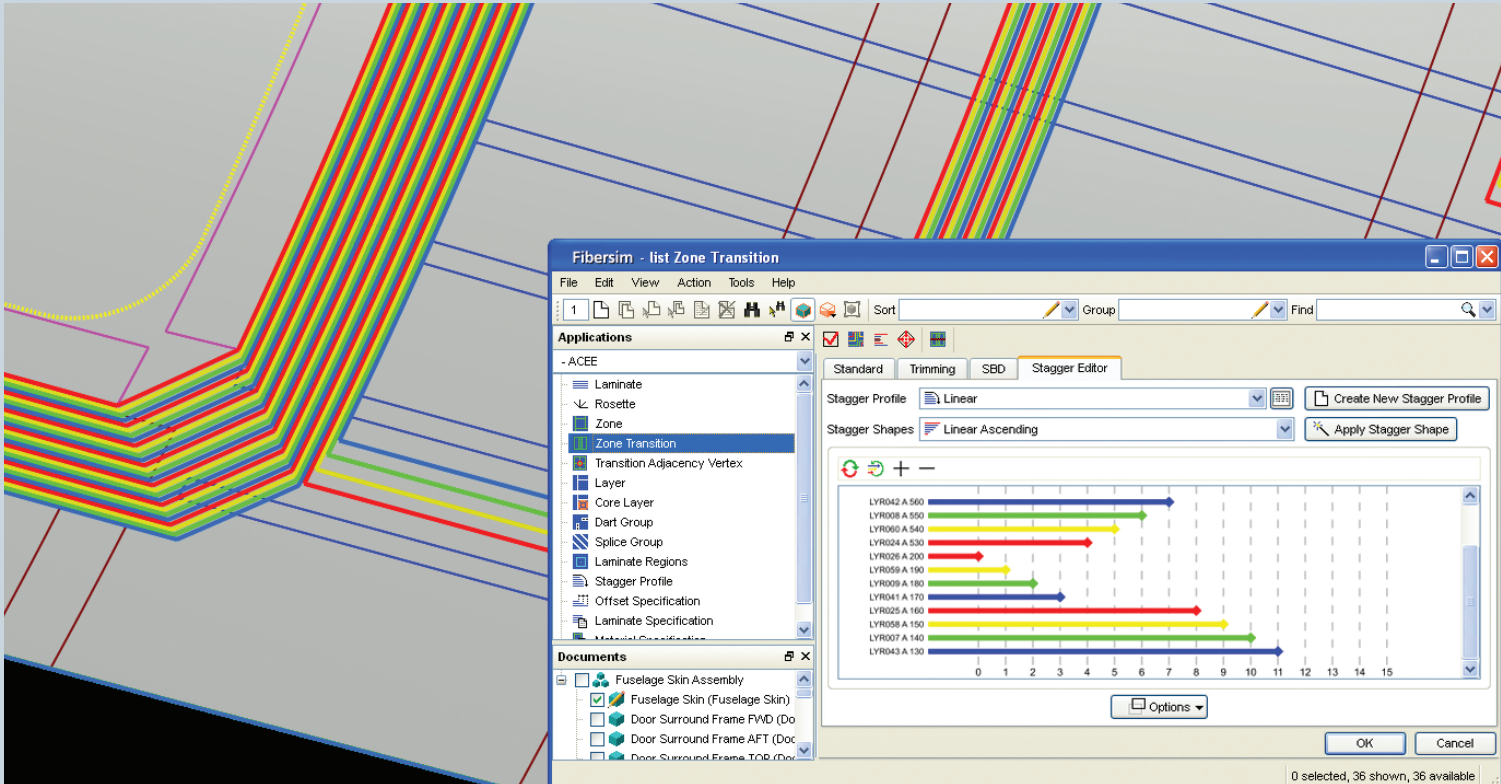

Composite designs are developed from unstructured information, including specifications, standards, attributes and requirements. A single composite part is made up of tens to thousands of unique objects, including core, plies and inserts that must accurately reflect that information in an iterative design-to-manufacturing process. The tasks necessary to define and share this information are both tedious and complex. Such tasks are often not automated or well supported by commercial 3D CAD systems, making them more prone to error. You must accurately interpret and apply specifications or standards, and validate that they meet requirements in order to successfully certify and produce a composite product. This complexity, along

with increasing market demand for innovative composite products that weigh less, cost less and are delivered faster, puts an enormous demand on you and your software systems. So it is critical to have specialized tools that reflect the unique composite terminology and processes used by your industry to develop products that efficiently meet those demands.

That's exactly what the Fibersim™ portfolio of software for composites engineering from Siemens Digital Industries Software provides – specialized solutions for developing high quality composite products efficiently and profitably.

A specialized problem requires specialized tools

Composite design, analysis and manufacturing is complex, specialized work that can best be performed if engineers possess tools that allow them to work how they think with a variety of parameters, including material type, fiber orientation, stack-up order, balance, symmetry, drop-offs, splices and darts. For this nongeometric information to be useful in the product development process, it must create or be associative to geometry so you can view and edit it simultaneously. And to be competitive, you must eliminate painstaking manual creation and management of individual attributes or specifications for tens to thousands of material layers in order to rapidly deliver high performance products.

Let's first consider the composite design phase. Composite design methods are specialized for an industry and product, demanding specific approaches that accurately capture engineering requirements and provide automated tools for creating designs. Whether engineering requirements are based on structural analysis or design for manufacturing, data needs to be accurately and easily captured because attempting to manually create composite laminates that meet specifications is tedious, error-prone and time consuming.

Composite analysis processes are also specialized. Currently, parts are often overbuilt due to the ambiguities in product development and manufacturing. Collaboration between engineering, manufacturing and analysis is required in order to optimize products and exceed performance, weight and cost targets. Analysts must communicate and receive unambiguous feedback about desired fiber orientations and manufacturing process limitations.

And composites manufacturing processes are complex and specialized as well. Only by instituting consistent and repeatable manufacturing processes can a company achieve the goals of reducing composite product costs while enhancing quality and throughput. To do this, manufacturing engineers need an accurate and efficient way to consume the engineering product definition. This demands an automated link between the design, analysis and manufacturing definitions and the systems used in production.

Fibersim specifically addresses these challenges by providing an intelligent design-to-manufacturing composite product development solution that is fully integrated into commercial 3D CAD systems – resulting in products optimized for performance, cost, quality and throughput. The software allows for industry- and part-specific composite development processes that create innovative products that are used from the far reaches of space to the depths of the ocean. It does this by supporting digital, model-based processes that enable optimization, increased efficiency and reduced errors. In addition, Fibersim facilitates collaboration between design, analysis and manufacturing. And its open architecture allows you to develop best-in-class solutions tailored to your product and process and to share essential information among cross-discipline product development teams. Fibersim provides the specialized tools you need to successfully deliver innovative, lightweight composite structures.

Addressing the unique needs of collaborative composite product development



For design engineers, Fibersim facilitates the authoring of composite design data to create a complete 3D product definition. Composite specifications, requirements and intent are associatively linked to the geometry in the 3D CAD model. It provides tools for automating repetitive design tasks, such as applying material requirements and creating ply geometry. This helps you manage design changes during iterative feedback loops with analysis and manufacturing. In addition, the software automates varying levels of visual and data representations to best suit the immediate engineering task and generates a variety of deliverables, such as design documentation, model-based definition formats and enterprise reports.

For analysts, Fibersim facilitates composite product optimization by enabling bi-directional communication between disciplines. Analysts understand that to achieve the full benefit of composites, they must define fiber orientations that provide the greatest structural performance while keeping in mind material and manufacturing parameters. The software allows analysts to communicate the desired fiber orientations to the design and manufacturing engineers and provides feedback to the analyst, including achievable fiber orientations based on the material and process. This results in products that achieve the highest level of part performance and optimization.

For manufacturing engineers, Fibersim facilitates the creation, management and communication of the manufacturing definition by consuming the design data and generating an associative manufacturing model. The software provides tools that automate design for manufacturing, such as splicing, darning and ply edge adjustments for automated deposition based on simulation of the manufacturing process, machine characteristics and materials. It ensures quality composite products by automating the creation of documentation and manufacturing data for nesting, cutting, laser projection, tape laying, fiber placement and inspection. And it communicates the effects of design changes to the manufacturing definition, automatically updating all manufacturing data.

The result is an efficient process for delivering optimized composite products.

Supporting the entire product development process for composites

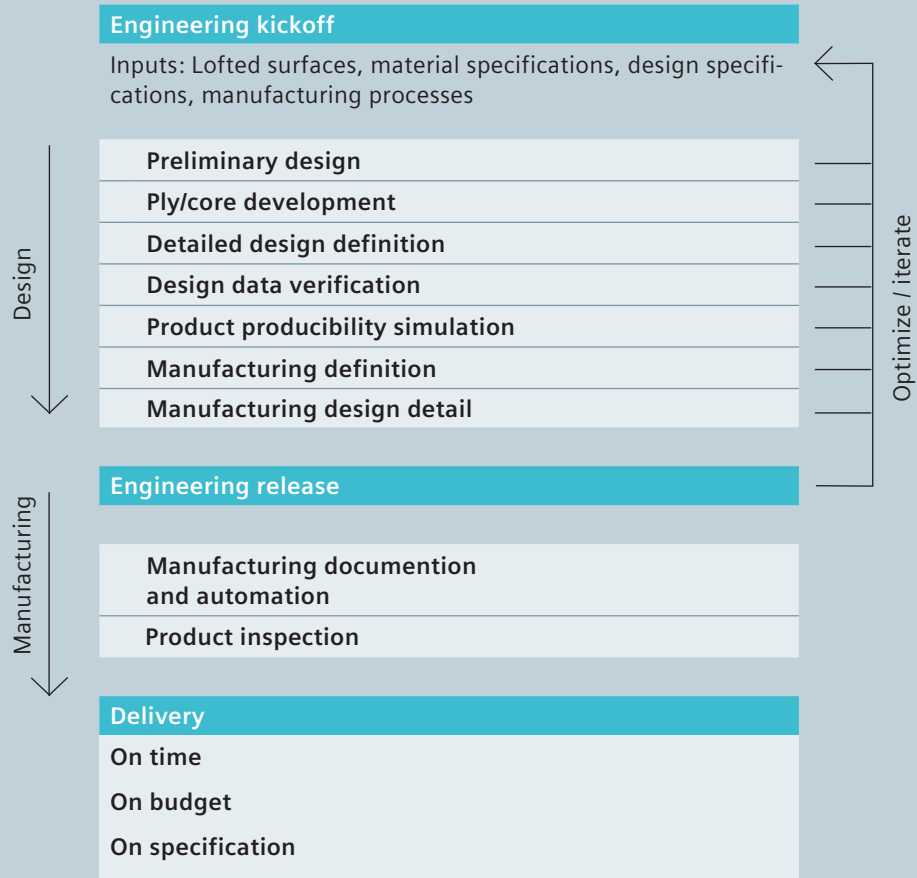

Preliminary design

Closing the loop between composites design and analysis

Key functionality

- Ply data export to CAE software, including true fiber orientations that result from Fibersim producibility simulation
- Ply data import from CAE software, including ply shapes and specified orientations
- Core data exchange
- Zone data exchange, including laminate specifications

Benefits

- Optimized design resulting from more design and analysis iterations completed in less time
- Reduction in time wasted on clarifying communication and correcting errors
- Improved design reliability based on more accurate failure and durability analysis
- Less overdesign and better control over margins of safety and part performance assessment

Traditionally, the preliminary design process entailed a time-consuming exchange of documents multiple times between the designer and analyst to agree on an initial optimized part definition.

Engineers can now use the Analysis Interface module in the Fibersim portfolio to rapidly import the CAE model data directly into Fibersim to help design the part in the CAD system. The Analysis Interface also enables export of detailed design data back to CAE software for more accurate part analysis.

While Fibersim has many tools to assist the designer in achieving the initial design specifications provided by the analyst, the final design may still differ significantly from the idealized part that was analyzed. For example, the final design may contain additional plies that were not considered in the original analysis. Prior to the existence of the Analysis Interface, the true performance of the final part was therefore never precisely known.

The Analysis Interface addresses this problem by enabling engineers to design a composite part in the CAD system, determine the state of the manufactured part using simulation technology and then use the as-manufactured definition as input into the CAE system for validation analysis.

Closing the loop between the Fibersim designer and the CAE analyst allows companies to eliminate the practice of part overdesign that so often defeats the original purpose of using composites.

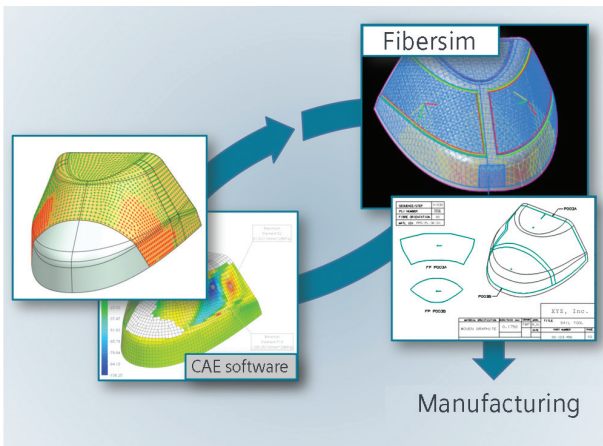

The Analysis Interface drives analysis from the same single CAD master model that is used for design and manufacturing. This permits analysis to be performed on a part in its to-be-manufactured state.

Ply/core development

Efficiently developing plies and cores with product-specific automated processes

Key functionality

Industry- and product-specific composite ply and core development processes, including:

- Material requirement and ply import
- Ply design
- Zone- and grid-based design
- Structure-based design
- Wind blade design import
- Volume fill

Benefits

- Enriches industry- and product-specific product development processes
- Reduces ply development time by as much as 80 percent
- Provides collaborative and rapid iterations between cross-discipline product development teams
- Promotes data re-use from specialized tools used by other disciplines, eliminating ply and core development errors

Efficient and accurate development of plies or cores requires a deep understanding of the collaborative design processes used for creating composite products. Based on over 20 years of experience in commercial aerospace, automotive, defense, marine, wind energy and other industries, we understand that a “one size fits all” approach doesn’t work for composites. Fibersim features an open architecture that allows for sharing data in cross-discipline teams in the most appropriate manner for your industry and product.

For example, an aerospace wing skin panel, automotive B-pillar, wind turbine blade and jet engine fan blade all require an efficient and automated composite product development approach within a 3D CAD environment. Fibersim facilitates this by providing:

- Structure-based design tools that support commercial aerospace wing skin panel engineering processes in which development is based on material requirements defined by analysis and ply relationships to the mating substructure
- Analysis or Excel ply imports supporting automotive B-pillar engineering processes in which development is based on rapid iterations that balance product geometry and structural performance

- Wind blade design tools that support the turbine blade development process in which blade shells are developed based on preliminary design data and material location with respect to the blade spine, root and tip
- Volume fill functionality that supports jet engine fan blade product development processes based on material requirements defined by analysis and the need to fill the volume between high-pressure and low-pressure aerodynamic surfaces

Supporting rapid changes during design requires consistently defining and managing up to 150 attributes, such as material type, mechanical properties, orientation, width, thicknesses, weight, cost and layup order. Keeping up with this during the iterative development cycle is tedious and error-prone. Fibersim ensures accuracy by generating attributes during development and provides organization and modification capabilities en masse. The management capabilities and materials database ensure that attributes are assigned consistently across an organization.

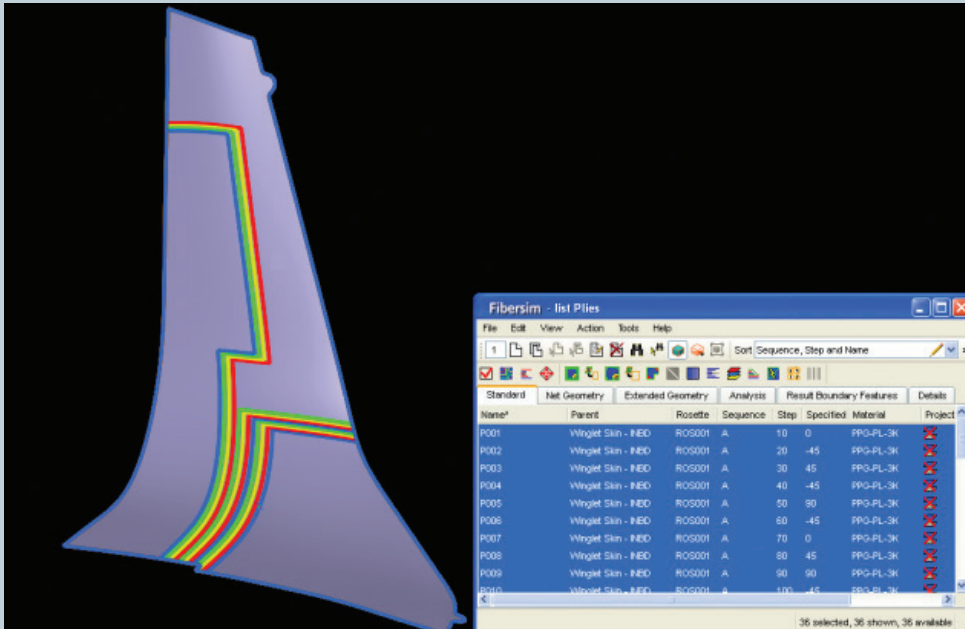

The Fibersim Excel import capability creates all of the plies from the imported Excel spreadsheet containing ply names, materials, orientations and CAD ply boundary names. Plies highlighted in Fibersim are displayed in the CAD model. Plies are indicated by blue-0°, green-45°, yellow-90°, red-45°.

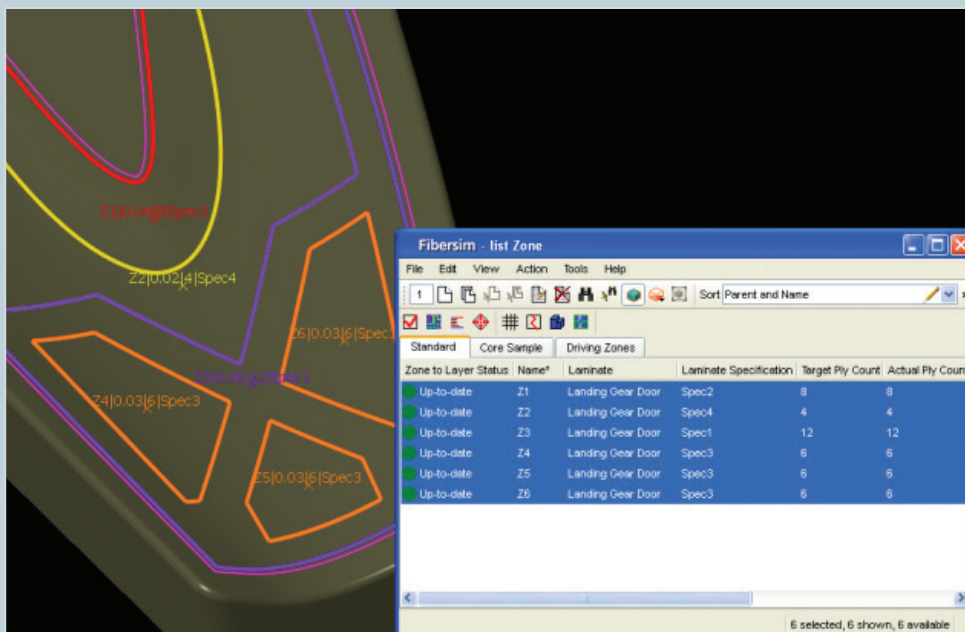

The Fibersim zone-based capability defines material specifications for specific areas of the part called zones. Zones highlighted in Fibersim are displayed within the CAD model in a user-defined color with text indicating the zone name, zone thickness, number of plies and specification.

Detailed design definition

Automating detailed design by incorporating engineering specifications and standards

Key functionality

- Ply drop-off
- Stagger profile
- Offset specification
- Stagger editor
- Ply corner treatment

Benefits

- Reduces cycle time for detailed design
- Eliminates interpretation and errors relating to the engineering specifications and standards
- Improves design change cycle times by up to 90 percent
- Reduces engineering change orders resulting from violations of engineering specifications

Myriad engineering specifications and standards dictate detailed design definition, including drop-off locations and profiles, ply corner treatments and feature or component relationships. Iterative changes throughout the development process make it very difficult to ensure adherence. Fibersim helps you adhere to engineering requirements by incorporating specifications and standards into the design, including ply drop-offs, stagger profiles, stacking and more, which automate creation of design details and associated geometry, such as ply boundaries and offset surfaces.

You must manage assembly component and composite feature relationships to ensure engineering requirements are met. For example, specifications may require ply drop-offs to be offset in a specific manner. Fibersim directly incorporates these relationships to ensure adherence to specifications.

Due to the vast number of composite features, it is easy to inadvertently violate standards and specifications during change processes. Fibersim removes the risk of error and reduces tedium by identifying affected features and modifying attributes or associated geometry. You can modify the specifications or standards and leave the modification of affected composite features and geometry to Fibersim.

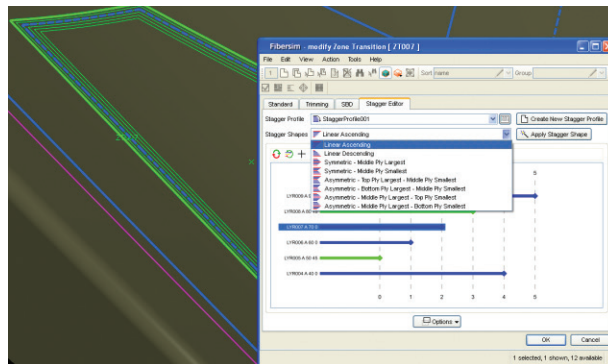

Fibersim zone transitions provide an automated way to create the desired drop-off profile by either using stagger shapes or dragging and dropping plies to the appropriate ply boundary.

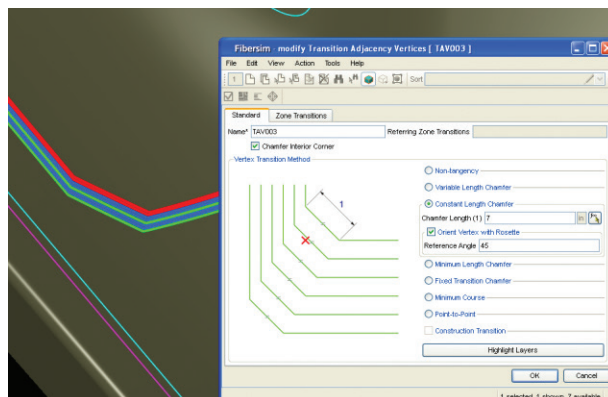

Modifying ply corners is as simple as selecting the desired chamfer or shape in Fibersim using its intuitive interface that immediately updates ply boundaries.

Verify design data

Verifying designs with automated documentation

Key functionality

Automate the creation of composite engineering documentation and laminate representations for design verification, including:

- Analysis interface
- Annotations, including:
 - > Core sample
 - > Ply table
 - > Material table
 - > Ply callout
 - > Cross sections
 - > Stepped solid
 - > Zone solid

Benefits

- Reduces time to create engineering documentation
- Ensures accurate, up-to-date documentation
- Eliminates errors associated with manual creation of engineering documentation
- Ensures accurate solid and surface composite part representations

Design verification is critical in a collaborative product development process. Design changes to the standards, specifications and attributes pose risks to fulfilling product requirements and meeting targets. Review of each aspect requires visibility into the composite features, laminate and assembly relationships.

Engineering documentation brings visibility to the composite details during verification, including drop-off profiles, ply order and ply materials. Fibersim helps automate the creation of cross sections, annotations and core samples that are updatable as changes occur, ensuring the design is accurately reflected. Fibersim core sampling capabilities provide deeper details, such as ply thickness changes, fiber deviation, balance and symmetry, which are invaluable in ensuring product quality.

Understanding laminate weight and cost is critical to making go/no-go decisions during verification. Fibersim instantly provides the laminate weight and cost, including post cure processes, to provide the most accurate information during review.

Assembly relationships, such as packaging and clash detection, are an important aspect of design verification as well. Fibersim automatically creates surface and solid representations that allow you to detect clash between assembly components and ensure that packaging requirements are met.

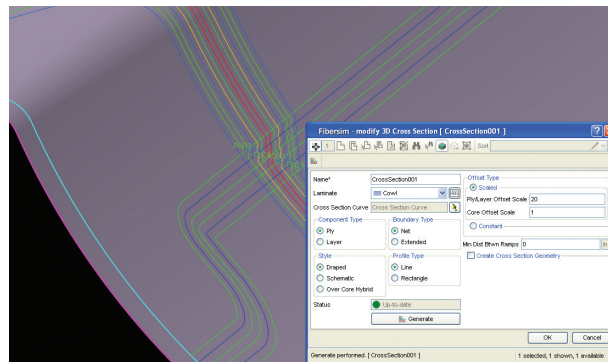

Fibersim cross sections are automatically created with a push button operation and are associative to the design, eliminating manual effort and ensuring accuracy.

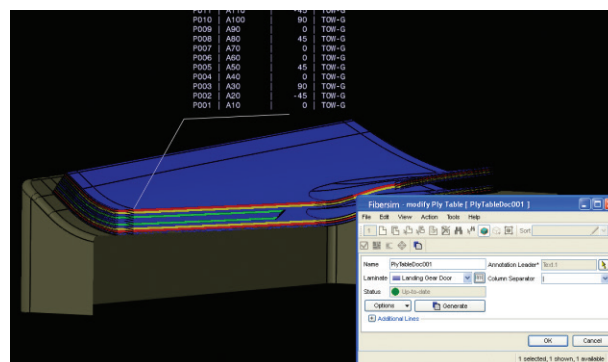

Fibersim exploded laminate and annotation capabilities provide an instantaneous method for creating surface representations of the stack-up and annotations that are updatable as the design changes. Plies are indicated by blue-0°, green-45°, yellow-90°, red-45°.

Product producibility simulation

Ensuring design and production optimization with unparalleled simulation capabilities

Key functionality

Unparalleled simulation capabilities required to balance product shape, material and manufacturing process decisions, including:

- Spine-based with localized deformation
- Non-crimp fabric with fiber buckling
- Curvature adaptive
- Formed laminate
- Material propagation
- Multi-stage
- Course challenges

Benefits

- Enables efficient design-for-manufacturing process by taking into consideration machine limitations
- Promotes greater quality with simulations for products and manufacturing processes
- Increases the opportunity to optimize composite parts by eliminating ambiguities in the development process and understanding true manufactured fiber orientations
- Ensures expected structural part performance

Knowing how materials conform to part shapes during manufacturing is crucial to producing high quality composite products. Fibersim provides unparalleled capabilities to help you balance material, shape and manufacturing process decisions to create optimized products.

Fibersim allows you to simulate materials, such as woven fabrics, uni-directional tape, tow and multi-axial fabrics, with respect to the manufacturing process, such as hand or multi-stage layup, fiber steering, forming and automated fiber placement or tape laying. Uniquely, the simulation uses the actual 3D part geometry to provide the most accurate feedback. Simulations can be done ply-by-ply or en masse, providing rapid feedback via a

color mapped visualization that displays where fiber deformation or deviation, shearing and fiber buckling exceed acceptable limits. True fiber orientations can be passed to CAE software so analysts can optimize parts.

Automated tape laying and fiber placement require attention to machine characteristics like minimum material width and minimum cut length/angle/width. The integrated machine database and course challenge capabilities within Fibersim provide feedback to ensure that designs for automated manufacturing are producible.

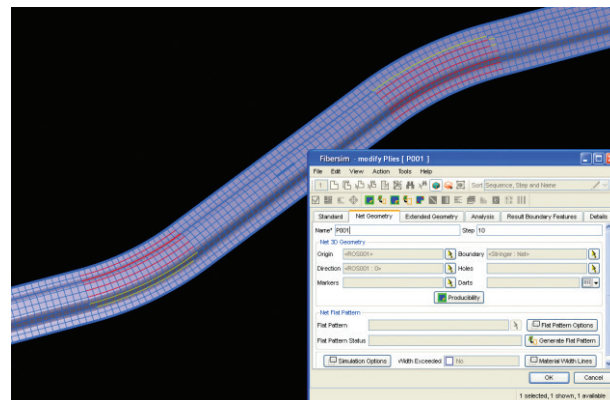

The Fibersim spine-based simulation is the only solution that allows you to identify areas of localized deformation (highlighted in yellow and red) that are caused by part curvature and fiber steering during manufacturing.

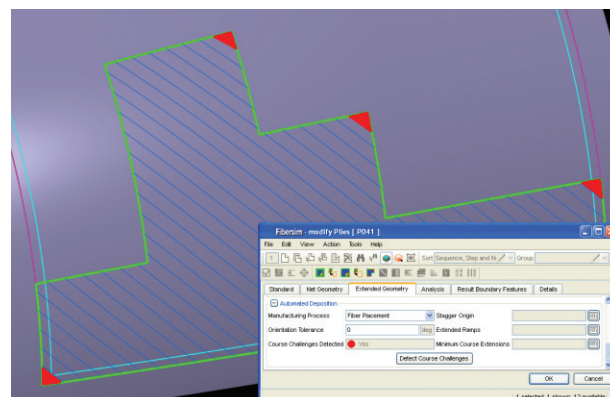

The Fibersim machine database and its course challenge detection simulation allow you to identify design issues due to automated fiber placement and automated tape laying machine characteristics, including minimum courses (highlighted in red) and shallow cut angles.

Manufacturing definition

Automating generation of composite manufacturing definitions and tooling

Key functionality

Model-based approach for developing the manufacturing definition and consuming the design data, including:

- Parametric surface offset
- Manufacturing laminate
- 2D laminate
- Skin transfer

Benefits

- Eliminates manual methods for creating tooling and manufacturing definitions
- Reduces time and error in tooling creation that can cause program delays
- Ensures traceability and adherence to composite engineering specifications and standards from design to manufacturing

Unique composite manufacturing definitions are required to properly represent the manufacturing process and maintain the integrity of the composite design. Establishing appropriate manufacturing definitions is challenging, ranging from consumption of the composite design to the creation of inner mold line (IML) tooling. These challenges pose risks for errors and delays in time-to-market.

In fact, creating IML tooling is often the greatest challenge. With the engineering definition often completed on the composite part outer mold line (OML), you need to accurately represent IML tooling based on material thicknesses and drop-offs.

Traditionally, creation of composite manufacturing representations, such as IML tooling, required significant manual calculation

and design data redefinition, often resulting in incorrect tooling and introductions of errors. Fibersim helps automate the creation of IML tooling and the tooling representation consumption of the engineering definition.

Sustaining a collaborative product development process, Fibersim maintains associativity between the engineering and manufacturing definitions after the design data has been consumed. Manufacturing design details can be defined and design changes tracked and shared so that either definition can be automatically updated.

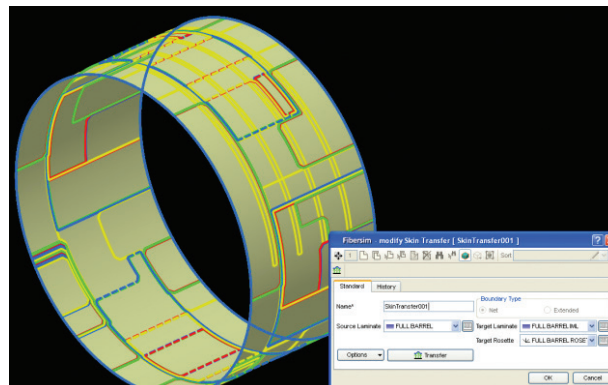

Fibersim parametric surface offset capabilities make it easy to create IML tooling (tan surface) and update it with design changes. The skin transfer capability automatically transfers the plies from the design definition (blue, yellow, green and red curves) to the manufacturing model.

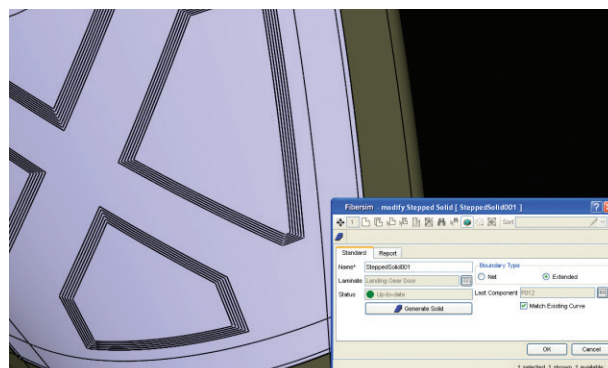

Fibersim provides a rapid method for assessing packaging and clash by automatically generating a stepped solid (gray) representation.

Manufacturing design detail

Enabling composite design for manufacturing that increases production

Key functionality

Intelligently automated generation of composite design for manufacturing features, including:

- Splicing
- Darting
- Flat pattern generation
- Course generation
- Minimum course vertex
- Extended ramps

Benefits

- Increases production throughput by ensuring that all production challenges are addressed before manufacturing
- Reduces labor costs by cutting material touch time required for layup
- Reduces unnecessary material scrap by taking into consideration machine limitations during design

To ensure products meet specification and cost targets, you must address production issues prior to release to manufacturing. Waiting to resolve issues can reduce the advantages of using composites by increasing production time, labor costs and material scrap. Fibersim addresses these challenges and maintains a collaborative product development process by updating the design with manufacturing design details.

Resolving material deformation, deviation and fiber buckling before layup reduces touch time and increases manufacturing throughput. Fibersim does this with flexible, automated splicing and darting capabilities. Incorporating specifications, including staggered splicing, splice overlap, no-splice region and no-dart region, helps automate creation and ensures requirements are met.

You must address automated deposition machine characteristics, such as minimum cut length and roller height travel, in the design to ensure optimal machine rate and throughput. Minimum cut length limitations require material additions to the ply boundary, often added manually in path planning software or by hand during manufacturing. Roller height travel limits can cause material smear at the "cliff" edge of parts, often addressed by stopping the machine and manually shimming the part edge. Fibersim automatically identifies design for automated manufacturing requirements and applies ply boundary adjustments to maintain an accurate engineering and manufacturing definition.

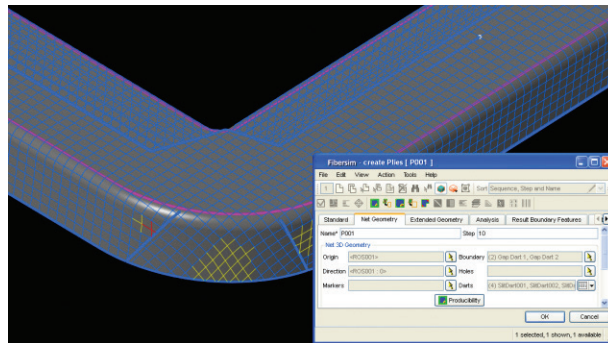

Fibersim provides automated methods for addressing manufacturing challenges. Darts, displayed as the two blue curves in the bend, are created while viewing material deformation.

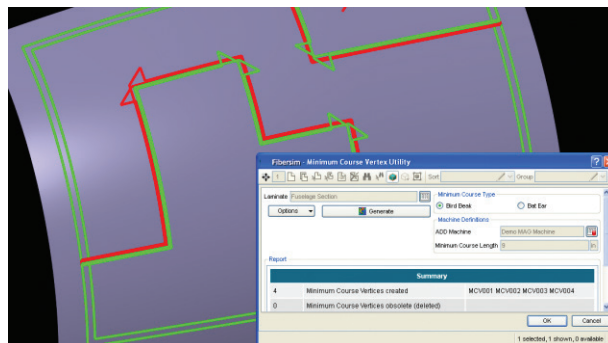

The Fibersim minimum course utility automatically identifies corners where material additions are required to ensure minimum courses can be laid up during automated fiber placement.

Manufacturing documentation and automation

Delivering accurate design data to the manufacturing floor

Key functionality

- Layup plybook
- Flat pattern export
- Laser projection export/import
- Automated tape laying export
- Automated fiber placement export/import
- Publish Fibersim Composite Format

Benefits

- Eliminates the need to manually create manufacturing documentation for hand layup processes
- Increases production throughput and quality by removing the ambiguity in hand layup manufacturing processes
- Seamlessly transfers design data to automated production systems

The highest quality, lowest cost product requires repeatability of the manufacturing process. You can achieve this by using accurate information, eliminating ambiguity and increasing the use of process automation.

Repeatability of the hand layup manufacturing process can be ensured by eliminating the manual creation and digitization of ply templates, incorporating laser assisted layup and creating process documentation that removes ambiguity. Automated tape laying and fiber placement ensure repeatability and eliminate ambiguity, but the composite definition is often manually created for path planning and post generation.

Fibersim helps you quickly and accurately create documentation and data directly from the composite manufacturing representation, ensuring that the documentation and automated production system data are always current and accurate.

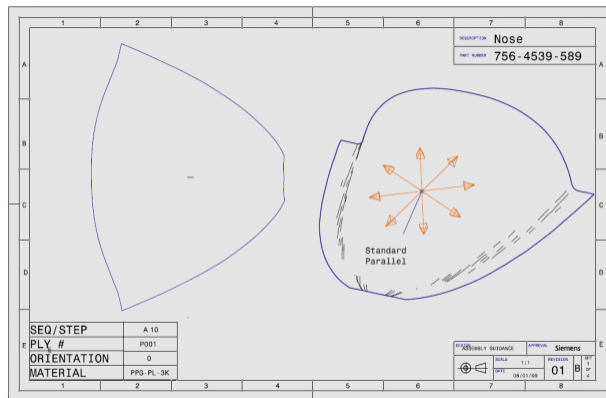

Fibersim generates plybook documentation needed for hand layup, which ensures repeatability and part quality by displaying the layup process.

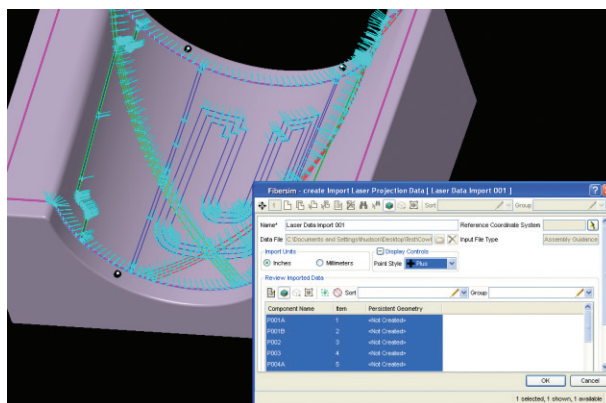

Fibersim manufacturing interfaces support myriad manufacturing processes, including automated cutting, automated fiber placement, automated tape laying and laser projection.

Product inspection

Verifying that composite parts meet specifications

Key functionality

Automatically generates composite engineering data for plans that support the first article inspection (FAI) process, including:

- Plies
- Cores

Benefits

- Reduces time to generate quality inspection plans for composite products by as much as 90 percent
- Delivers more thorough and accurate quality reports, resulting in less documentation rework

Inspection is a critical part of the composite product certification process. First article inspection plans and automated inspection ensure accurate execution of the inspection process. Together with the Quality Planning Environment (QPE) software for developing plans to assess aerospace quality from Siemens, Fibersim can be used to generate quality plans and drive automated ply verification systems for inspection.

You can import Fibersim composites data into QPE and arrange it in a standard inspection format. QPE then completes additional portions of the quality plans, such as dimensions, notes and balloons on items to be inspected. QPE stores the inspection plan in an associated quality model, which you can export in a standard inspection plan format as needed. Alternatively, you can import an XML export into computer-aided process planning (CAPP) systems.

Producing the highest quality composite products requires that material, orientation, location and order are correct during the manufacturing process. The required inspection is a time-consuming and costly manual process. Fibersim supports efficient automated ply verification (APV) systems by directly using design data during inspection. You can import the Fibersim composite definition into an APV system, which uses a high-accuracy, manually positioned inspector to verify ply edges, location, material type and fiber orientation within specified tolerance and ply sequence.

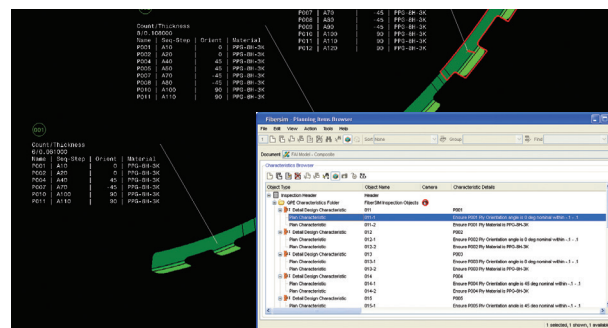

QPE automatically creates inspection characteristics – such as material type and ply orientation – for a shear tie of a composite fuselage based on ply information created in Fibersim or data extracted from specification tree formats or databases.

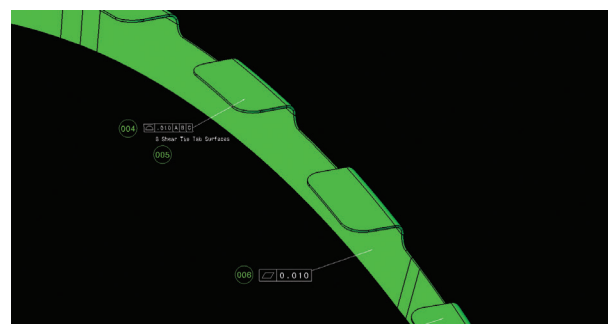

Dimensions, tolerances and notes defining design characteristics of the laminate are consumed into the QPE to provide a complete set of pre- and post-cure inspection requirements.

Integrate the entire composite product development process

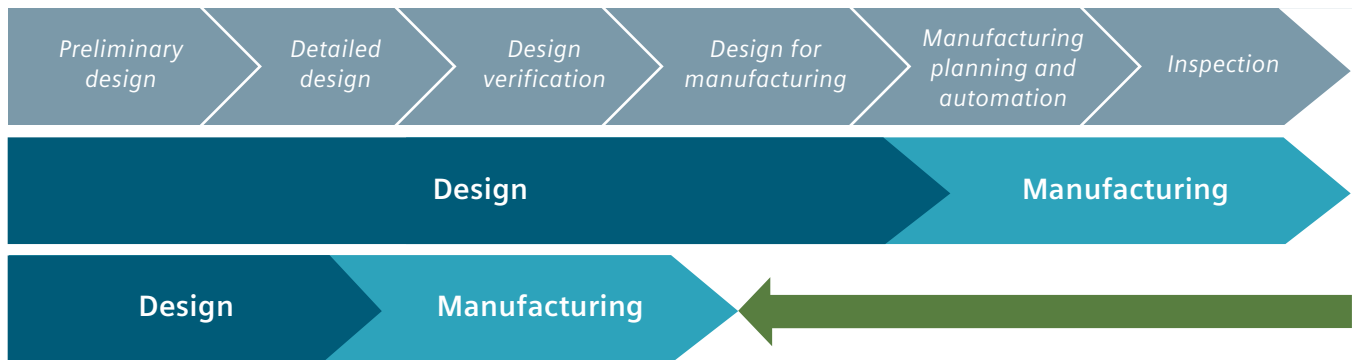

Fibersim compresses the design-to-manufacturing process for composite components by up to 45 percent.

Fibersim delivers:

An open architecture that facilitates a collaborative composite product development process

As much as 80 percent time savings to create composite designs

A reduction in time to make design changes by as much as 95 percent

Adherence to composite engineering specifications and standards

Confidence in product performance by eliminating ambiguity in desired fiber orientations and providing feedback on true fiber orientations

Successful composite product development requires effective communication among multi-discipline teams throughout the lifecycle of a product. Fibersim transforms – and ultimately reduces – the entire composite product development process by providing an open architecture that allows concurrent engineering and easy exchange of information between analysts, designers and manufacturing engineers. It automates the tedious design and iterative tasks associated with making changes – all while ensuring awareness of the impact of those changes – so composite products can be developed faster and without errors. Fibersim also improves product quality and throughput time by delivering automated manufacturing and inspection data directly from the design to the factory floor, ensuring a repeatable manufacturing process. The combination of these unique features makes Fibersim the best tool available to deliver innovative, optimized composite products that meet all specifications, on time and within budget.

“The quality of manufacturing data provided by Fibersim is better than anything our supplier has ever had.”

*Ian Goddard, Senior CAE Engineer
Lotus F1 Team*

About Siemens Digital Industries Software

Siemens Digital Industries Software, a business unit of Siemens Digital Industries, is a leading global provider of software solutions to drive the digital transformation of industry, creating new opportunities for manufacturers to realize innovation. With headquarters in Plano, Texas, and over 140,000 customers worldwide, we work with companies of all sizes to transform the way ideas come to life, the way products are realized, and the way products and assets in operation are used and understood. For more information on our products and services, visit [siemens.com/plm](https://www.siemens.com/plm).

Headquarters: +1 972 987 3000
Americas: +1 314 264 8499
Europe: +44 (0) 1276 413200
Asia-Pacific: +852 2230 3333

© 2019 Siemens. A list of relevant Siemens trademarks can be found [here](#).
Other trademarks belong to their respective owners.
29555-C51 6/19 A