



SIEMENS
Ingenuity for life



Siemens Digital Industries Software

Automotive end-of-line testing

Leveraging an innovative quality inspection system to improve noise and vibration

Executive summary

Traditionally, analyzing vibration and noise is part of developing mechanical components in the automotive industry. The object is to optimize noise for quality and comfort. Although the performance and reliability of current vehicles is generally high, noise, vibration and harshness (NVH) strongly influences the customer's purchase decision.

Safeguarding high noise and vibration standards implies there are appropriate inspection systems to assess that criteria on the production line. Therefore, noise and vibration inspection systems can be used to ensure high quality while simultaneously helping reduce costs. This white paper describes the underlying concepts of an innovative NVH-based quality inspection system.

Abstract

Vibro-acoustic assessment in end-of-line testing of automotive components, like engines, transmissions, steering components and electric motors, has become a fixed part of today's quality assurance concepts. That's because of the requirement for an objective test for NVH-related issues.

Initially seen as an effort to provide additional data obtained during the test, this information offers the chance to improve the quality standards of the production line. In addition to being able to rapidly amortize vibro-acoustic testing, the supplier strengthens its position with original equipment manufacturers (OEMs) by adhering to a high-quality standard.

Based on these objectives, we describe how the measurement chain is defined based on physical relationships in the vibration and noise generation as well as the feature extraction. We discuss how the relatively complex vibro-acoustic test for the production line is managed.

Objectives

A well-defined test system takes into account demands for quality and strategic enhancements.

Vibro-acoustic quality

The vibro-acoustic quality control of components is usually introduced with the aim of sorting out specimens that do not meet noise and vibration behavior requirements.

The definition of quality requirements is often based on the subjective perception of noise or vibration test subjects. Based on the requirements of the vehicle manufacturer's specifications and quality standards, model values for measurable vibration or noise components are specified. Phenomena that are not significantly reflected in classically definable waveforms and measures are described by special limit patterns. This implies a jointly coordinated test method.

Quality enhancement

On the supplier side, introducing vibro-acoustic testing means additional expenses. Suitable methods, however, provide parallel criteria for evaluating the noise involved in the formation of the components being tested. This allows the user to identify faulty components. Using this information directly reduces the expense of reworking. Statistically analyzed, specific actions are used to effectively increase the overall quality of the production process.

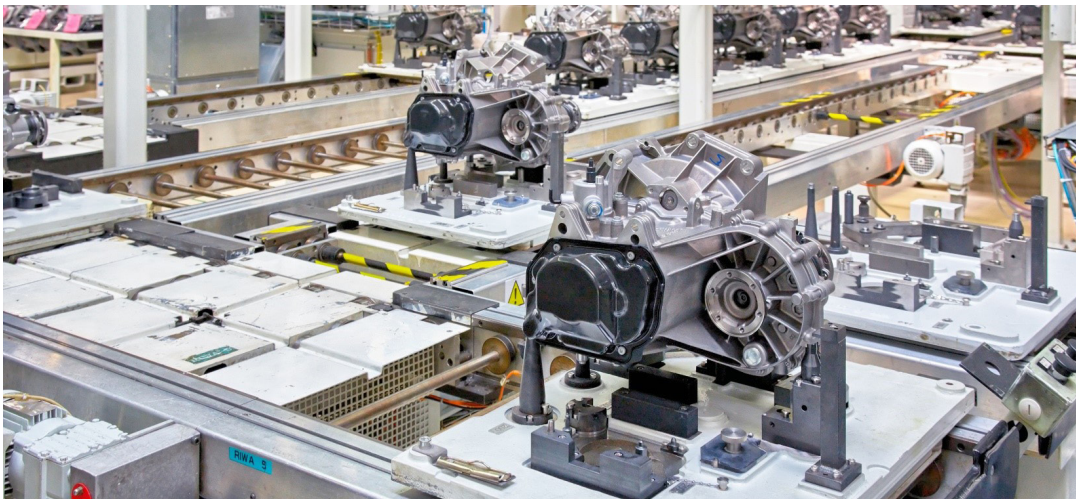

Figure 1. End-of-line test of transmissions is a traditional application for noise- and vibration-based quality inspection. Major quality criteria are based on a noise and vibration assessment.

From subjective quality criteria to objective measures

The customer requirements for vibration and sound quality are included in the test concept of the supplier. Based on specified characteristics and limit patterns, the spotlight is first put on the test setup and then on the testing regime and sensor concept. Then the classical features of vibration and noise assessment are considered.

Test setup

Usually a functional test rig is used, which must be extended for vibro-acoustic testing.

For vibration and noise measurements, this is rarely optimal for measurement purposes. Above all, installing optimized vibration or acoustic test benches at the production line is usually not done due to cost constraints. Even compared to the mounting position in the vehicle, there are differences that affect the specified vibration and noise characteristics. In general, a noise and vibration test bench must meet the demands of gauge capability. Requirements for repeatability, vibration and noise isolation are guaranteed by a detailed measurement systems analysis (MSA). It is also possible to test components with low noise emission at the production line.

For example, vibration acceleration levels of about

$$70 \text{ decibels (dB)} \left(\frac{m}{s^2} \right)$$

are measured reliably at steering components for a given noise level of about

$$50 \text{ dB} \left(\frac{m}{s^2} \right).$$

The limits of quality measures that have been specified under laboratory conditions or at the vehicle have to be adapted to the changed environmental conditions in the test bench.

Test regime

For evaluating noise and vibration phenomena, the testing regime should be like the in-vehicle use; for example, regarding the operating load. Deviations from this principle are possible if all factors that significantly affect the vibration and noise characteristics are known. Then the desired behavior in the operating point of interest can be calculated from the measured behavior in the test bench environment. Compensation models, particularly in terms of their dependence on material properties, are usually quite complex.

Sensor concept

Test bench vibration and noise can both be measured reliably in end-of-line testing. It takes far less effort to design a test bench for vibration measurement than designing a reliable measurement for airborne sound. Since the emitted noise is caused by the vibrations of the specimen, a noise measurement often can be replaced by a vibration measurement.

Features for noise and vibration assessment

The simplest approach is certainly the use of sound pressure level,

$$L_p = 20 \log_{10} \left(\frac{p}{p_0} \right) \text{ dB}; \quad p_0 = 2 \cdot 10^{-5} \text{ Pa}$$

or the vibration acceleration level.

$$L_a = 20 \log_{10} \left(\frac{a}{a_0} \right) \text{ dB}; \quad a_0 = 1 \cdot 10^{-6} \frac{m}{s^2}$$

Both measures assess the overall signal. Due to the current quality of vehicle components, both parameters are practically useful only to a limited extent.

Third-octave spectra allow a frequency-selective evaluation, while easily providing a limit definition based on vehicle requirements.

If an evaluation of the sound quality based on signal amplitudes and amplitude ratios is not possible, psychoacoustic parameters can be used. It should be noted these characteristics require a precise definition of test conditions due to nonlinearities. Psychoacoustic parameters are defined only for airborne sound.

The following pictures show an example of how an error manifests itself at a test specimen in the acceleration level, the third-octave, frequency and envelope, as well as in psychoacoustic parameters of roughness.

The error has little effect on the overall level. Limits are difficult to define.

In the third-octave spectrum the effects of the error can be seen. The frequency and amplitude characteristics of the abnormal noise can be described. Statements about the cause are not possible.

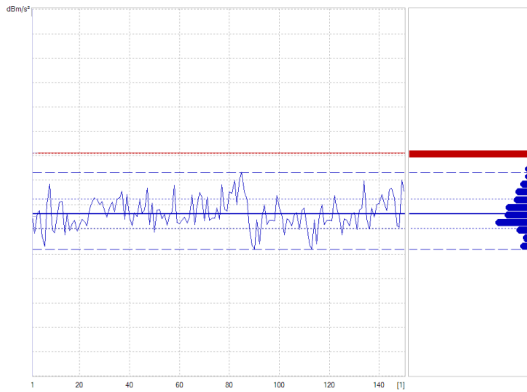

Figure 2. Vibration acceleration level of production (blue), fault (red).

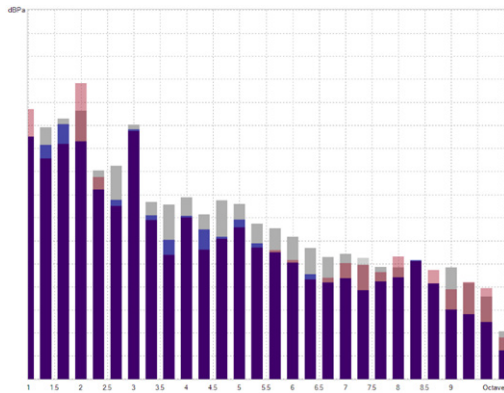

Figure 3. Third-octave-spectrum production (blue), fault (red).

Frequency and envelope spectra allow the assignment to the component and a description of the error.

The psychoacoustic parameter roughness allows safe detection of the error based on the airborne sound. Error identification is not possible.

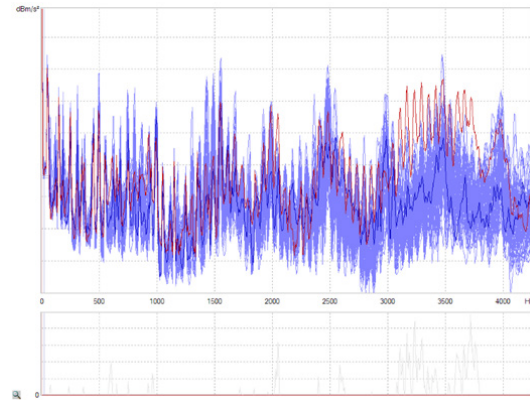

Figure 4. Frequency spectrum sideband lines of gear mesh orders in the event of an error (red) compared to production (blue) allow assignment to the component.

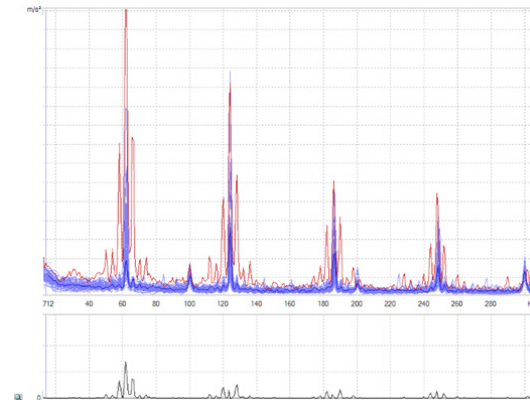

Figure 5. Envelope spectrum, information about the modulation in the case of an error (red) to production (blue).

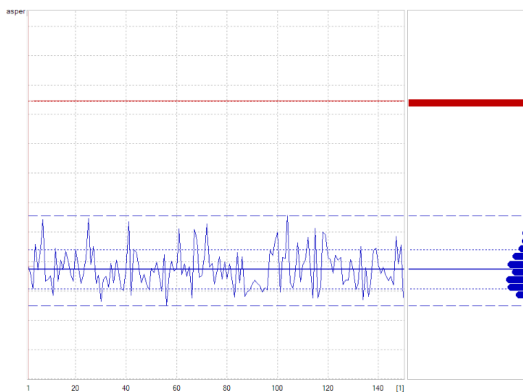

Figure 6. Roughness production (blue), fault (red).

Expansion of the assessment features for fault identification

Causes of noise are always vibrations. These are caused by transient excitations or periodically varying forces that occur during normal operation and lead to the typical operating noise. Deviations from the normal noise only occur if atypical oscillations occur caused by changes in the dynamics. This applies to all phenomena, even if they are writable only; for example, by psychoacoustic parameters.

If the assignment of an abnormal noise to a certain part of the device being tested is possible, the cause is identifiable. The feature definition is based on a kinematic or physical model of the component to vibrational origin.

Depending on their cause, the oscillations have typical signal characteristics. These are distinct from other vibration components, a suitable method for the isolation provided.

The choice of an appropriate signal processing method for fault identification is directly related to the characteristics of the signal:

- Periodically or transient
- Harmonic-bound
- Time or angle synchronous
- Modulations

For feature extraction useful test systems provide several suitable signal processing algorithms such as spectral analysis, order spectral analysis, envelope analysis, angle-synchronous averaged envelope, sideband analysis or angle-synchronous cepstrum analysis.

In contrast to the pure noise assessment methods, algorithms and features usable for error identification provide a high selectivity in the frequency, order or angle-time domain. This is necessary for separating signal components of many different parts of the specimen.

A useful test system allows the flexible configuration of different signal processing methods in parallel to each other.

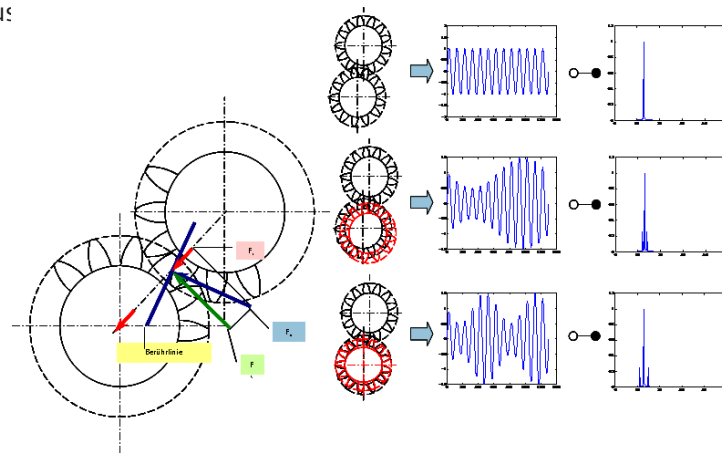

Figure 7. The kinematics of meshing determines the resulting oscillations.

Signal analysis of rotating machinery

As shown above, the selection of suitable signal processing methods depends on the characteristic of the noise and vibration signals emitted from the component being tested. A main characteristic of signals emitted from rotating machinery is its synchronicity to the rotation angle. This synchronicity can be used to provide stable input signals for the assessment metrics. This chapter explains the processing of angle equidistant signal processing methods as basic analysis methods for rotating machinery.

Angle synchronous digital resampling

The graphic shows a typical application of digital resampling within an order analyzer:

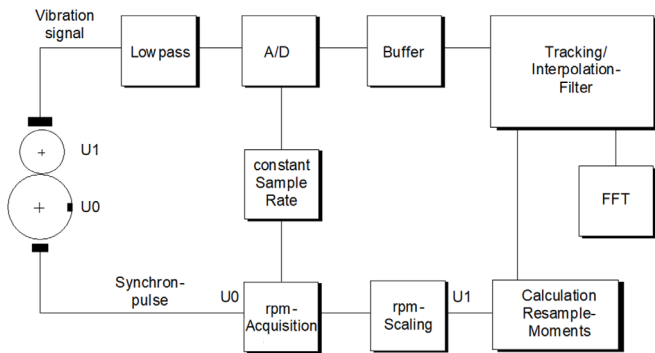

Figure 8. Digital resampling within an order analyzer.

Interpolation of angle-equidistant sample time instants on time axis

The goal of this processing step is determining the time instances that should be used as new sampling points for the angle-equidistant sampled signal.

The input signal is a tacho signal; for instance, a series of encoder pulses acquired from an appropriate tacho sensor. The usage of a model with a constant acceleration between two synchronization pulses is based on the constantly accelerated rotary motion. The figure illustrates the determination of the sampling graphically:

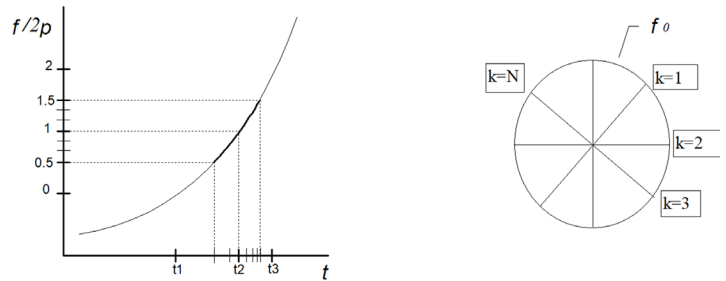

Figure 9. Interpolation in time domain.

The algorithm works correctly for linear speed changes between two known angles or between two synchronization pulses. With rapid changes in speed, it is necessary to have high standards for accuracy and resolution of the speed measurement. Therefore, a reasonable number of high-precision angles are needed as well as high-quality tacho acquisition hardware. Angle-related errors have a greater impact in this regard to the higher order harmonics at high order resolutions. To provide reliable angle information at high revolution speed, typical signal sampling rates of 100 to 500 kilohertz (kHz) are not enough. The tacho signal should be sampled at 20 megahertz (MHz) or higher.

Interpolation on the amplitude axis

If the time instant of a certain angle is determined, the amplitude value of the vibration signal at this time instant must be calculated. This is possible by using a finite impulse response (FIR) low pass with two independent time axes, one time-equidistant for the input and one angle-equidistant for the output.

For optimizing calculation expense, a FIR-filter with a variable sample count is used. The impulse response of the low pass will be stretched or pushed depending on the revolutions per minute (RPM) value.

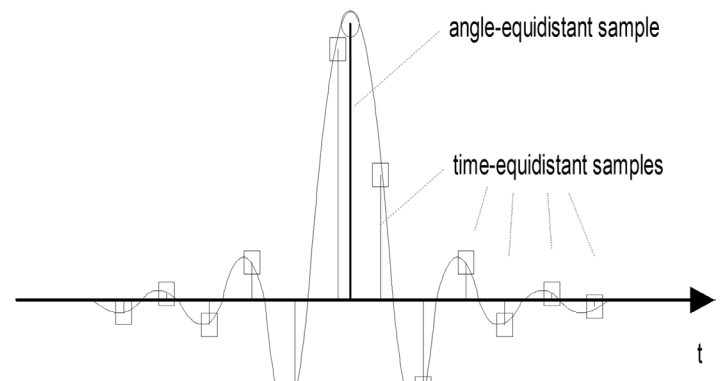

Figure 10. Interpolation of angle-synchronous signals.

Angle domain signal processing

Based on the angle-synchronous resampled signal, other signal processing methods are used to analyze the sensor signal. The goal of these analysis functions is to separate signal components coming from the device being tested against other signal components originated by the test bench environment.

Order spectral analysis

The most common method is called order spectral analysis. This analysis function transfers the signal from angle domain to order domain. The result could be an averaged order spectrum or an order-related signal versus time or revolution speed.

The averaged order spectrum is calculated over a defined period or test step. It represents the average level of each individual order. The averaged order spectrum is well-suited for issues that occur over the entire test step independent from other parameters.

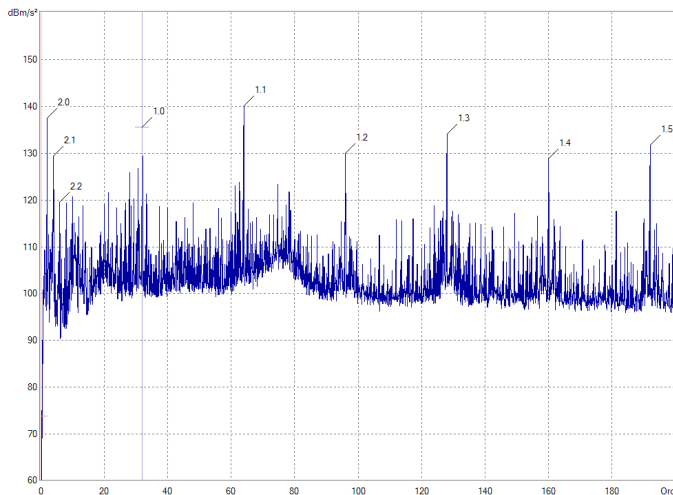

Figure 11. Averaged order spectrum.

If changes over time or speed are of interest, a level track should be used. This level track also can take harmonics and side band lines into account.

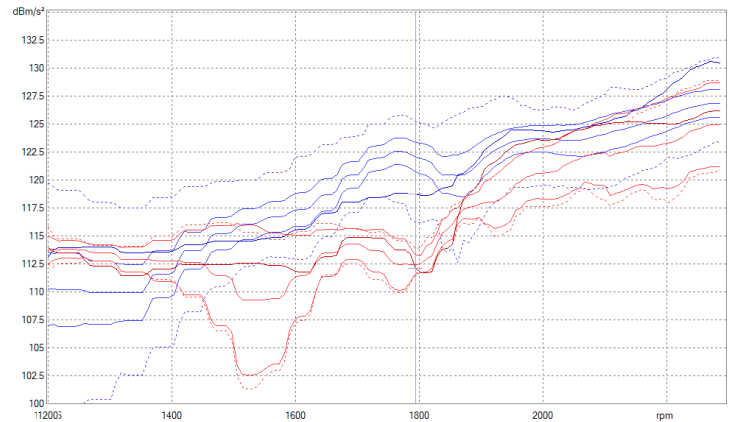

Figure 12. Order level track versus speed.

Analysis in angle domain

Like time-frequency representations, high resolution in order direction and in angle direction are physically not possible under end-of-line test conditions. So, for analysis of transient signals with a certain angle period, the angle synchronous averaged envelope is a suitable analysis function.

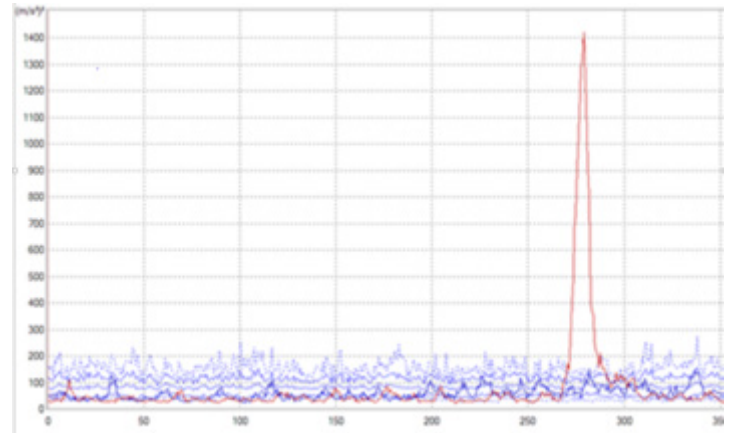

Figure 13. Angle synchronous averaged envelope.

Extraction of metrics

Finding the right analysis function to extract signals originated from a certain component is only the first step. To identify a certain issue or a certain faulty component, metrics have to be defined. The metrics make use of the high selectivity of the analysis functions to assess only signal components that are generated by a certain component or caused by a certain issue. Typical metrics are:

- Single order or frequency levels
- Harmonic or sideband levels of orders, frequencies, quefrenicies or 1/orders
- Relations between spectral lines, such as sideband energy measures
- The position of a transient signal component in time- or angle-domain representations
- The position of a spectral line in the angle synchronous order cepstrum

The following example shows how a sideband energy measure can help to detect a gear geometry issue at the timing drive of a commercial engine.

The picture below shows a part of the averaged order spectrum around the third harmonic of the timing drive's gear mesh order. The gear mesh harmonic, order 96 and the sideband lines caused by the meshing gears are clearly visible. They also can be assigned to the single gear wheels.

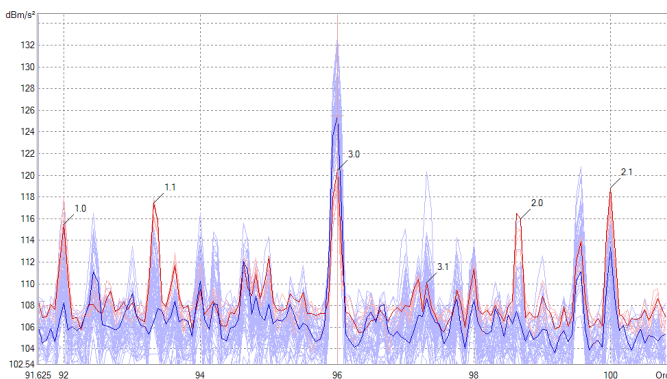

Figure 14. Averaged order spectrum (zoom).

The blue lines show the production reference at the end-of-line test bench. The red line show engines with gear noise issue caused by the gear geometry.

There is no line in the order spectrum where the red lines are outside of the scatter of the blue lines. Therefore, a direct metric based on an order line cannot be defined.

But the red lines have a different behavior regarding the distribution of order levels than the blue lines: All measurements of faulty engines have a low level of the gear mesh order and relatively high levels of the sideband lines. This is caused by the poor geometry of the tooth gears. While the gear mesh order basically shows the overall behavior of the tooth gear, the sideband lines are caused by modulation and show the deviation of single teeth from the averaged tooth geometry.

Based on this information, a new metric can be defined. In this case a so-called sideband energy measure is used, where the relation of the gear mesh line level and the averaged level of the sideband lines is calculated. The following picture shows the statistics of the sideband energy measure for the engines shown in the previous picture.

It is clearly visible the results from the engines with gear issues are outside of the production scatter so that a reliable limit can be defined.

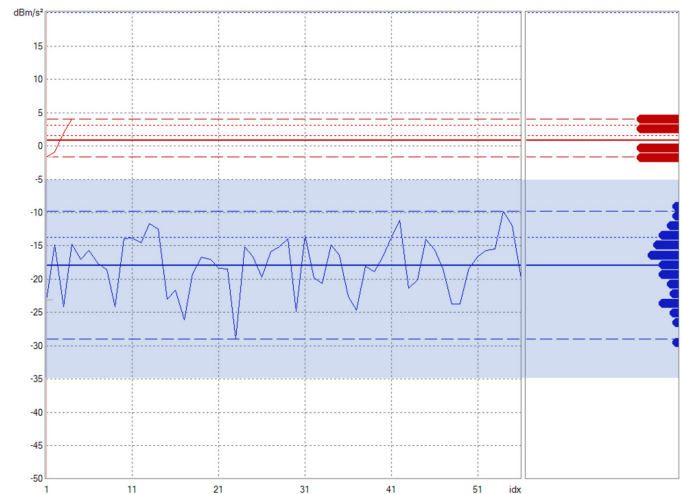

Figure 15. Sideband energy measure.

Automatic definition of limits

Developed for nondestructive material testing, statistical classification methods are also used at the end-of-line test. There are several reasons for using automatic methods for limit definition:

- Reduction of manual configuration work for setting and maintaining limits and limit curves
- Setting up automatic limits to be able to detect new issues at their first occurrence. This is important to achieve a zero fault production

This work can be done continuously with automated methods, while the quality engineer can use his or her expertise to directly improve the classification results.

The principle

Using a statistical method for automatic limit adaptation has some advantages compared to pure artificial intelligence (AI) based methods:

- No training, but adaptation
- No labeled data required
- Easy to handle, easy to understand

Quality metrics are calculated from a measurement signal and evaluated using limit curves. The algorithm calculates the limit curves from a series of measurements by statistical evaluation of the quality characteristics.

The statistical evaluation depends on the distribution density functions of the respective characteristic. For the simple case of one, a Gaussian-distributed characteristic, it is sufficient to use mean and standard deviation. With an increasing number of measurements used for the calculation of statistical moments, their fidelity increases. It may be useful to already have a few test objects; for example, for the pilot series to support an initial assessment.

Once the limit curves are determined, the statistical algorithm can adjust the limit curves accordingly to adapt the process development within predefined tolerance ranges. This automatic "drift adaptation" not only supports the quality engineer. It enables the current production to be checked with narrower limits as it can be realistically feasible with manual setup.

The advantage of the operator is that fine errors can be reliably detected, which are otherwise within the tolerance band. Precise automatic adaptation helps in this case to avoid pseudo errors.

Of course, statistical methods work with scalar (for example, correlation, level) as well vectorial quality metrics (spectrum, time signal). Tools for visualizing the adaptation history are available.

There are different ways to use this approach. So, it can make sense to only allow adaptation when special events are fulfilled; for example, when a quality characteristic reaches a predetermined warning limit. Another variant is the support of non-Gaussian features.

Industrial implementation

The vibro-acoustic evaluation in the end-of-line test of automotive components is an integral part of quality assurance. In addition to the customer's requirement for objective and complete control of conspicuous noises and vibrations, the driving force is the goal to guarantee excellent product quality at reasonable expense. The information obtained during the inspection opens up the possibility of improving the quality standards of the respective production line in a targeted manner. In addition to the quick amortization of the vibro-acoustic test technology, the position of the supplier is strengthened by a high-quality standard.

When looking at sensor technology and signal analysis, the changed requirements due to the increasing importance of e-mobility requires sophisticated approaches that easily can be handled by the quality engineer.

A final section deals with evaluation procedures and the resulting opportunities to continuously adapt vibration and noise-based quality control to the requirements of production with manageable effort and to guarantee excellent product quality.

With Simcenter™ Anovis™ software, which is part of the Xcelerator™ portfolio, the comprehensive and integrated portfolio of software and services from Siemens Digital Industries software, we provide a solution that is able to fulfil these requirements. Simcenter Anovis is designed for use in the field of industrial quality testing.

Conclusion

The vibration and noise testing of vehicle components meet the noise-level requirements of customers. At the same time, the supplier is able to optimize production processes and increase overall quality.

Based on these two fundamental requirements, specified test systems have been established and are in use in several production environments.

The required technology is available, modular and adaptable to different application scenarios without sacrificing usability. In test-bench specification, vibration and noise testing gain an increasingly important role. As the methodology becomes more widely used, it will play a role for test personnel by providing sophisticated automatic functions to define new features for fault identification. The vibro-acoustic assessment will increase product quality at the end-of-line test in the future. Closer links between development and production processes may contribute to better knowledge transfer for future generations of products.

Siemens Digital Industries Software

Headquarters

Granite Park One
5800 Granite Parkway
Suite 600
Plano, TX 75024
USA
+1 972 987 3000

Americas

Granite Park One
5800 Granite Parkway
Suite 600
Plano, TX 75024
USA
+1 314 264 8499

Europe

Stephenson House
Sir William Siemens Square
Frimley, Camberley
Surrey, GU16 8QD
+44 (0) 1276 413200

Asia-Pacific

Unit 901-902, 9/F
Tower B, Manulife Financial Centre
223-231 Wai Yip Street, Kwun Tong
Kowloon, Hong Kong
+852 2230 3333

About Siemens Digital Industries Software

Siemens Digital Industries Software is driving transformation to enable a digital enterprise where engineering, manufacturing and electronics design meet tomorrow. The Xcelerator portfolio helps companies of all sizes create and leverage digital twins that provide organizations with new insights, opportunities and levels of automation to drive innovation. For more information on Siemens Digital Industries Software products and services, visit [siemens.com/software](https://www.siemens.com/software) or follow us on [LinkedIn](#), [Twitter](#), [Facebook](#) and [Instagram](#). Siemens Digital Industries Software – Where today meets tomorrow.

[siemens.com/software](https://www.siemens.com/software)

© 2021 Siemens. A list of relevant Siemens trademarks can be found [here](#). Other trademarks belong to their respective owners.

83143-C3 1/21 A