

NX Mach Series add-on modules

Extending product development features and capability of NX Mach Series solutions

Benefits

- Extend features and capabilities of the NX Mach Series
- Configuration through process-, industry- and application specific tools
- Flexible token-based licensing

Summary

The NX Mach™ Series software offers preconfigured solutions targeted to specific product development disciplines and problems. You can extend and enhance the functionality of the Mach Series with add-on modules. These add-ons enable you to configure your solutions to specific requirements with specialized design tools, standard parts applications, design-integrated simulation solutions, programming and customization toolkits and direct translators.

The "Token licensing" marked add-ons in the product overview are part of the value-based licensing pool. Token licensing provides you with extra flexibility, as you can use the tokens to activate any product that is part of the token pool.

Core applications

NX provides various core functionalities that enable you to exchange data between proprietary systems and NX, check designs in real size with our virtual reality tools and give you an extra boost in usability with Artificial Intelligence (AI) powered command prediction.

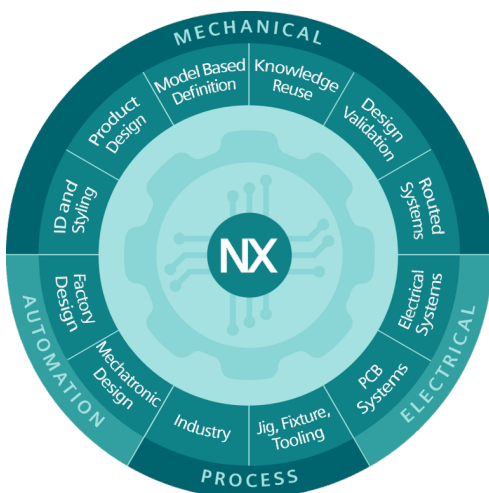

NX STEP AP 242*

Bidirectional translation using the STEP AP242 translation protocol.

NX CATIA V4 translator*

Delivers bidirectional translation between CATIA V4 and NX. Users can access files from the file open, file save as, file import and file export dialogs. This tool flattens assemblies to a single level on both import and export.

NX CATIA V5 translator*

Provides bidirectional translation and reads CATPart and CATProduct files. This tool reads coordinate systems, points and part substructure, geometry, assembly structure and, attributes of data of color, layer and name into NX.

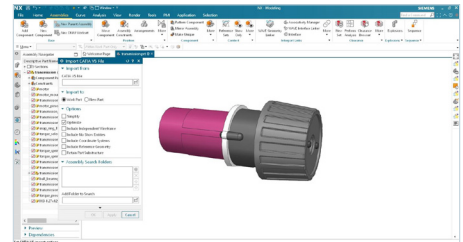

NX Pro/E Interface*

Reads native Pro/E and CREO solids and surfaces from *.prt and *.asm files and creates an NX part or assembly.

NX ACIS Translator*

Two-way data exchange between NX and CAD models in the ACIS modeling kernel format.

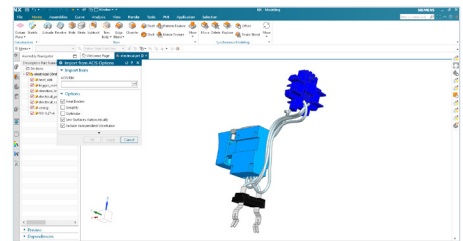

*Token licensing available

NX Mach Series add-on modules

NX Translator for IFC

Bidirectional translation using the Industry Foundation Classes (IFC) file format, which describes architectural, building and construction data.

NX Command Prediction*

The machine learning/ artificial intelligence enabled user interface can predict and serve up commands to the user based on learned command usage patterns. It allows design environment personalization by considering the differences in knowledge, style and preferences. Leveraging and sharing of learned command usage data enable a reduced learning curve, promote use of domain and or industry-specific best practices and increase productivity.

NX Viewer*

With NX Viewer, NX models and drawings can be opened, viewed and measured in the native NX format. This is ideal for users who have access and need to view NX data, but do not intend to save or re-author NX data.

NX DMU and Markup*

Provides access to digital mockup (DMU) and markup functions including create DMU workset, create snapshot, manipulate snapshot, insert product, move in work set, reset to design state and add markups.

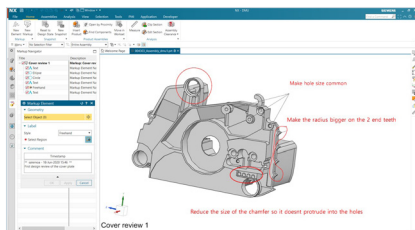

NX DMU & Markup Add-on for NX Viewer*

Provides the NX Viewer user with the ability to perform digital mockup functions.

NX Virtual Reality Review

The NX Virtual Reality Review license provides integrated immersive studies and design review capabilities. Users can review designs with the help of a virtual reality (VR) headset and VR-supported hardware.



NX Virtual Reality Collaborate

When used together with NX VR Review, this add-on supports multi-user NX VR sessions. Any number of NX Virtual Reality Review users can join a single collaborate session. The NX VR multi-user collaboration server synchronizes operations that each participant performs.



Mechanical

Industrial design and styling

Create aesthetically appealing, innovative products with fast concept design, free-form shape modeling and surfacing capabilities including subdivision modeling, class-A surfacing and reverse engineering. Enhanced visualization with both dynamic and real-time photorealistic rendering tools to create visually stunning models.

NX Realize Shape*

Using subdivision modeling methods, users can create advanced 3D product shapes with unprecedented speed and ease of use. The toolset is equally suited to creating quick 3D concepts or final surface shapes of the highest quality. NX Realize Shape™ is fully integrated with all other NX modeling functions, allowing for seamless incorporation with traditional modeling approaches to achieve a high degree of refinement of the design.

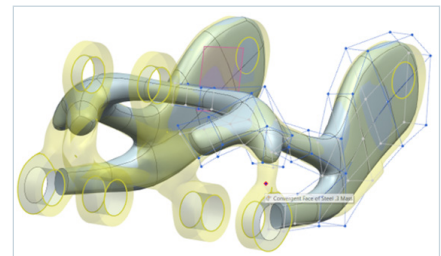

NX Draw Shape*

Enables designers to visually convey and communicate aspects of the design prior to investing in 3D models. This add-on enhances NX capabilities by enabling freehand drawing of wireframe shapes on bodies.



Product design

The core modeling capability of NX combines wireframe, surface, solid, parametric and direct modeling in a single environment that enables designers to choose the most appropriate tool for the task at hand. Pioneering capabilities such as synchronous technology and Convergent Modeling™ technology make it easy to edit designs with simple push-pull methods and work with facet/mesh data in the same modeling environment. The adaptive UI of NX uses machine learning to help designers improve productivity.

NX Layout

This 2D conceptual design solution allows you to take advantage of essential 2D requirements and to leverage a familiar drawing environment. NX Layout provides many dedicated tools to support 2D data migration, 2D design and layout as well as 2D-to-3D capabilities to explore concepts in 2D, iterate and transfer to 3D to generate 3D models and assemblies.

NX WAVE Control*

NX WAVE Control is a geometry linking tool that enables designers to define interpart relationships for parametric assembly modeling. WAVE assembly control structures and constraints help simplify design changes and accelerate modeling of configurations, options and variants.



NX Assembly Path Planning*

The assembly path planning software automatically determines the optimum, interference-free path for extracting a component from an assembly. The resulting path is stored as a set of steps within an assembly sequence. The extraction path can streamline serviceability studies by verifying component access without requiring a physical prototype or extensive analysis.

NX Lattice Structures Design

Often used in additive manufacturing, lattice structures allow weight reduction without compromising structural integrity. NX Lattice Structures Design provides a powerful set of design capabilities including custom lattice cells to suit specific design needs such as improved

strength, rigidity, impact resistance, energy absorption or porosity, as well as custom and randomized lattice structures. Filtering for individual lattice rods and creation of special tetrahedron surface and volume lattice structures is possible.

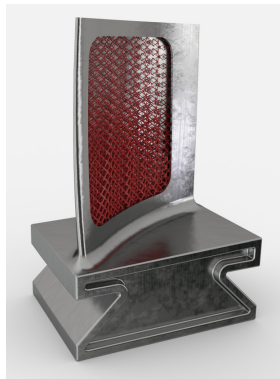

NX Structure Designer*

Create structural frames more efficiently with its easy-to-use structural frame modeling capability. You can create structural frames in minutes by leveraging the frame drawing assistant, which can create 2D skeletons with minimal clicks.

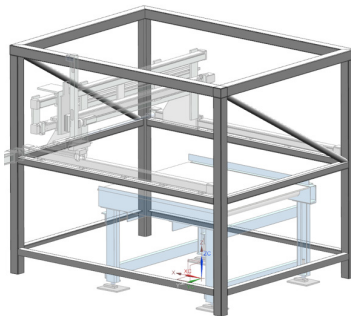

NX Topology Optimization for Designers

This design optimization tool can be used to automate the improvement of structural designs, while still meeting the various performance, material and manufacturing requirements. It contains powerful optimization capabilities including the ability to set up and perform an optimization on a single component or system assembly, the ability to add various design and manufacturing constraints to control the results of the

optimization, such as design symmetry, offset, shelling, blending, additive overhang angles, additive self-supporting, and additive material spreading, molding, casting, machining and extrusion.

NX Advanced Sheet Metal*

Users can model complex sheet metal parts that contain drawn features and nonlinear bend lines. The advanced flange function allows easy creation of nonlinear flanges using customer input parameters or existing geometry to define shapes and specify end limits. The completely revised joggle function enables complex joggles to be added to flanges or tabs including single and multiple jogs. The flat pattern feature provides rich data for downstream consumption.

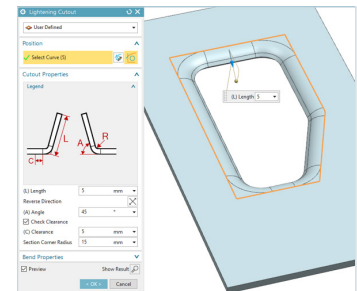

NX Fabric Flattener*

Designed to generate flat patterns for woven or unidirectional fabric materials. It can be used to flatten composite laminate plies, or any materials that conform to the theoretical models for woven or unidirectional fabrics.

NX Human Modeling*

Designers can create feature models of human beings, which can be used to explore and verify how people interact with product designs. The human models can then be used to explore and verify how people interact with product designs all within the NX environment.

NX Human Modeling Posture Prediction*

Specifically aimed at the automotive industry, posture prediction allows users to position a model of a human driver, front passenger, or rear passenger in a statistically accurate seated position inside an automotive vehicle. Users specify the position of the hands and feet in a specific location, such as the driver's hands and feet touching the steering wheel and brake pedal and the model then predicts an occupant's hip location, eye locations and arm and leg positions based on the type of vehicle and the occupant's hand and foot locations.

NX Weld Assistant*

Creates weld, structural adhesive and mechanical connection features. It includes resistance spot welds, mechanical clinches, arc welds in the shape of fillets, butt, J, V, bevel and flared bevel. Sealer beads can be generated with any cross-sectional shape and spray-on adhesive, mastic or glue can be defined. There are validation checks for all discrete weld types along with import and export capability. An automatic annotation function generates standard weld symbols and PMI, and all weld features can be published to Teamcenter when running in managed mode.

NX Drawing Automation*

Provides a framework for developing a company-specific drawing automation solution. With this framework, users can define a highly customized set of rules for creating drawings to specification. Also included are tools for developing custom templates used to automate the drawing process.

NX Physical Architecture Diagram Author*

Used for model-based systems engineering (MBSE), this add-on helps with managing and tracing large numbers of product and technical requirements throughout the design process. It can show connections such as WAVE links,

assembly constraints and dimensions between components of a 3D assembly and reports on the status of requirement checks on measurement. The package can be used standalone in NX or in conjunction with Teamcenter MBSE parameter management.

NX Physical Architecture Diagram Viewer*

The viewer shows connections such as WAVE links, assembly constraints and dimensions between components of a 3D assembly and reports on the status of requirement checks on measurement.

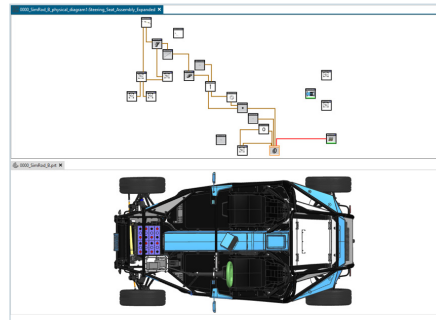

NX Physical Parameter Management Author*

Also used for MBSE, this add-on manages mechanical requirements and measures results for master 3D and CAE models. It enables users to create and report on measurements in the CAD model and also reports status of checks on values from CAE results performed in other applications such as Simcenter™ 3D software.

NX Physical Parameter Management Viewer*

The viewer displays reports on measurements in the CAD model and also reports status of checks on values from CAE results performed in other applications such as Simcenter 3D.

NX Reference Point Cloud View

NX Reference Point Cloud View allows users to visualize point cloud files in the point database (POD) format. The software enables designers to easily add

referenced point cloud objects into layout models (for example from NX Line Designer and ship design applications) and perform various operations on the point clouds including measurements and clipping. NX Reference Point Cloud View helps improve virtual planning workflows and reduces the number of errors during the physical implementation.

NX Join*

Reduces the time to place and define fasteners and hardware, while improving the quality of the fastener assembly design. Users can define standard join features with information and attributes about the connection between assembly components. NX Join covers the basic definition of point-based connections including rivets, bolts, adhesives, and spot welds.

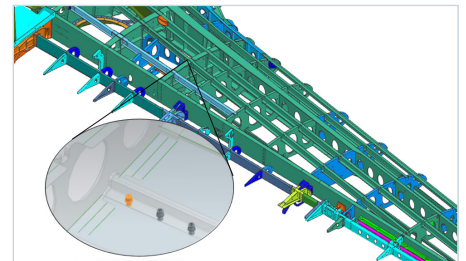

NX OmniFree Transformer

Morph surfaces to points or curves in the NX environment. The points/curves compensate for springback which occurs during stamping.

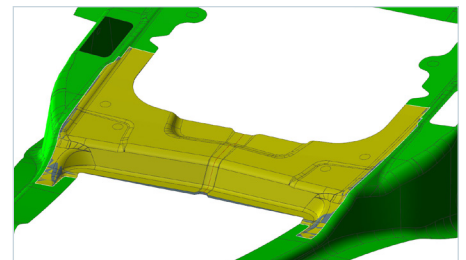

NX OmniMesh Transformer

This add-on is used for tool morphing, providing capabilities to morph surfaces to CAE meshes, STL or point clouds in the NX environment. The mesh/STL/point cloud compensates for springback which occurs during stamping.

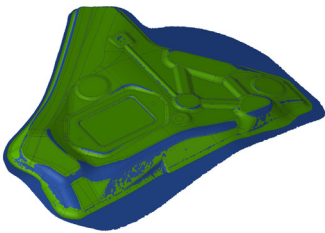

Model-based definition

Model-based definition capabilities in NX enable the production of a complete digital definition of a product within a 3D model. By empowering the model as the single source of truth, NX reduces the time spent on engineering documentation, drives downstream tools for validation and manufacturing, and reduces late changes and scrap.

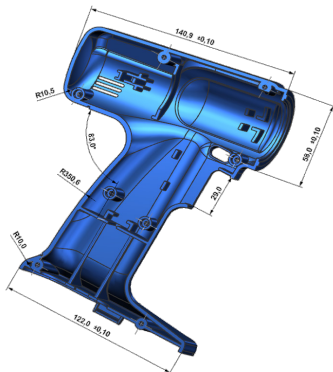

NX PMI Effectivity*

NX PMI Effectivity helps users who design products that contain a large number of variations determine which product and manufacturing information (PMI) on a model is relevant for each product configuration. NX PMI Effectivity adds the ability to infer the effectivity of PMI objects based on the geometry referenced by the PMI. This will enable the display of only those PMI objects that are relevant to the selected configuration of the product.

*Token licensing available

NX Technical Data Package

A technical data package can contain important technical data such as models, drawings, associated lists, specifications,

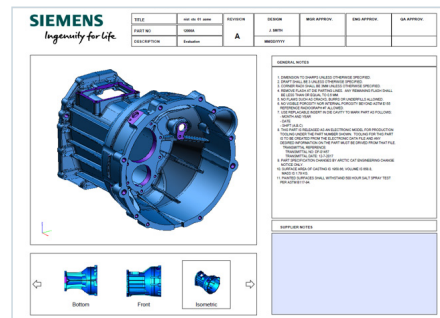

standards, and performance requirements. NX Technical Data Package provides functionality to create, modify, save, store and re-use technical data package templates and to publish technical data packages to industry-recognized formats, JT plus PDF and 3D PDF.

Knowledge re-use

The knowledge re-use capabilities in NX such as a 3D search engine shorten design cycles, reduce development costs, and improve productivity. With knowledge-driven automation capabilities, your company can capture, re-use, and consistently apply best practices across product lines.

NX Product Template Studio Author

Templates can be used to modularize a design, breaking a complex assembly into manageable modules that can then be recombined as needed to configure complex products. NX Product Template Studio Author can add a user-defined interface to any parametric model, which allows parametric models to be intuitively described and packaged for later re-use.

NX Product Template Studio Consumer*

Display and interact with user-defined template interfaces created by the

Product Template Studio Author application. This consumer license will also enable the template model user interface to be automatically invoked as template models are consumed from the NX Reuse Library.

NX Open Toolkits Author

NX Open is a collection of application programming interfaces (APIs) that enable custom applications for NX through an open architecture using well-known programming languages (C/C++, Visual Basic, C#, Java, and Python). Complex and repetitive tasks can be automated, third-party applications integrated and the NX interface customized.

NX Open for .NET Author

The NX Open for .NET Author license provides the NX .NET API libraries, documentation, and utility tools required to create .NET custom applications.

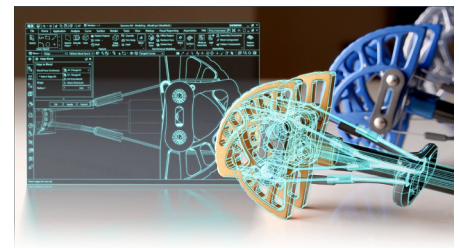

NX Open Python Author

The NX Open Python Author license provides the NX Python API libraries, documentation, and utility tools required to create Python custom applications.

NX Open Dialog Designers

NX Open Dialog Designers provide the application modules, visual dialog builder, libraries and documentation necessary to interactively construct production-quality dialogs for use in the NX environment and supported platforms. The dialog designer consists of two design tools: the Block Styler, which provides interactive tools to design block-based dialogs, and the User Interface Styler, which provides various widgets to construct a dialog for use in the NX environment.

NX Open GRIP Author

Graphics Interactive Programming (GRIP) is a programming language that enables automated operations in NX. In some cases, GRIP can perform advanced, customized operations in a more efficient manner than using NX interactively. NX Open GRIP Author provides GRADE (GRIP Advanced Development Environment) for editing, compiling and linking GRIP programs.

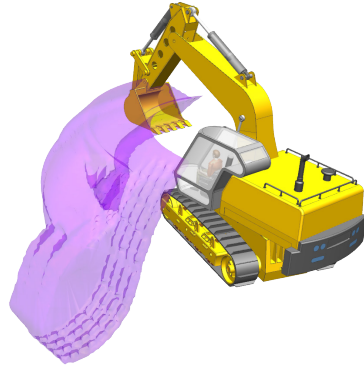

Design validation

NX provides powerful visual product analytics and validation tools that enable you to quickly synthesize information, check designs for compliance to requirements, and make informed decisions. Integrated design-for-manufacturing checks significantly reduce engineering change orders (ECOs), manufacturing defects, costs and delays. With design-integrated motion, structural, and thermal simulation tools in NX, you can quickly compare design alternatives and optimize performance characteristics from the earliest stages of the design process.

NX Animation Designer*

With this easy-to-use motion simulation application designers can model the kinematic behavior of any product with moving parts in a time-based manner. This application helps designers gain a better understanding how the product will operate and determine clearances between parts during movement. NX Animation Designer can also be used to create disassembly animations for visually appealing product presentations.

NX Simcenter FLOEFD

A full-featured 3D computational fluid dynamics (CFD) analysis solution, which enables design engineers to work directly on their CAD models to prepare and evaluate CFD simulations of fluid flow and heat transfer.

NX EasyFill Analysis

This integrated mold flow simulation tool enables designers to analyze part and mold designs during early stages of design. The analyses can be done with a pioneering 3D technology and through high-performance 3D filling simulation.

NX EasyFill Analysis – Advanced

Validates mold designs prior to manufacturing through capabilities such as multi-gate analysis, packing, shrinkage, fiber orientation and others. In addition to these capabilities, simulation preprocessing and postprocessing are performed inside the NX CAD environment.

NX Check-Mate Author

NX Check-Mate provides an automated, customizable tool that helps users proactively improve product quality. The customization capabilities deliver reliable model and part checking and make sure that your CAD data meets your expectations.

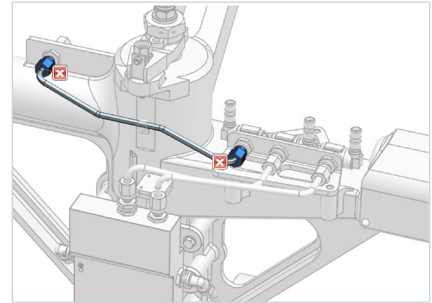

NX DFMPro

This validation add-on executes design-for-manufacturability (DFM) checks on your CAD model by using a one-button click to identify potential problem areas. This check returns valuable information about model integrity with respect to downstream manufacturing processes. The checks include coverage of injection molding, casting, sheet metal, tubing, general machining and assembly.

NX VDA 4955 Checker*

The Association of German Automobile Industry (VDA) add-on checks the quality of curves, faces, solids and drawing data in an NX part file. It verifies that curves and surfaces are in compliance with international standards and local country regulations.

NX HD3D Visual Reporting*

NX HD3D Visual Reporting software inputs information of interest from your company's data sources directly into the 3D product design environment. The capability helps designers make unambiguous assessments, interpret information more accurately and synthesize product and process data rapidly into correct design decisions. NX HD3D Visual Reporting comes with a set of pre-defined, out-of-the-box reports that provide design teams with answers to commonly asked questions. Reports related to ownership, check out, part maturity, projects, load status, validation status and more are available for instant use. With the authoring capability, companies can create and modify custom reports to extract and present the data.

NX One-step Formability Analysis*

NX One-step Formability Analysis provides a quick and accurate finite element modeling (FEM) sheet metal forming analysis, while also providing tools for creating flattened blanks and pre-forms from complex freeform geometry.

Routed systems

NX digital product development solutions include an integrated suite of tools that facilitate the entire design process for routed systems, including wire harnesses, cables, piping, tubing, conduit and raceways. These process-specific tools reduce detailed design time, improve product quality and transfer product information seamlessly between the logical design, physical design, analysis, manufacturing and service sectors.

NX Routing Base*

NX Routing Base provides core capabilities used by all NX routed system design solutions. This includes all of the general capabilities needed to create, edit copy and move paths. It also includes tools for defining standard part libraries, selecting parts from libraries and intelligently placing standard parts within the paths. It also enables designers to define standard stock specifications and assign them to paths.



NX Routing Piping and Tubing*

Optimizes piping and tubing design workflows through intelligent path creation, specification-driven part selection, smart part placement, collision detection, weight calculations and knowledge rules that concurrently validate designs against company and industry standards. The product supports both rigid and flexible pipes and tubes.

NX Routing HVAC*

NX Routing HVAC delivers 3D tools for creating, modifying, validating and documenting HVAC systems. It optimizes HVAC design workflows through intelligent path creation, specification-driven part selection, smart part placement, collision detection, weight calculations, duct splits, duct size calculation and knowledge rules that concurrently validate designs against company and industry standards. The product supports pre-defined catalogs of HVAC parts and parametric templates that can be modified on-the-fly (smart sizing) to fit any space constraints. Together with other NX capabilities like hangers and sheet metal flat patterns, this product provides a complete lifecycle solution for HVAC design.

NX Piping Fabrication Drawings and PMI

An add-on to NX mechanical routing that creates 3D PMI information and corresponding piping isometric drawings from piping models. All the necessary information for downstream fabrication is captured in the form of dimensions and annotations from the 3D model. Custom parts lists can also be created for the fabrication drawings. Existing PMI views with dimensions, annotations and tables can be updated based on changes to the 3D model.

NX Penetration Management*

NX Penetration Management provides an interface for creating, managing and responding to penetration requests between different user groups responsible for steel structures and routed system design. The process begins with a routed system designer (such as a piping designer) who requests pipe penetrations through structures that are designed and maintained by a different design group such as a structure group. A penetration request defines the location of the required cutout and initiates a workflow that can be customized by the end user

to meet specific needs. A typical workflow includes several review steps that must be completed before the cutout can be created to satisfy and close the request.

NX P&ID Designer

Designers can create piping and instrumentation diagrams with this 2D authoring tool. The application includes authoring capabilities, libraries, connectivity validation, 2D to 3D integration and object-level data management using Teamcenter. Companies adopting NX P&ID Designer can expect to realize a faster, more flexible design and change process for reduced design costs and faster times to market.

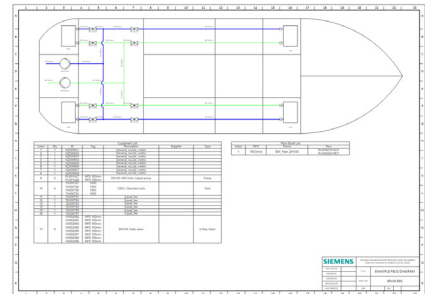

Electrical

Electrical systems

NX offers advanced software tools for the complete development of electrical systems, from electrical/electronic architecture definition, through detailed electrical design and wire harness manufacturing, to documentation and diagnostics.

NX Routing Cabling*

Helps with routing electrical cables in a product assembly along with typical mechanical parts and supporting equipment such as conduit and raceways. It can automatically find paths that have been routed between devices and can assign the cable descriptions to the path segments. Actual cable lengths and diameters can be automatically added to the connection list for feedback to upstream ECAD applications or downstream to manufacturing applications.

NX Routing Harness*

Designers can route an electrical wiring harness consisting of bundles of wires and specify typical mechanical parts and supporting equipment such as connectors and other devices. The software can also import the wiring characteristics for connections between electrical devices. Actual wire lengths and diameters can be automatically added to the connection list for feedback to upstream ECAD applications or downstream to manufacturing applications.



PCB systems

NX provides an environment for the design of both flexible and rigid printed circuit boards (PCBs). Based on workflows common to the design of printed circuit boards, the PCB design tools help model printed circuits rapidly and accurately in the context of an assembly and send the outlines to manufacturing or to an ECAD system for further refinement.

NX PCB Exchange

NX PCB Exchange provides a foundation for intuitive and efficient design of rigid and flexible printed circuits. PCB Exchange allows direct connection with all major printed circuit board (PCB) design applications, supporting various PCB data interchange formats (IDF, ProStep EDMD Schema IDX) and manufacturing formats (ODB++, GenCAD).

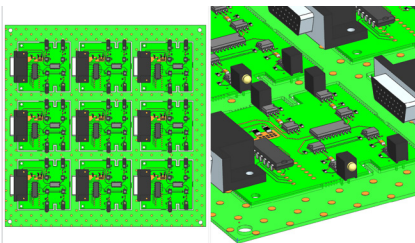

NX PCB Exchange for Zuken

Transmits information between NX and Zuken CR-5000 and CR-8000 PCB design software. Data such as the board outline, hole placements, component placements, keep-in and keep-out regions can be transmitted back and forth using a format native to the Zuken product. The software also enables enhanced data exchange concerning board layers, copper trace geometry and bend region geometry.

NX Flexible PCB

The PCB design tools help model printed circuits rapidly and accurately in the context of an assembly and send the outlines to manufacturing or to an ECAD system for further refinement. The printed circuit model developed in NX can be checked for clearances and tolerances, and then the finished board model can be transferred to an ECAD system for component placement or circuit trace or layer development.

Process-based applications

Jigs, fixtures and tooling

Automate the entire tool development process including part design, tool assembly layout, and detailed tooling design and validation using advanced NX functionality. With step-by-step guidance and associativity to part designs, you can work with even the most challenging tooling and fixture designs.

NX Mold Wizard*

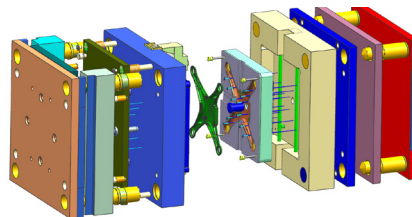

Designs can be created quickly and efficiently with this complete working environment of supporting functions and component data for mold designs. A process thread approach is employed to identify and develop the critical functions

required to complete mold design tasks. The process thread approach includes the implementation of tools that simplify, automate and guide users through the tasks involved in the design of plastic injection molds.

NX Feature2Cost – Stamping

The NX Feature2Cost add-on provides the capabilities needed to analyze the

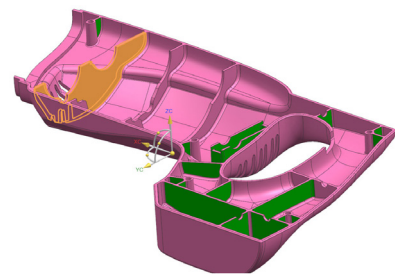

product design and identify key features such as bends, embossing and sheet metal thickness that influence the manufacturing of stamping tools. Once the features are analyzed and identified, the information is transferred to Teamcenter tool costing software to estimate manufacturing costs.

NX Feature2Cost – Mold*

Helps users to analyze the product design and identify key features such as ribs, openings, cores/cavities, side cores and others that influence the manufacturing of injection molds. Once the features are analyzed, the information about these features is transferred to Teamcenter tool costing to estimate the cost to manufacture the injection molding tools.

NX Flow Blend

Enables designers to create robust constant or variable blends along multiple complex faces with small curvature that are essential for manufacturing.

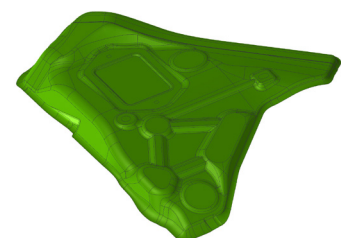

NX Electrode Design*

A time-saving, step-by-step solution that streamlines design and production of electrodes for electrical discharge machining (EDM). This solution helps automate and effectively design, validate, document, manufacture and manage the entire electrode development process from design through production.

NX Progressive Die Wizard*

The NX Progressive Die Wizard add-on offers the tools to construct progressive stamping dies. When planning the forming process, designers can define the pre-process, unfold the part and perform formability analysis (using One-step Formability Analysis), nest the flat pattern (blank layout), design the scraps, and determine the strip and tool layout.

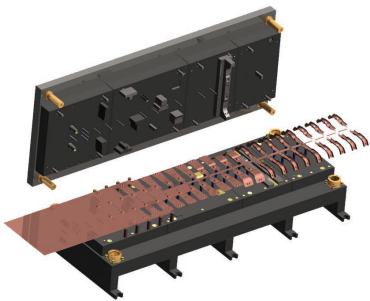

NX Die Structure Design*

Assists tool designers with specific tools for creating blank, draw, trim and flange dies and associated transfer equipment for stamping sheet metal parts.

NX Die Engineering*

The Wizard-like environment provides process-specific tools for die face design.

NX Molded Part Validation*

Analyzes parts and automatically provides designers with information about draft angles, undercut areas, sharp corners, small radiuses and other items that could compromise molding quality. It also provides designers with an easy visual check of core and cavity sides.

Industry-specific applications

NX delivers workflow solutions built for the specific needs of individual industries with modules for aero structure design, vehicle design automation, ship structure design, human modeling and automation engineering of production systems.

NX General Packaging*

The VDA software (General Packaging) is a set of software assistants and advisors that automate a wide range of tasks associated with the mechanical, safety, vision and occupant packaging of a vehicle. The vehicle design automation functionality checks designs for compliance with international standards and local country regulations.

Fibersim*

The Fibersim™ portfolio includes special-purpose tools for engineering and manufacturing parts from fiber-reinforced

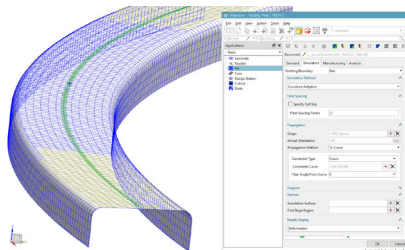

composite materials. The software delivers a 3D environment that supports a concurrent engineering process in which design and analysis are performed in the context of the manufacturing process.

Mastertrim

The Mastertrim™ add-on provides tools for engineering transportation seating and interiors that efficiently define, communicate and maintain a complete and single representation of the automotive seat and interior components across disciplines. Once the master model is defined, Mastertrim provides upstream

and downstream benefits, including enabling concurrent engineering, early cost feedback, quicker and more reliable changes, styling criteria verification and the reduction of design iterations.

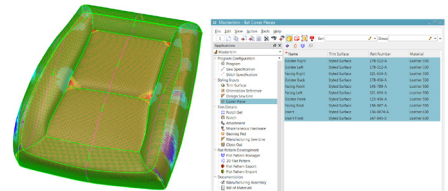

NX Aerospace Design*

NX Aerospace Design offers a set of tools (aero step, aero rib, aero shelf, aero flange), specifically tailored for designing aerospace parts. NX Advanced Sheet Metal tools for the creation of non-straight brake parts are also included.

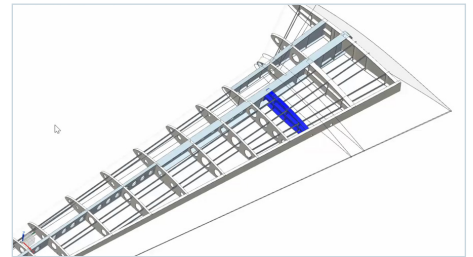

NX Ship Structure Basic Design*

Designers can quickly model a preliminary macro view of the ship based on inputs available from the concept design stage. Users can easily model and modify a structural macro view of the ship to support early design-stage analysis, drawing generation and transition to detail design. The basic design model includes hull, plate and profile systems that can be further split with seams into smaller subsystems. Designers can define decks, bulkheads, pillars, stiffeners and edge reinforcements. Standard parts, brackets and cutouts can be added to the basic design model. The resulting models can be used in gross material estimates and weight and center-of-gravity calculations. The basic model transitions seamlessly to detail design.

NX Ship Structure Detail Design*

NX Ship Structure Detail Design provides tools needed to define and modify ship structural detail parts. It includes parametric detail feature definition for quick placement and modification of plates, stiffeners, brackets, holes, profile cut-outs, clips and collars, chamfers, end cuts, corner features, edge features and flanged plates. It also supports creation of structural pillars and application of insulation material to steel surfaces. All data generated from detail design can be used for the generation of manufacturing and production planning outputs.

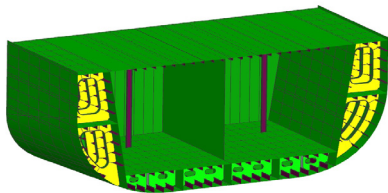

NX Ship Structure Manufacturing Preparation*

NX Ship Structure Manufacturing Preparation enables creation of data for structural part fabrication. Manufacturing parts can be created from the detail design parts within a manufacturable unit can be restructured to organize parts and enable welds distribution within the manufacturing assembly structure.

NX Ship Drafting*

Aids in the creation of ship drawings required for classification approvals. Users can create frame bars on drawing views along with shipbuilding-specific baseline dimensioning methods. Ship section drawing views can be automatically annotated to include stiffener section symbols, structure ID symbols, filling lines representations, scantling information and continuity symbols. Designers can add annotations to each ship structure object and control color, fonts and widths of the ship structure lines.



NX Ship General Arrangement Design*

Ship designers can create quick and accurate proposals for new ships based on customer requirements during the concept design phase. It provides tools for creating a 3D model of the general arrangement of a ship and its corresponding 2D drawings. The application

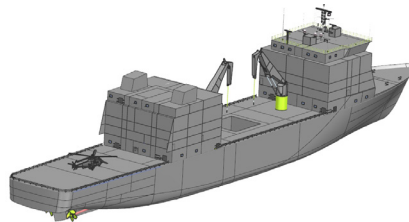

includes the capability to initialize the general arrangement design process based on a configurable product structure along with the definition of the concept grid model and the deck-based breakdown of the ship. Each deck can then be detailed by individual designers into room spaces based on a specific purpose. Net and gross volume and surface area for each space is calculated. The ability to add standard equipment, parts and accommodation-related items from the reuse library to these spaces is also provided.

NX Issue Management

Adds an interface inside NX for integrating directly with Teamcenter-based Issue Management capabilities. The tool enables NX users to directly create, edit, and manage issues, as well as associating 2D images and other files with issues.

NX Rules-Based Structure Welding*

Enables shipbuilders to automatically define welds in the 3D model. This application generates a lightweight object to represent each weld joint, enabling very large quantities of welds to be defined and worked with in NX. The software creates weld joints automatically based on the 3D part geometry and material, including the placement and bevel configuration. Supports varying bevels, 3D edge preparations, automated product manufacturing information (PMI) and drawing weld symbols.

Automation

Mechatronic design

NX provides a multidisciplinary approach to machine design that breaks down barriers between electrical, mechanical and automation engineers. With a library of joints, motors, sensors and actuators along with kinematic and dynamic properties for each component, machine designers can rapidly perform a physics-based, interactive simulation to verify machine operation.



NX Mechatronics Concept Designer*

NX Mechatronics Concept Designer (MCD) delivers a functional design approach to build concept models that combine mechanical, electrical and software components based on system-level product requirements. It enables early conceptual design capabilities in the disciplines of mechanical, electrical, and automation design and engineering and their associated parallel interdisciplinary workflows, supporting a coarse-to-fine product development process.

NX MCD Player*

A read-only viewer and simulation player for models created with MCD software. The player enables users to load and play simulations of mechatronic machines. Additional signal mapping capabilities are available to drive simulations using programmable logic controller (PLC) hardware or virtual software simulations of a PLC.

Factory design

With NX you can quickly design and visualize layouts of production lines and associate them to manufacturing planning. You can easily optimize the process by specifying each production step down to managing a single manufacturing resource, such as a robot or fixture. Perform accurate impact analysis and drive efficient change management by using a library of parametric resources.

NX Line Designer

The powerful manufacturing layout solution is integrated with Teamcenter fourth-generation design (4GD) or manufacturing process planning. It delivers a rich library of parametric equipment including racks, conveyors, safety equipment and material handling equipment that can be used with Teamcenter Classification.

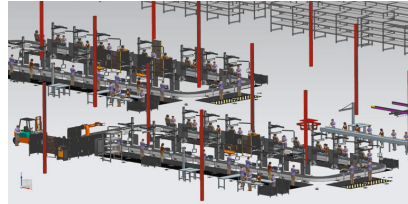

NX Automation Designer

With this solution for electrical and automation engineering of factory lines and machines, designers can re-use model geometry of NX designs to structure devices, configure controls hardware and validate engineering results.

NX Automation Designer – Electrical Design

Provides model geometry and property re-use of NX designs and enables designers to structure devices in independent aspects, name and reference designation rules and validate engineering results.

NX Automation Designer – Cabinet Design

This add-on to NX Automation Designer (Electrical Design) enables designers to create mounting layouts in 3D and perform collision analyses.

NX design products key add-ons overview

Content is subject to change

	Token licensing
Core	
NX STEP AP242 translator	Yes
NX CATIA V4 translator	Yes
NX CATIA V5 Translator	Yes
NX Pro/E Interface	Yes
NX ACIS Translator	Yes
NX Translator for IFC	
NX Command Prediction	Yes
NX Viewer	Yes
NX DMU and Markup	Yes
NX DMU & Markup Add-on for NX Viewer	Yes
NX Virtual Reality Review	
NX Virtual Reality Collaborate	
Mechanical	
<i>Industrial design and styling</i>	
NX Realize Shape	Yes
NX Draw Shape	Yes
<i>Product design</i>	
NX Layout	
NX WAVE Control	Yes
NX Assembly Path Planning	Yes
NX Lattice Structures Design	
NX Structure Designer	Yes
NX Topology Optimization for Designers	
NX Advanced Sheet Metal	Yes
NX Fabric Flattener	Yes
NX Human Modeling	Yes
NX Human Modeling Posture Prediction	Yes
NX Weld Assistant	Yes
NX Drawing Automation for NX	Yes
NX Physical Architecture Diagram Author	Yes
NX Physical Architecture Diagram Viewer	Yes
NX Physical Parameter Management Author	Yes
NX Physical Parameter Management Viewer	Yes
NX Reference Point Cloud View	
NX Join	Yes
NX OmniFree Transformer	
NX Omnimesh Transformer	
<i>Model-based definition</i>	
NX PMI Effectivity	Yes
NX Technical Data Package	
<i>Knowledge re-use</i>	
NX Product Template Studio Author	
NX Product Template Studio Consumer	Yes
NX Open Toolkits Author	
NX Open for .NET Author	
NX Open Python Author	
NX Open Dialog Designers	
NX Open GRIP Author	
<i>Design validation</i>	
NX Animation Designer	Yes
NX Simcenter FloEFD	
NX EasyFill Analysis	
NX EasyFill Analysis – Advanced	
NX Check-Mate Author	
NX DFMPRO	
NX VDA 4955 Checker	Yes
NX HD3D Visual Reporting	Yes
NX One-step Formability Analysis	Yes

Mechanical (continued)

	Token licensing
<i>Routed systems</i>	
NX Routing Base	Yes
NX Routing Piping and Tubing	Yes
NX Routing HVAC	Yes
NX Piping Fabrication Drawings and PMI	
NX Penetration Management	Yes
NX P&ID Designer	

Electrical

	Token licensing
<i>Electrical systems</i>	
NX Routing Cabling	Yes
NX Routing Harness	Yes
<i>PCB systems</i>	
NX PCB Exchange	
NX PCB Exchange for Zuken	
NX Flexible PCB	

Process

	Token licensing
<i>Jig, fixture, tooling</i>	
NX Mold Wizard	Yes
NX Feature2Cost – Stamping	
NX Feature2Cost – Mold	Yes
NX Electrode Design	Yes
NX Progressive Die Wizard	Yes
NX Flow Blend	
NX Die Structure Design	Yes
NX Die Engineering	Yes
NX Molded Part Validation	Yes

Industry

	Token licensing
NX General Packaging	Yes
Fibersim	Yes
Mastertrim	
NX Aerospace Design	Yes
NX Ship Structure Basic Design	Yes
NX Ship Structure Detail Design	Yes
NX Ship Structure Manufacturing Preparation	Yes
NX Ship Drafting	Yes
NX Ship General Arrangement Design	Yes
NX Issue Management	
NX Rules-based Structure Welding	Yes

Automation

	Token licensing
<i>Mechatronic Design</i>	
NX Mechatronics Concept Designer	Yes
NX MCD Player	Yes
<i>Factory design</i>	
NX Line Designer	
NX Automation Designer	
NX Automation Designer – Electrical Design	
NX Automation Designer – Cabinet Design	

Siemens Digital Industries Software
siemens.com/software

Americas +1 314 264 8499
Europe +44 (0) 1276 413200
Asia-Pacific +852 2230 3333